

**Warning:** to prevent fire or shock hazard, do not expose camera or monitor to rain or moisture.



The lightning flash with arrowhead symbol, within a triangle, is intended to alert the user to the presence of uninsulated “dangerous voltage” within the product’s enclosure; that may be of sufficient magnitude to constitute a risk of electric shock to persons.



**Caution:** to reduce the risk of electric shock, do not remove cover (or back). No user serviceable parts inside. Refer servicing to qualified service personnel.



The exclamation mark within a triangle is intended to alert the user to the presence of important operating and maintenance (servicing) instructions in the literature accompanying the appliance.

## Electro Magnetic Compatibility (EMC)

This equipment complies with the European rules EMC according to EN55013, EN55020 and EN50082-1.

The equipment conforms with the EMC directive and low-voltage directive.

This device complies with EMC rules under test conditions that included use of system cables and connectors between system components. If you have any problems, contact your dealer.

## Warning

*Any unauthorized modification to this equipment may cause violation of the EMC rules resulting in the revocation of the authorization to operate the equipment.*

**Note:** we advise you to use the following types of mains power adapters in combination with the camera:

U.K. Philips VCM1162/01R  
EUR Philips VCM1162/00R

## Important notes for users in the U.K.

If the fitted plug is not suitable for your mains socket, it should be removed and be replaced by an appropriate plug.

### How to replace a plug

- Cut the mains plug from the lead.
- Strip the sheathing so the wires will become free for the necessary length to connect the UK-mains plug (not supplied).

The wires in the mains lead are coloured according to the following code: blue=neutral (N), brown=live (L). As these colours may not correspond with the colour markings identifying the terminals in your plug, proceed as follows:

- Connect the blue wire to the terminal marked N or coloured black.
- Connect the brown wire to the terminal marked L or coloured red.

### Caution

Do not connect either wire to the earth terminal in the plug, marked E (or) or coloured green (or green and yellow).

Before replacing the plug cover, make certain that the cord grip is clamped over the sheath of the lead, not simply over the two wires.

### Fuse

If the mains plug (or adapter) contains a fuse, the value of this fuse should be 3 Amp. Alternatively, if another type of plug (not fused) is used, the fuse at the distribution board should not be greater than 5 Amp.

# Colour Observation Monitor

## Table of contents

	Page
<b>Introduction</b> .....	<b>3</b>
<b>Connection and operation facilities</b> .....	<b>4</b>
<b>Installation</b> .....	<b>4</b>
<b>Placement and connection</b>	
<b>Settings</b>	
Cable length selector	
Last in line switch	
Input selection switch	
<b>Operation</b> .....	<b>6</b>
<b>Power on/off</b>	
<b>Power save/active</b>	
<b>Alarm</b> .....	<b>6</b>
<b>Monitor is used as slave monitor</b>	
When an alarm occurs	
Reset alarm	
<b>Monitor is used as stand-alone system</b>	
Trouble shooting	
<b>System cable</b> .....	<b>7</b>
<b>Tips for maintenance</b> .....	<b>7</b>

## Introduction

By purchasing our 'Colour Observation Monitor' you possess an easy to operate set for expansion of your observation and security system with more observation posts.

Used as a slave monitor it provides the same camera image and sound as the system monitor. The monitor is fitted with a loop-through connector to which a following slave monitor can be connected.

The 'Colour Observation Monitor' can also be used as a stand-alone system. In this way you can use the slave monitor as a one camera surveillance system. The monitor provides an input for a Philips system camera. The monitor also has an auxiliary input which can be used for any video and audio baseband signal, such as a VCR (playback only).

### The following items are included in this kit:

- 1 Colour Observation Monitor
- 1 System cable (25m/75ft)
- 1 User manual

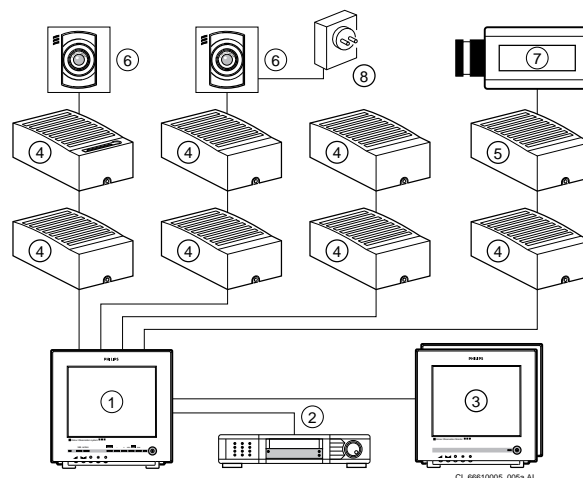

- 1 System monitor
- 2 Video recorder (VCR)
- 3 Slave monitor(s) (max. 3)
- 4 Accessory boxes (0-2 per cable)
- 5 Interface box
- 6 System cameras
- 7 Non system camera's (CVBS)
- 8 Mains power adapter

### Mains supply:

The monitor accepts a mains power voltage of 100-240V~, 50/60Hz.

When the monitor is used as a stand alone system, it supplies a safe low-voltage (16-32V ---) for a camera.

Read these instructions, before putting your system in operation.

## Connection and operation facilities

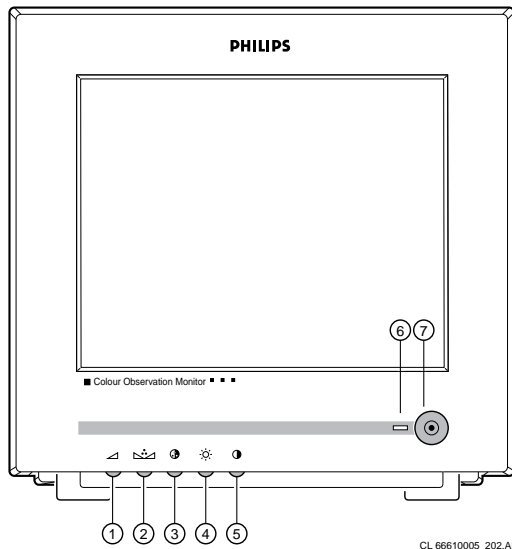

- 1 **Volume** Volume control for the audio signal.
- 2 **Hue** Hue control  
*Remark: For the Europe version this control has no function.*
- 3 **Colour** Colour intensity control
- 4 **Brightness** Brightness control
- 5 **Contrast** Contrast control
- 6 **System mode indication LED**  
The following modes are possible:
  - power on (LED is green)
  - power save mode (LED is red)
  - silent function (LED is amber)
  - alarm during power silent function (LED is red blinking)
- 7 **Power save/active** Image and audio of the monitor on/off.

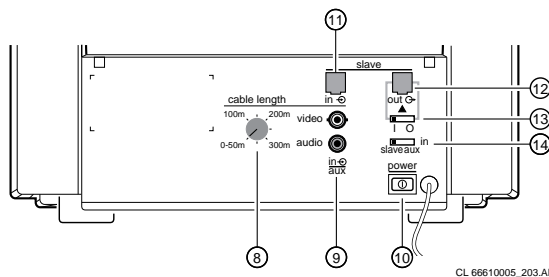

- 8 **Cable length selector (cable length)**  
The value of this selector must be set to the length of the system cable (0-300m max.) between the slave monitor and system monitor.

- 9 **Aux. in (aux. in)**  
Input for a third party camera or VCR (playback only).
- 10 **Mains power switch (power)**  
Switches the slave monitor on/off.
- 11 **Slave input (slave in)**  
This input has to be connected to the output of the system monitor.  
*Remark: When the slave monitor is not connected to a system monitor (stand alone) you can use this input to connect a system camera.*
- 12 **Slave out (slave out)**  
Output for a second or third slave monitor.
- 13 **Last in line switch (slave out 1/0)**  
Set the switch to 1 if another slave monitor is connected to this output.
- 14 **Input selection switch (in slave/aux)**  
With this switch you can select which input is displayed on the monitor screen.

## Installation

In this chapter the installation of the slave monitor is described.

*Caution: When (dis)connecting the slave monitor always ensure that the slave monitor and system monitor are switched off by means of the rear power switch. Only operating the power save button is not sufficient.*

### Placement and connection

- 1 Place the slave monitor on a solid base (leave at least 3cm around each side of the monitor for ventilation).

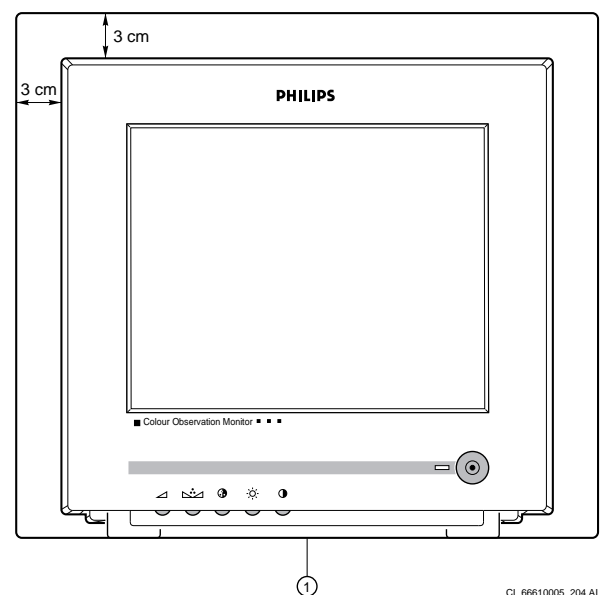

- 2a Monitor is used as stand alone system:  
Connect a system camera to the **slave-in** input (11).  
A third party camera can be connected to the **aux. in** input (9).
- 2b Monitor is used as slave monitor:  
See figure at the top of the page.  
Connect the slave monitor to the system monitor (16).  
**Remark:** If a second slave monitor is used, it has to be connected to the **slave-out** (12) output.
- 3 Check and adjust the settings of the following controls:
  - Cable length compensation selector (8)
  - Last in line switch (13)
  - Input selection switch (14)
 Read the 'settings' section for the correct control settings.
- 4 Connect the slave monitor to the mains (15).
- 5 Switch on the main power switch (10).

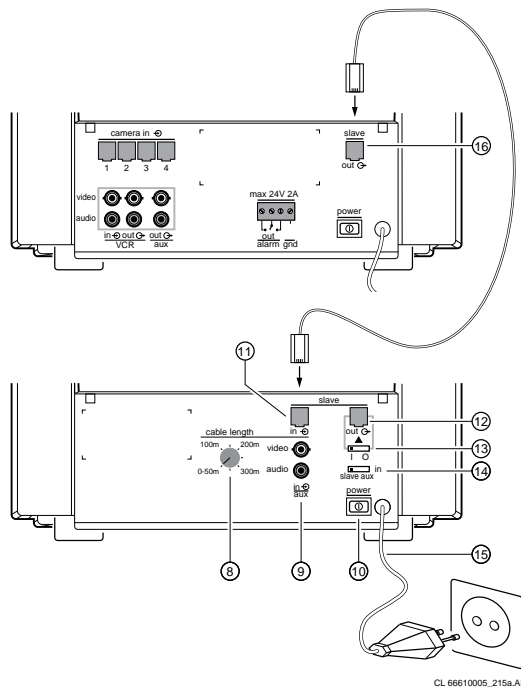

## Settings

There are three controls located at the back of the slave monitor. By means of these controls the slave monitor can be adapted to the configuration of your observation system. These controls are:

### Cable length selector

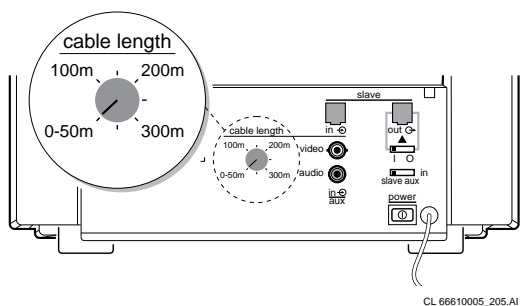

This selector adapts the slave monitor input to the length of the system cable connecting system monitor and slave monitor. This to optimize the picture and sound quality.

Set the cable length selector switch to the correct cable length. The length set must be the same as the length of the system cable between slave monitor and system monitor. The max. allowed cable length is 300m/900ft.

### Last in line switch

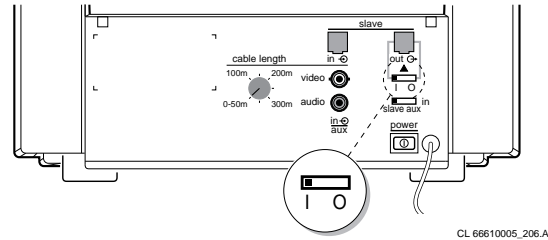

- Set this switch to **0** when the slave-out output is not used (this monitor is last in line).
- Set this switch to **1** when you connect a (second) slave monitor.

### Input selection switch

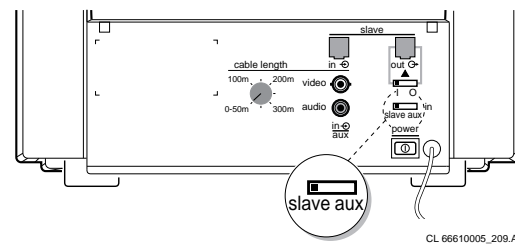

With this switch you can select which input is displayed on the monitor screen.



- The **slave-in** input is selected.  
The slave monitor reproduces the image and sound of the system monitor.  
**Remark:** When the slave monitor is used as a stand alone system the image and sound of the Philips system camera are reproduced.



- The **aux-in** input is selected.  
When you have connected a non system camera or VCR to this input, its image and sound will be reproduced.

## Operation

### Power on/off

Push button at the rear of the monitor.

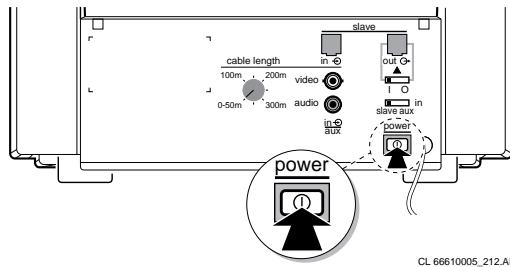

#### 1 Power on

The slave monitor switches on.

**There are two possibilities:**

- The system monitor is in power save mode. The slave monitor starts in power save mode (system mode indication LED is red).
- The system monitor is in active mode. The slave monitor performs the same image and sound as the system monitor (system mode indication LED is green).

#### 2 Power off

The monitor switches off (system mode indication LED is off).

### Power save/active

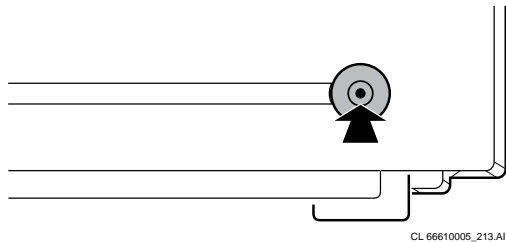

#### 1 Power active

Image and sound of the monitor are switched on (system mode indication LED is green).

#### 2 Power save

Image and sound of the slave monitor are switched off. The system mode indication LED is red. When the system monitor is in silent mode, the system mode indication LED is amber.

When an alarm occurs and the system monitor is in non-silent mode, the slave monitor switches on (system mode indication LED is green).

**Remark:** When the system monitor is switched to power save the slave monitor will also switch to power save.

Press  to switch the slave monitor to power active again.

## Alarm

### Monitor is used as slave monitor

**When an alarm occurs:**

- 1 The system monitor is in non-silent mode
  - The slave monitor switches automatically to 'power active' if it was switched to 'power save'.
  - The slave monitor reproduces the camera image and sound of the camera input which triggered the alarm.
  - The blinking message "AL" and the camera input number is displayed at the bottom of the monitor screen.
  - A buzzer sounds for max. 3 minutes.
- 2 The system monitor is in silent mode and the slave monitor is in power save mode
  - The system mode indication LED is red blinking.
- 3 The system monitor is in silent mode and the slave monitor is in power active mode
  - The slave monitor reproduces the camera image and sound of the camera input which triggered the alarm.
  - The blinking message "AL" and the camera input number is displayed at the bottom of the monitor screen.

**Reset alarm**

The alarm resets whenever a button is pressed on the system monitor (for more information you should consult the manual of the system monitor).



### Monitor is used as stand alone system

When you use the monitor as a stand-alone system a beep will sound for 3 minutes if:

- a camera cable-short occurs; the camera power is switched off.
  - a cable is cut or a camera is disconnected.
- Accessory boxes cannot be used in this simple stand-alone system.

**Trouble shooting**

If the monitor does not show the camera image, then check the following controls:

- power on/off and power save/active
- input selection switch
- contrast , brightness , colour 

Also check the connection to the monitor input.

## System cable

For the interconnections between the system monitor and slave monitor a system cable is supplied. For an optimum picture and sound quality you should always use 4-wire dual twisted-pair cable when extending the connection (max. 300m/900ft). The cable and plugs are available in the hobby and professional trade. Pay attention that the connectors are fixed to the cable corresponding to the figure below.

**Remark:** When a camera is used and the length of the camera cable is more than 200m/600ft, a mains power adaptor should be used to supply the camera (see accessories). The max. allowed cable length is 300m/900ft)

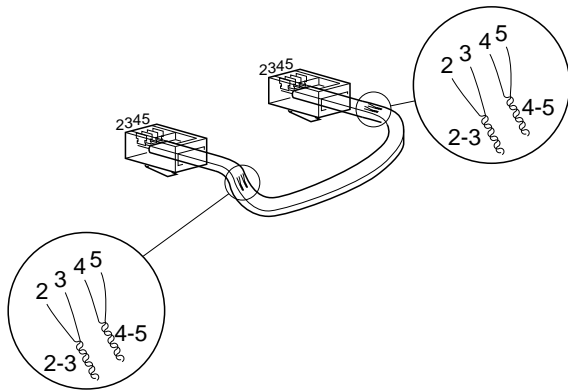

CL 66610005\_006.AI

**Caution:** The plugs used for the observation system have the same dimensions as standard telephone plugs. Never connect telephone equipment to the observation system.

## Tips for maintenance

### Ventilation

Keep ventilation openings free to avoid the monitor for overheating. Do not place the monitor in the immediate vicinity of a heating source.

### Cleaning

You can clean the monitor with a moist fluff-free cloth or shammy leather cloth.

Avoid direct contact with water.

**Warning:** The back of the monitor should only be removed by qualified maintenance personnel.

## Technical specifications

### Colour observation monitor VSS94705T

Picture tube	14", 90° deflection, 0.65mm pitch TV grade
Resolution	320 TVL (4MHz)
TV standard	PAL, 625 lines, 60Hz, 2:1
Mains supply voltage	100 - 240VAC +/-10%, 50/60Hz
Power consumption	78W max.
Camera power supply	16-32V <sub>DC</sub> , short-circuit protected
System synchronisation	Monitor locks to the mains Cameras lock to H, V and PAL indent of the monitor
Inputs	1 (system interface or camera)
Slave monitor output	1 (system interface)
Alarm output	
• 4-pole screwblock	N.O./N.C. contact + system ground
• Contact rating	24V <sub>DC</sub> , 2A
AUX.	
• Video input	BNC (1V <sub>pp</sub> , output impedance 75Ohm)
• Audio input	BNC (0.5V <sub>pp</sub> , output impedance 1kOhm)
System cable	4-wire dual twisted-pair 'telephone' cable
Weight	11,6kg
Dimensions (h <sub>x</sub> w <sub>x</sub> d)	320x350x370mm.
Ambient temperature	
• Operating	+10...+45 °C
• Storage	-25...+70 °C
Ambient humidity	93...98% RH max.

Specifications may change without notice.