

## TABLE OF CONTENTS

Color Television  
**TS3661C1**

*Let's make things better.*



### Getting Started

Warning/Precautions.....1  
 Basic Television Hookups.....1  
 Basic Television and Remote Operation .....2  
 How to Use the Onscreen Menu Controls .....3  
 Setting Up Your Television for the First Time .....3-4

- For details on product registration, warranty, and service refer to the other literature (Owner's Manual) included with your TV information packet. Please retain all these materials and keep them handy for future reference.

**NOTE: This owner's manual is used with several different television models. Not all features (and drawings) discussed in this manual will necessarily match those found with your television set. This is normal and does not require you contacting your dealer or requesting service.**

**WARNING: TO PREVENT FIRE OR SHOCK HAZARD DO NOT EXPOSE THIS UNIT TO RAIN OR EXCESSIVE MOISTURE.**

## HOOKING UP YOUR TV (BASIC ANTENNA/CABLE TV CONNECTIONS)

### CABLE TV

**BEGIN**

#### CABLE INPUT/CONVERTER

Your Cable TV input into your home may be a single (75 ohm) cable, or a Converter Box installation. In either case the connection to the TV is very easy. Just put the threaded end of the cable signal to the TV's antenna plug and screw it down tight.

NOTE: The connecting cable for the Converter is supplied from the Cable TV Company.

**1** If your Cable TV signal is a single round cable (75 ohm) then you're ready to connect to the TV. **If you have a Cable Converter Box:** Connect the Cable TV signal to the Cable Signal IN(put) plug on the Converter.

**2** Connect the Cable TV cable to the ANTENNA/CABLE plug on the TV. **If you have a Cable Converter Box:** Connect the OUT(put) plug from the Converter to the 75Ω plug on the TV.

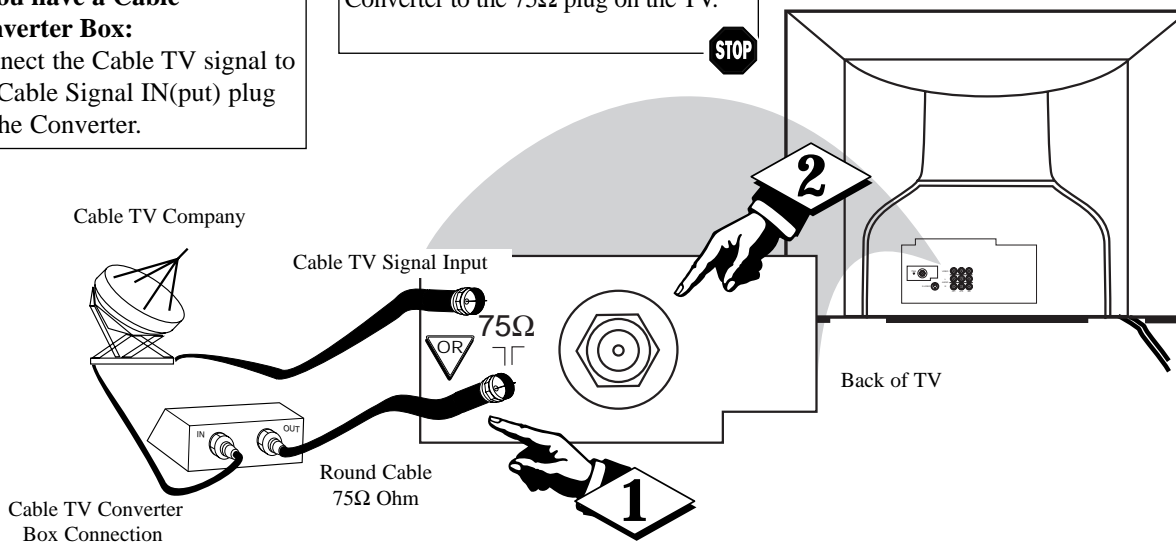

### SMART HELP



Remember: Set the TV for the type signal you've just connected (see the "Tuner" section on page 3 of this Set-Up Guide.)

To select only the channel numbers on your Cable system see "Auto Program" (page 4). If you use a Cable Converter box, set the TV to the same channel as the converter's CH 3/4 switch (on the rear of the converter.)

### ANTENNA

**BEGIN**

#### COMBINATION UHF/VHF

A combination antenna receives normal broadcast channels (VHF 2-13 and UHF 14-69). Your connection is easy since there is only one 75Ω (ohm) antenna plug on the back of your TV - and that's where the antenna goes.

**1** If your antenna has a round cable (75 ohm) on the end, then you're ready to connect it to the TV. **If your antenna has flat twin-lead wire (300 ohm),** you first need to attach the antenna wires to the screws on a 300 to 75 ohm adapter.

**2** Push the round end of the adapter (or antenna) onto the 75Ω plug on the rear of the TV. If the round end of the antenna wire is threaded, screw it down tight.

Note: For homes with separate UHF and VHF antennas you will need an optional combiner to connect to the TV.

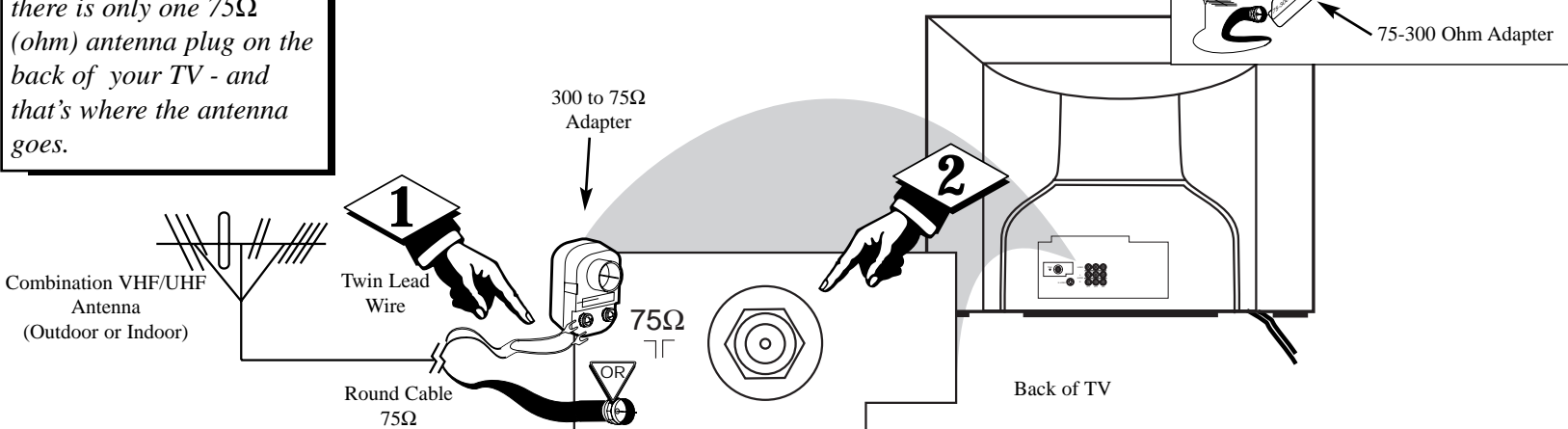

### SMART HELP



Remember, be sure to set the TV for the type signal you've connected (see the "Tuner" section on page 3 of this Set-Up Guide.)

To set the TV to select only the channel numbers in your area see how to "Program" or "Add" channels in memory on page 4 (Auto Program section).

To order any optional accessory contact your dealer or call the toll-free accessory ordering number (1-800-851-8885).

### TV TO VCR

**BEGIN**

#### BASIC CONNECTION

The basic Antenna, or Cable TV, to VCR to TV connection is shown to the right. For more information on other hookups (possible when Cable Converter/Descrambler boxes are included) refer to your accessory VCR and Cable Converter Owner's Manual for details.

**1** Connect your Antenna or Cable TV signal to the IN FROM ANT(enna) plug on the VCR.

**2** Connect the OUT TO TV plug on the VCR to the 75Ω plug on the TV (connecting cable supplied with the VCR.)

**3** Refer to the Owner's Manual included with your VCR for other possible connections and TV/VCR operating details.

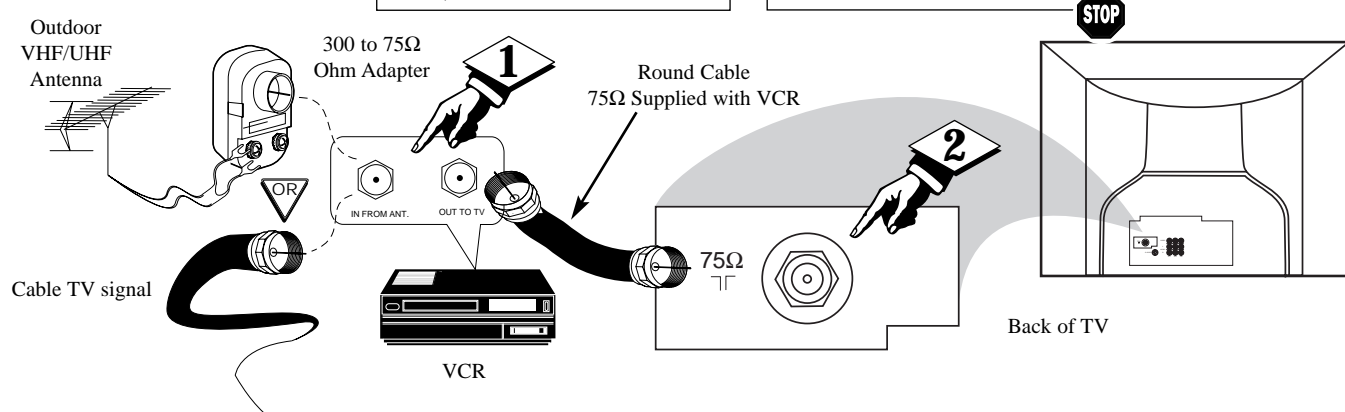

# TV AND REMOTE CONTROL OPERATION

## TELEVISION

**BEGIN**

**1** Press the **POWER** button to turn the TV ON.

**2** Press the **VOLUME +** button to increase the sound level or the **VOLUME -** button to lower the sound level. Pressing both buttons at the same time will display the onscreen menu. Once in the menu, use these buttons to make adjustments or selections.

**3** Press the **CHANNEL UP** or **DOWN** button to select TV channels.

**4** Slide the **TV/VCR/ACC** mode switch on the remote control to the TV position and point the remote at the front of the TV when sending commands.

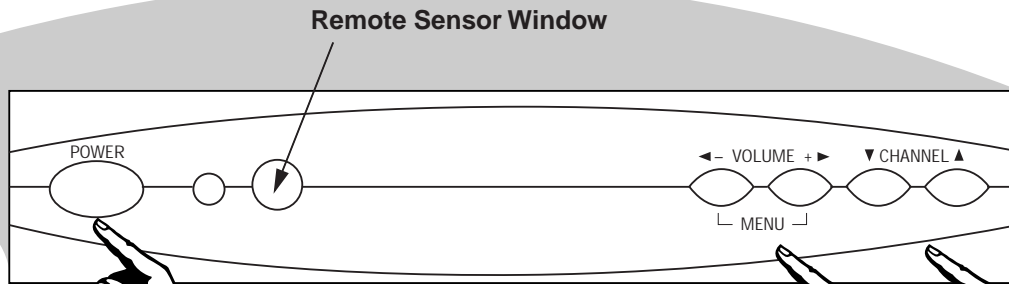
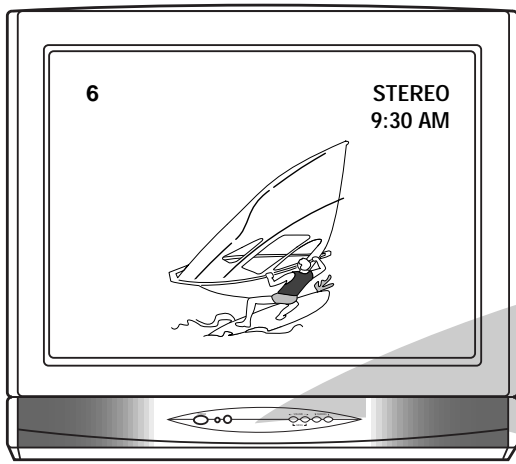

**1**

**2**

**3**

Point the remote control toward the remote sensor window on the TV when operating the TV with the remote.

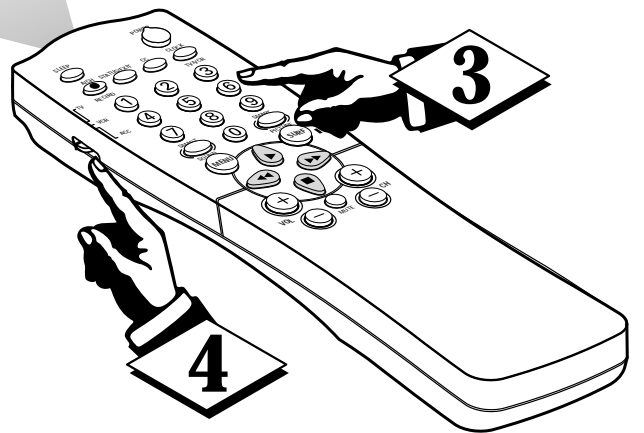

**4**

## REMOTE

### BATTERY INSTALLATION

To load the supplied batteries into the remote:

1. Remove the battery compartment lid on the back of the remote.
2. Place the batteries (2-AA) in the remote. Be sure the (+) and (-) ends of the batteries line up correctly (inside of case is marked.)
3. Reattach the battery lid.

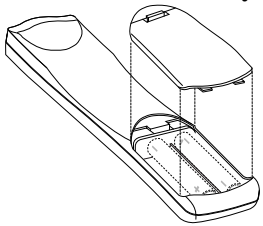

### TV/VCR/ACC MODE SWITCH

The remote's TV/VCR/ACC Switch controls how buttons on the remote are used.

For example:

**With the switch in the "TV" position:**

the Menu, CURSOR **▶▶**, **▶▶**, **◀◀** and **■** buttons are used to select and adjust onscreen TV features.

**With the switch in the "ACC" position:**

the Power, Channel Number, and Channel Up (+) /Down (-) buttons on the remote work with Cable TV Converters.

**With the switch in the "VCR" position:**

the Menu, CURSOR **▶▶**, **▶▶**, **◀◀** and **■** buttons on the remote work Stop, Play, and other VCR features.

**Note:** For more details on how the TV remote works with VCRs and Cable Converters, see the other owner's manual supplied with your TV.

### Sleep Button

Press to set the TV to automatically turn itself OFF. Also can be used as an Enter button when sending channel commands to remote controlled cable converters or VCRs.

### Status/Exit Button

Press to see the current channel number on the TV screen. Also press to clear the TV screen after control adjustments.

### A/CH-Record Button

Press to toggle between the currently viewed channel and the previously viewed channel. When in the VCR mode, press to start the recording of a video tape.

### TV/VCR/ACC Mode Switch

Slide to TV position to control TV functions; VCR to control VCR functions; and ACC for Cable Converter, DBS, DVD, etc. functions.

### SmartSound™ Button

Press to select from a list of SmartSound controls. (Factory preset sound control levels set for different types of listening, based on the type of programming being used.)

### Menu Button

Press for the onscreen menu to appear. Pressing the menu button after menu selections are made will eliminate the menu from the display.

### Cursor Buttons

Use these buttons to select and adjust the TV's onscreen menu. Also used with a VCR for PLAY, FAST FORWARD, REWIND, and STOP.

### Volume (+), (-) Buttons

Press to adjust the TV sound level.

### Mute Button

Press to turn the sound OFF on the TV. Press again to return the sound to its previous level.

### Power Button

Press to turn the TV (or select VCR/Cable Converter) ON and OFF.

### CC Button

Press to select Closed Caption options within the menu. (Refer to the Owner's Manual for details.)

### Clock-TV/VCR Button

When used in the TV mode, the CLOCK-TV/VCR button will access the Clock menu options. Press while in the VCR mode (VCR indicator on the front of the unit will light) to view the playback of a tape. Press again to place in the TV position (VCR indicator light will go off) to view one program while recording another program.

### Number Buttons

Press the number buttons to select TV channels. When selecting single digit channels, press the number of the desired channel. The TV will pause for a few seconds then tune to the selected channel. (Note: you can press "0", then the number also.) For channels "100" and above, first press "1" then the next two numbers of the desired channel.

### SmartPicture™ Button

Press to select from a list of SmartPicture controls. (Factory preset picture control levels set for different types of viewing sources and programs.)

### Surf Button

Press to select previously viewed channels. You can place up to 8 channels in memory. Then by pressing the SURF button you can quickly view the select channels. See the "Surf" section (in your other owner's manual) to see how to select a series of channels using the Surf button. When in the VCR mode, pressing this button will pause the playback of a video tape.

### Channel (+), (-) Buttons

Press to change the tuned channel.

## SMART HELP



Remember, You can press any button on the front of the TV to turn the TV ON.

The tuned channel number will always briefly appear when the TV is first turned ON (and with channel changes.)

You can also press the STATUS/EXIT button (on the remote) to see what channel the TV is ON.

# HOW TO USE THE TV'S ONSCREEN MENU CONTROLS

## MENU

Features for your television can be adjusted from within a MENU shown on the TV's screen. A MENU is nothing more than an On-screen list of features. Each MENU item can be adjusted by viewing the screen and simply press a button.

### BEGIN

**1** Press the **MENU** button on the remote (or the Volume (+) or (-) buttons simultaneously on the TV) to show the onscreen menu.

**2** Press the **CURSOR UP** or **DOWN** buttons on the remote (or the Volume (+) or (-) buttons on the TV) to pick any of the onscreen menu features.

**3** Press the **CURSOR RIGHT** or **LEFT** buttons on the remote (or Channel  $\blacktriangle$  or  $\blacktriangledown$  buttons on the TV) to adjust any highlighted onscreen feature.

**4** Press the **STATUS/EXIT** button on the remote to clear the screen after an adjustment.

You can also just wait a few seconds after you finish the feature adjustment and the MENU will disappear from the screen automatically.

STOP

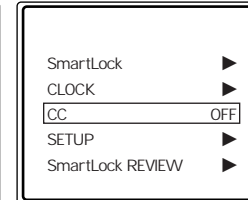
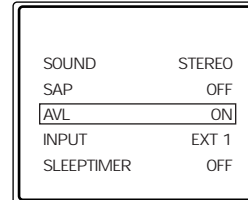
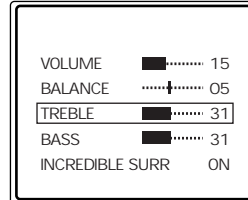
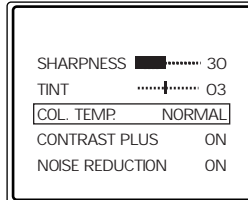
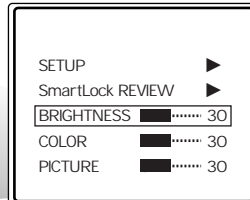

### SMART HELP

If you pass the feature you want, press the **CURSOR UP** or **DOWN** button on the remote to move back through the MENU.

The MENU list is a continuous loop. Once you come to the last item in the list, scrolling down will bring you back to the start of the list again.

The onscreen menu will time out and disappear from the screen when you finish, or you can press the **STATUS/EXIT** button to clear the menu from the screen.

# SETTING UP YOUR TELEVISION FOR THE FIRST TIME

## LANGUAGE

For our Spanish and French speaking TV owners an onscreen LANGUAGE option is present. With the LANGUAGE control you can set the TV's onscreen menu to be shown in either English, Spanish, or French.

### BEGIN

**1** Press the **MENU** button on the remote to show the onscreen menu.

**2** Press the **CURSOR UP** or **DOWN** buttons to scroll through the onscreen menu until the word **SETUP** is highlighted.

**3** Press the **CURSOR RIGHT** button to display the **SETUP** menu features.

**4** Press **CURSOR UP** or **DOWN** buttons to scroll the Setup features until the word **LANGUAGE** is highlighted.

**5** Press the **CURSOR RIGHT** button repeatedly to select **ENGLISH**, **ESPANOL** (Spanish), or **FRANCAIS** (French).

STOP

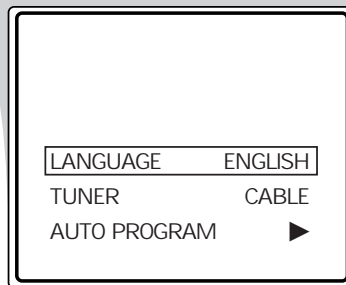
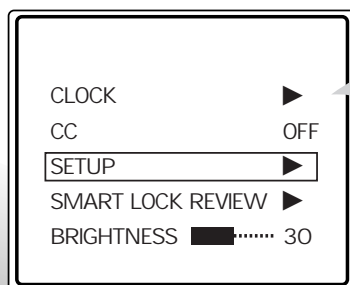

### SMART HELP

Remember: The Language control only makes the TV's onscreen MENU items appear in English, Spanish, or French text.

It does not change the other onscreen text features such as Closed Caption (CC) TV shows.

The onscreen menu will time out and disappear from the screen when you finish, or you can press the **STATUS/EXIT** button to clear the menu from the screen.

## TUNER

The TUNER feature allows you to change the TV's signal input to either CABLE, ANTENNA or AUTO mode. It's important for the TV to know if you want to receive channels from a Cable TV signal or a normal Antenna signal.

Note: The AUTO mode setting helps the TV determine the type of signal or channels being received when AUTO PROGRAM is activated.

### BEGIN

**1** Press the **MENU** button on the remote to show the onscreen menu.

**2** Press the **CURSOR UP** or **DOWN** buttons to scroll through the onscreen menu until the word **SETUP** is highlighted.

**3** Press the **CURSOR RIGHT** button to display the **SETUP** menu features.

**4** Press **CURSOR UP** or **DOWN** buttons to scroll the Setup features until the word **TUNER** is highlighted.

**5** Press the **CURSOR RIGHT** button to select either **CABLE**, **ANTENNA** or **AUTO** mode.

STOP

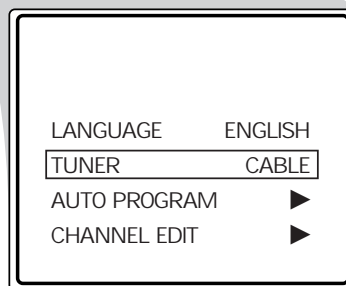
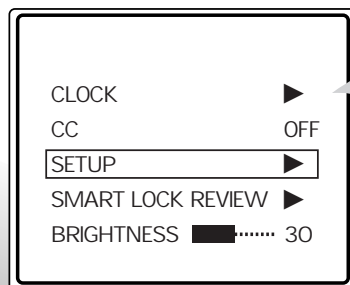

### SMART HELP

Remember, when the AUTO mode is selected the TV will automatically choose the correct type of signal or channels when AUTO PROGRAM is activated.

When CABLE is selected, channels 1-125 are available. When ANTENNA is selected, channels 2-69 are available.

The onscreen menu will time out and disappear from the screen when you finish, or you can press the **STATUS/EXIT** button to clear the menu from the screen.

# HOW TO USE THE SETUP FEATURES

## AUTO PROGRAM

BEGIN

Your TV can automatically set itself for local area (or Cable TV) channels. This makes it easy for you to select only the TV stations in your area when the CHANNEL (+), (-) buttons are pressed.

Note: Make sure the antenna or cable signal connection has been completed before AUTO PROGRAM is activated.

1 Press the MENU button on the remote to show the onscreen menu.

2 Press the CURSOR UP or DOWN buttons to scroll through the onscreen menu until the word SETUP is highlighted.

3 Press the CURSOR RIGHT button to display the SETUP menu features.

4 Press CURSOR UP or DOWN buttons to scroll the Setup features until the words AUTO PROGRAM are highlighted.

5 Press the CURSOR RIGHT button to start the Auto Program scanning of channels

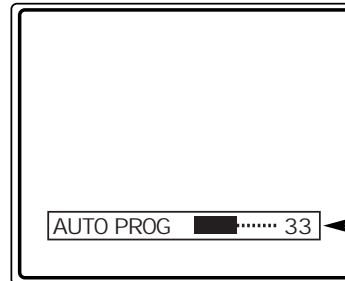
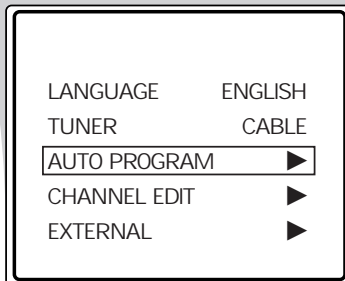
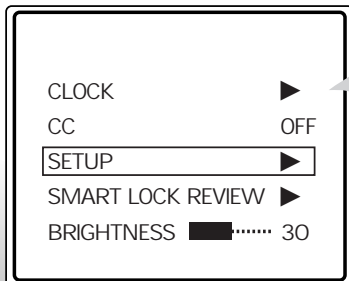

Auto Program will scan for all available channels within the Antenna/Cable signal. When finished, the TV will go back to the SETUP menu.

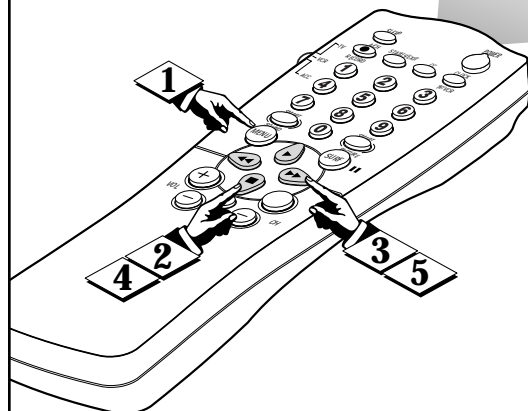

### SMART HELP

Try it out. Press the CHANNEL (+), (-) buttons and see which channels have been added to the TV's memory.

If you want to delete any unwanted channels from the TV's memory, see the CHANNEL EDIT section below.

The onscreen menu will time out and disappear from the screen when you finish, or you can press the STATUS/EXIT button to clear the menu from the screen.

## CHANNEL EDIT

BEGIN

Channel Edit makes it easy for you to ADD or DELETE channels from the list of channels stored in the TV's memory.

1 Press the MENU button on the remote to show the onscreen menu.

2 Press the CURSOR UP or DOWN buttons to scroll through the onscreen menu until the word SETUP is highlighted.

3 Press the CURSOR RIGHT button to display the SETUP menu features.

4 Press the CURSOR UP or DOWN buttons to scroll the Setup features until the words CHANNEL EDIT are highlighted.

5 Press the CURSOR RIGHT button to display the CHANNEL EDIT options.

6 With the CHANNEL EDIT options displayed, and the word CHANNEL highlighted; enter the channel number (with the NUMBERED or the CURSOR RIGHT or LEFT buttons) you wish to ADD, or DELETE from the TV's memory.

7 Scroll down (using the CURSOR UP or DOWN buttons) to highlight the word SAVED. Now use the CURSOR RIGHT button to toggle between YES or NO. If YES is selected the menu reads "CHANNEL ADDED" and the channel is added to the TV's memory. If NO is selected the menu reads "CHANNEL DELETED" and the channel is deleted from the TV's memory.

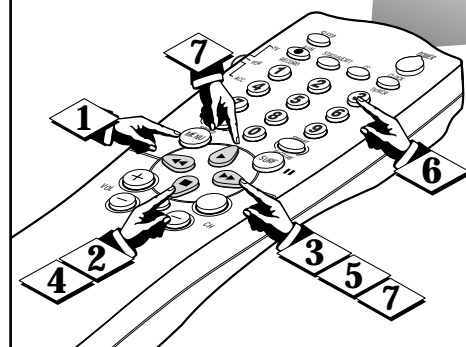
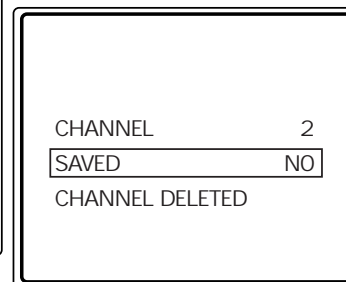
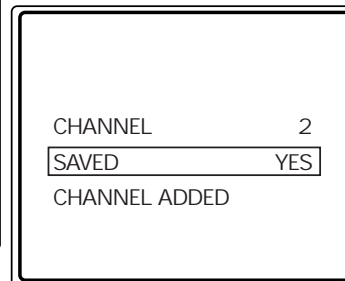
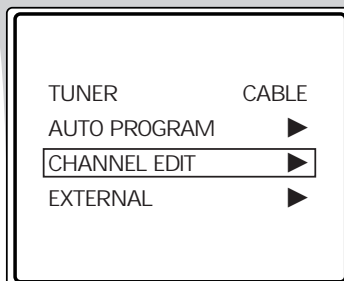
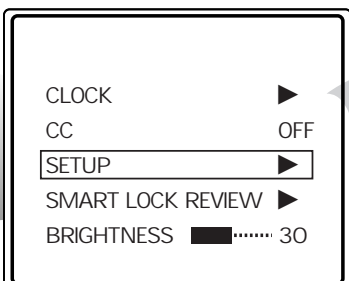

## EXTERNAL

BEGIN

The External feature allows you to rename your input source selections. When the Input feature (refer to Owner's Manual for details) is accessed to change audio/video jacks, your source selection will be called by the name you choose. This name will also appear onscreen when using the audio/video inputs.

1 Press the MENU button on the remote to show the onscreen menu.

2 Press the CURSOR UP or DOWN buttons to scroll through the onscreen menu until the word SETUP is highlighted.

3 Press the CURSOR RIGHT button to display the SETUP menu features.

4 Press the CURSOR UP or DOWN buttons to scroll the Setup features until the word EXTERNAL is highlighted.

5 Press the CURSOR RIGHT button to activate the External feature.

6 With the External options menu displayed, press the CURSOR RIGHT button to select a name from the list: EXT, GAM, DVD, VCD, VCR, LD, or SAT.

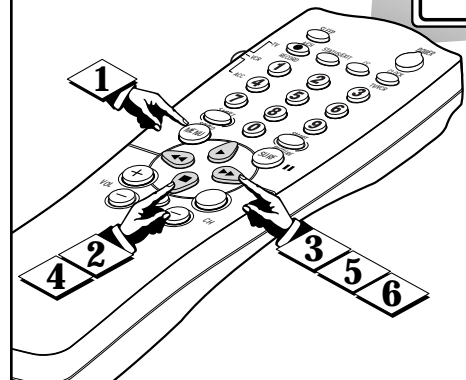
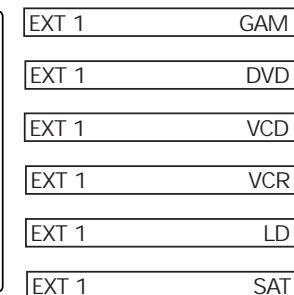
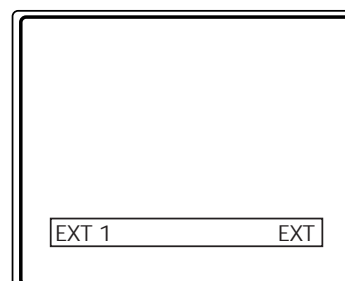
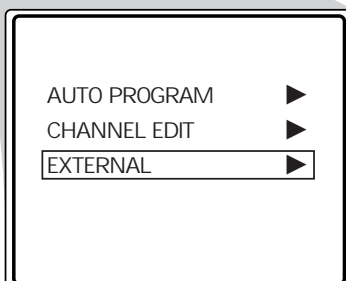
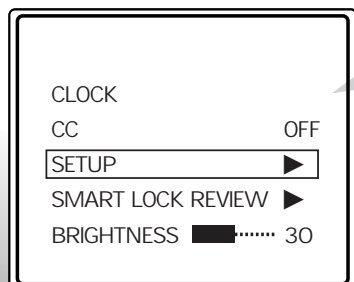

### SMART HELP

Remember: This feature will rename your external signal source and appear onscreen with the new name.

The onscreen menu will time out and disappear from the screen when you finish, or you can press the STATUS/EXIT button to clear the menu from the screen.