

# PHILIPS MAGNAVOX

## OWNER'S MANUAL (USE AND SET-UP GUIDE)



### TABLE OF CONTENTS

#### Getting Started

Warning/Precautions .....	1, 8
Hooking Up Your TV .....	2
VCR to TV Antenna Connections .....	2
Basic TV and Remote Control Operation .....	3
How to Use the First Time Set-Up .....	3

#### On-Screen Features

◇ Setting the TV for Cable TV Operation .....	4
◇ Adding Channels in Memory (Manually) .....	4
◇ Using the TV Volume Bar Control .....	5
◇ Using the TV Volume Limiter .....	5
◇ Setting the TV Sleep Timer Control .....	5
◇ How to Set the TV for Closed Captioning .....	6
◇ Using the TV Picture and Color Controls .....	7

#### General Information

Glossary of TV Terms .....	7
Tips if Something Isn't Working .....	8
Index .....	8
Warranty .....	8

**NOTE:** This owner's manual is used with several different television models. Not all features (and drawings) discussed in this manual will necessarily match those found with your television set. This is normal and does not require you contacting your dealer or requesting service.

#### For Customer Use

Enter (below) the Serial Number and the Model Number of this television (located on the rear of the TV cabinet).

Retain this information for future reference.

Model No. \_\_\_\_\_

Serial No. \_\_\_\_\_

### FEATURES

- **First Time Set Up** which automatically sets the TV for local channels and the correct picture signal (antenna or cable).
- **Infrared Remote Control** which works your TV as well as all on-screen feature controls.
- **Standard Broadcast (VHF/UHF) or Cable TV (CATV)** channel capability.
- **Closed Captioning** which allows the viewer to read TV program dialogue or voice conversations as on-screen text.
- **Automatic Programming of Channels** for quick and easy selection of favorite stations available in your area.
- **Sleep-Timer** which automatically turns the TV OFF at preset times.
- **Language** control allows the user to select from three options; English, Spanish or French. This controls the On-Screen Menu text only. (Does not work for Closed Captioning.)

Return your Warranty Registration card today to ensure you receive all the benefits you're entitled to.

Once your PHILIPS MAGNAVOX purchase is registered, you're eligible to receive all the privileges of owning a PHILIPS MAGNAVOX product. So complete and return the Warranty Registration Card enclosed with your purchase at once. And take advantage of these important benefits.

#### Warranty Verification

Registering your product within 10 days confirms your right to maximum protection under the terms and conditions of your PHILIPS MAGNAVOX warranty.

#### Owner Confirmation

Your completed Warranty Registration Card serves as verification of ownership in the event of product theft or loss.

#### Model Registration

Returning your Warranty Registration Card right away guarantees you'll receive all the information and special offers which you qualify for as the owner of your model.

Congratulations on your purchase, and welcome to the "family!"

**PHILIPS MAGNAVOX**



Dear PHILIPS MAGNAVOX product owner:

Thank you for your confidence in PHILIPS MAGNAVOX. You've selected one of the best-built, best-backed products available today. And we'll do everything in our power to keep you happy with your purchase for many years to come.

As a member of the PHILIPS MAGNAVOX "family," you're entitled to protection by one of the most comprehensive warranties and outstanding service networks in the industry.

What's more, your purchase guarantees you'll receive all the information and special offers for which you qualify, plus easy access to accessories from our convenient home shopping network.

And most importantly you can count on our uncompromising commitment to your total satisfaction.

All of this is our way of saying welcome—and thanks for investing in a PHILIPS MAGNAVOX product.

Sincerely,

Robert Minkhorst  
President and Chief Executive Officer

P.S. Remember, to get the most from your PHILIPS MAGNAVOX product, you must return your Warranty Registration Card within 10 days. So please mail it to us right now!

Know these  
**safety symbols**



⚡ This "bolt of lightning" indicates uninsulated material within your unit may cause an electrical shock. For the safety of everyone in your household, please do not remove product covering.

⚠ The "exclamation point" calls attention to features for which you should read the enclosed literature closely to prevent operating and maintenance problems.

WARNING: TO PREVENT FIRE OR SHOCK HAZARD, DO NOT EXPOSE THIS EQUIPMENT TO RAIN OR MOISTURE.

CAUTION: To prevent electric shock, match wide blade of plug to wide slot, and fully insert.

ATTENTION: Pour éviter les chocs électriques, introduire la lame la plus large de la fiche dans la borne correspondante de la prise et pousser jusqu'au fond.

**PHILIPS MAGNAVOX** Visit our World Wide Web Site at <http://www.philipsmagnavox.com>

# HOOKING UP YOUR TV (ANTENNA/CABLE TV CONNECTIONS)

## CABLE TV

### CABLE INPUT/CONVERTER

Your Cable TV input into your home may be a single (75 ohm) cable, or a Converter Box installation. In either case the connection to the TV is very easy. Just put the threaded end of the cable signal to the TV's antenna plug and screw it down tight.

**BEGIN**

**1** If your Cable TV signal is a single round cable (75 ohm) then you're ready to connect to the TV.  
**If you have a Cable TV Converter Box:** Connect the Cable TV signal to the Cable Signal IN(put) plug on the Converter.

**2** Connect the Cable TV cable to the ANTENNA/CABLE plug on the TV.  
**If you have a Cable TV Converter Box:** Connect the OUT(put) plug from the Converter to the ANTENNA/CABLE plug on the TV.

NOTE: The connecting cable for the Converter is supplied from the Cable TV Company.

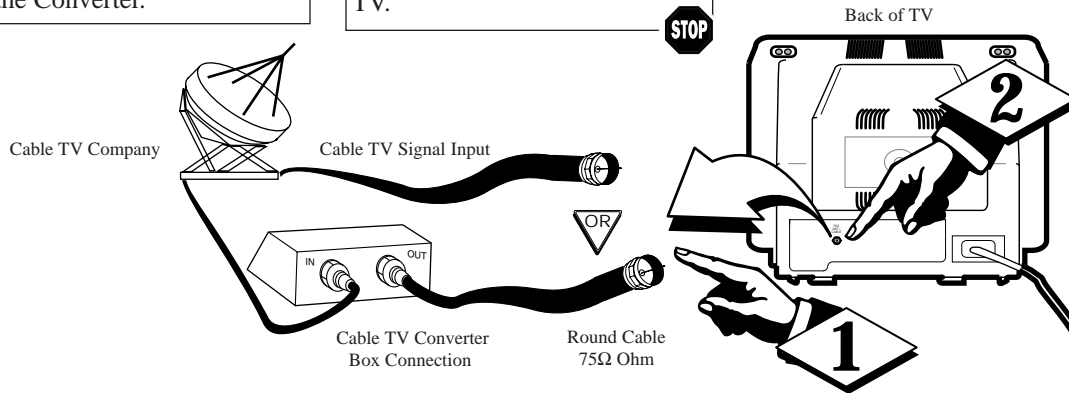

## SMART HELP

Remember, set the TV for the type signal you've just connected (see page 3 of this Set-Up Guide.)

To select only the channel numbers on your Cable system see "Auto Program" (page 3). If you use a Cable Converter box, set the TV to the same channel as the converter's CH 3/4 switch (on the rear of the converter.)

## ANTENNA

### COMBINATION UHF/VHF

A combination antenna receives normal broadcast channels (VHF 2-13 and UHF 14-69). Your connection is easy since there is only one 75Ω (ohm) antenna plug on the back of your TV - and that's where the antenna goes.

**BEGIN**

**1** If your antenna has a round cable (75 ohm) on the end, then you're ready to connect it to the TV.  
**If your antenna has flat twin-lead wire (300 ohm),** you first need to attach the antenna wires to the screws on a 300 to 75 ohm adapter.

**2** Push the round end of the adapter (or antenna) onto the ANTENNA/CABLE plug on the rear of the TV. If the round end of the antenna wire is threaded, screw it down tight.

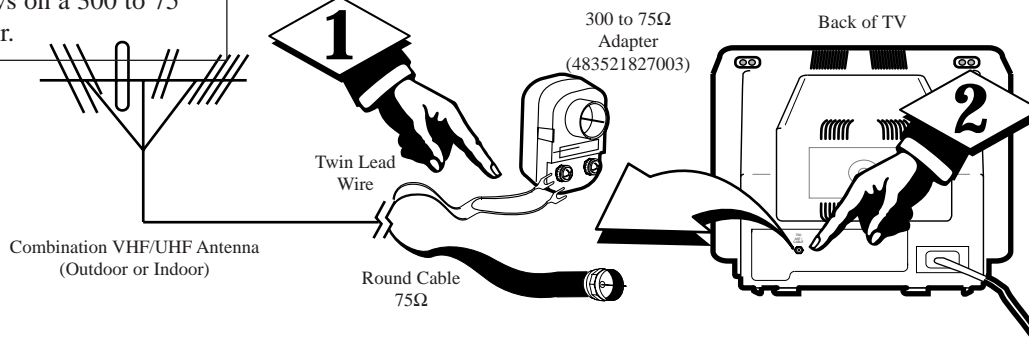

## SMART HELP

Remember, be sure to set the TV for the type signal you've connected (see page 3 of this Set-Up Guide.)

To set the TV to select only the channel numbers in your area see how to "Program" or "Add" channels in memory on page 3.

To order any optional accessory contact your dealer or call the toll-free accessory ordering number (1-800-292-6066):

- UHF/VHF Combiner: (SBV1133A01)
- 75-300 Ohm Adapter: (SBV1113A01)
- 300-75 Ohm Adapter: (483521827003)

### SEPARATE UHF/VHF

Some of you may have two separate antennas. One antenna is for VHF channels (2-13) and the other antenna is for UHF channels (14-69).

For homes with separate UHF/VHF antennas, you will need an optional "combiner" before you can connect to the TV. See the "Smart Help" section (to the right on this page) for ordering details.

**BEGIN**

**1** Attach the separate UHF and VHF antennas to the correct screws on the combiner.

**2** Push the round end of the combiner onto the ANTENNA/CABLE plug on the rear of the TV.

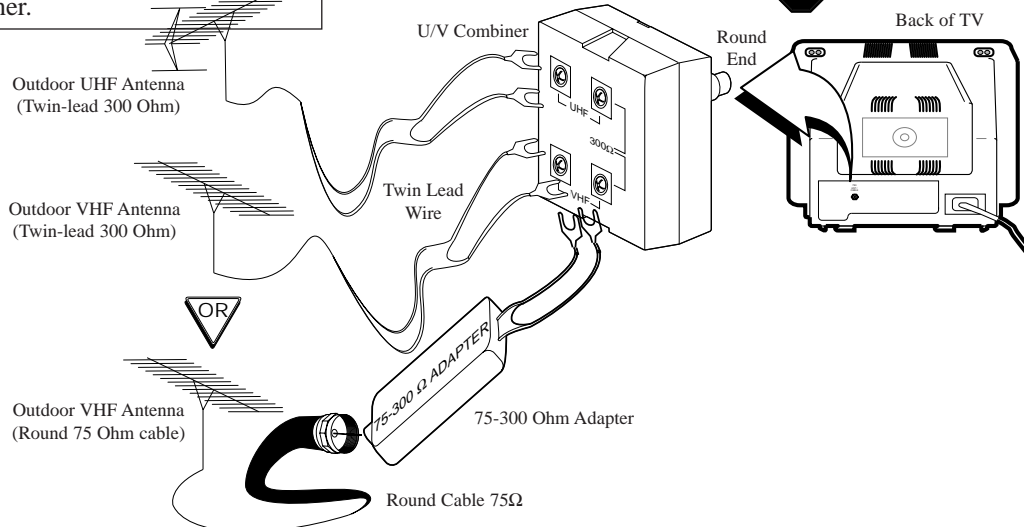

## VCR TO TV

### BASIC CONNECTION

The basic Antenna, or Cable TV, to VCR to TV connection is shown to the right. For more information on other hookups (possible when Cable Converter/Descrambler boxes are included) refer to your accessory VCR and Cable Converter Owner's Manual for details.

**BEGIN**

**1** Connect your Antenna or Cable TV signal to the IN FROM ANT(enna) plug on the VCR.

**2** Connect the OUT TO TV plug on the VCR to the ANTENNA plug on the TV (connecting cable supplied with the VCR.)

**3** Refer to the Owner's Manual included with your VCR for other possible connections and TV/VCR operating details.

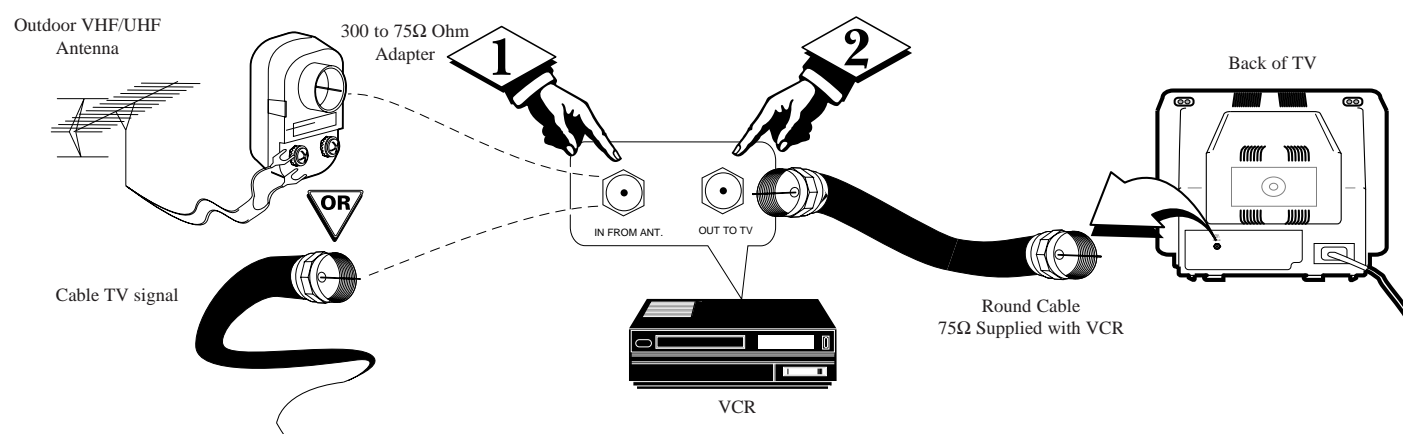

# HOW TO USE AND SETUP OUR TV FOR THE FIRST TIME

## TELEVISION

**BEGIN**

**1** Press the **POWER** button to turn the TV ON.

**2** Press the **VOLUME UP** (▲) or **DOWN** (▼) button to adjust the sound level.

**3** Press the **CHANNEL UP** (▲) or **DOWN** (▼) button to select TV channels.

**4** Press the **MENU UP** (▲) or **DOWN** (▼) button to display the TV's on-screen menu. Then press the MENU UP (▲) or DOWN (▼) button to scroll through the list of on-screen features.

**STOP**

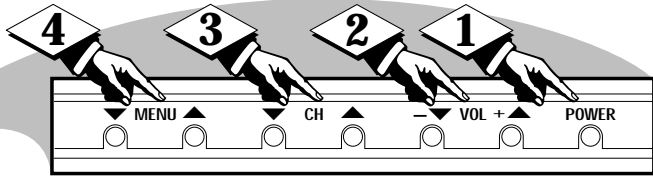
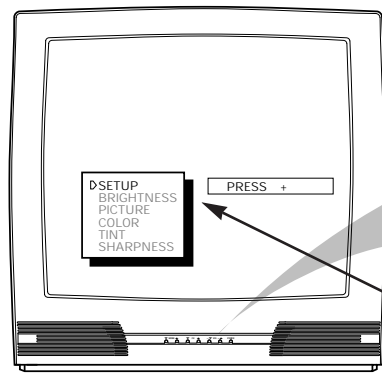

The SETUP on-screen control is automatically selected when you first plug in your TV and press the MENU button (on the TV or remote.)

## SMART HELP

Remember, you can press any button on the front of the TV to turn the TV ON. The tuned channel number will always briefly appear when the TV is first turned ON (and with channel changes.) You can also press the STATUS button (on the remote) to see what channel the TV is ON.



## SETUP MENU

**BEGIN**

**1** Press **MENU (M)** button on the remote (or MENU ▲ or ▼ buttons on the TV). An on-screen list of features appears on the TV screen.

**2** Press the **CH (+) or (-)** buttons on the remote (or the MENU ▲ or ▼ buttons on the TV) to select the **SETUP** feature with the on-screen arrow.

**3** Press the **VOL (+) button** to access the **SETUP** on-screen menu. Then, press the **CH (+) or (-)** buttons to scroll the **SETUP** options. Next press the **VOL (+) or (-)** buttons as directed to use the selected menu items.

**4** Press the **STATUS/EXIT** button on the remote to clear the screen after an adjustment, or scroll to the "EXIT" option in the SETUP screen and press the VOL (+) button to bring you back to the main on-screen menu.

You can also just wait and after a minute the MENU will drop automatically from the screen.

**STOP**

**AUTOMATIC SETTINGS**  
**First Time Setup** takes care of some basic TV control settings for you. Follow the steps in this section to quickly add area channel numbers into the TV's memory, set the Language, and the TV for Antenna or Cable signal.

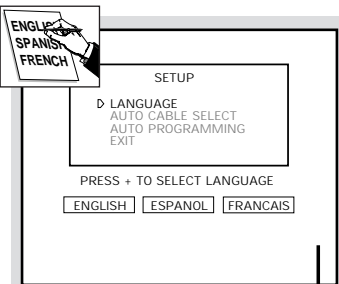

### LANGUAGE

With the Language feature selected, press the VOL (+) button to choose English, Espanol (Spanish), or Francais (French) for the TV's on-screen menu controls.

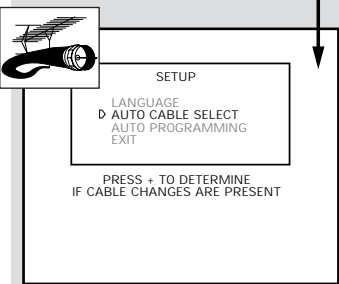

### AUTO CABLE SELECT

With Auto Cable Select chosen, press the VOL (+) button to automatically determine if cable channels are present.

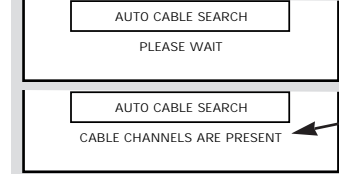

TV set to receive Cable TV supplied channels.

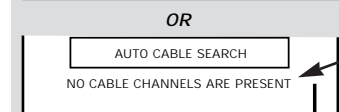

TV set to receive Antenna supplied channels

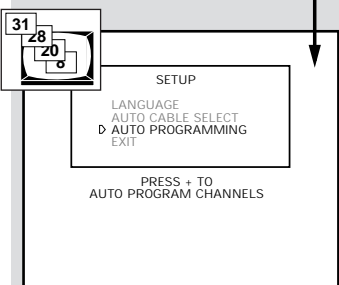

### AUTO PROGRAMMING

With the Auto Programming feature selected, press the VOL (+) button to automatically store all available channels into the TV's memory.

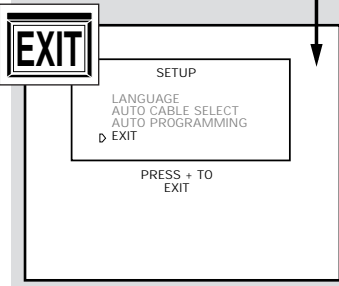
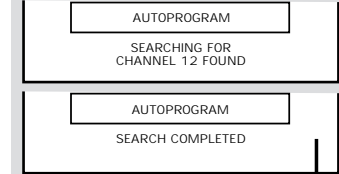

### EXIT

Pressing the VOL (+) button with the Exit feature selected will return you to the main on-screen menu.

## REMOTE

**BEGIN**

**1** Point the remote control toward the remote sensor window on the TV when operating the TV with the remote.

**STOP**

To load the supplied batteries into the remote:

1. Remove the battery compartment lid on the back of the remote.
2. Place the batteries (2-AAA) in the remote. Be sure the (+) and (-) ends of the batteries line up correctly (inside of case is marked.)
3. Reattach the battery lid.

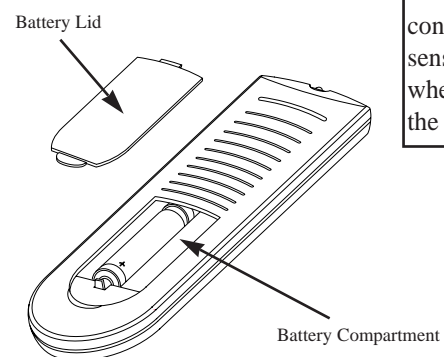

### Channel Scan Button

Press to scan up or down through channel numbers. (Also can be used with the MENU button to select on-screen controls. With the Menu displayed, press Channel ▲ or ▼ buttons to move up or down the list of controls.)

### Status/Exit Button

Press to see the current channel number on the TV screen. Also press this button to clear the TV screen after control adjustments.

### Menu Buttons

Press the M button to show on-screen controls. Press Channel (+) or (-) buttons to move through the list of controls. Press the Volume (+) or (-) buttons to adjust the MENU controls.

### Mute Button

Press to turn the sound OFF on the TV. Press again to return the sound to its previous level.

### CC Button

Press to select the Closed Captioning mode. (CC w MUTE, CAPTION 1, CAPTION 2, or OFF)

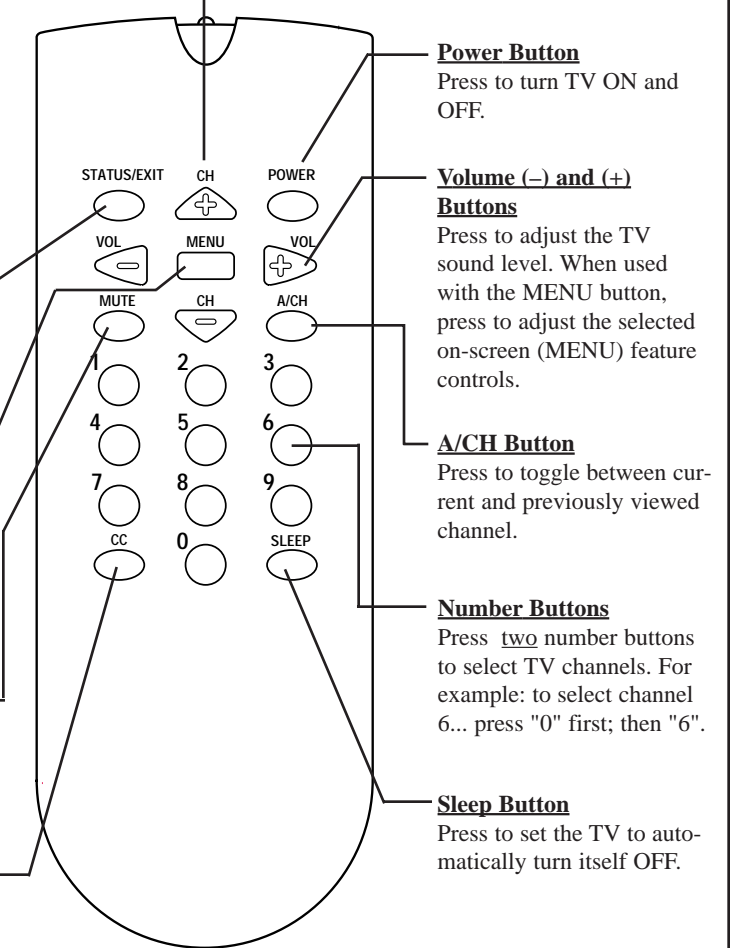

**Power Button**  
Press to turn TV ON and OFF.

**Volume (-) and (+) Buttons**  
Press to adjust the TV sound level. When used with the MENU button, press to adjust the selected on-screen (MENU) feature controls.

**A/CH Button**  
Press to toggle between current and previously viewed channel.

**Number Buttons**  
Press two number buttons to select TV channels. For example: to select channel 6... press "0" first; then "6".

**Sleep Button**  
Press to set the TV to automatically turn itself OFF.

# ON-SCREEN MENU CONTROLS (CONTINUED)

## CABLE

### CABLE OR ANTENNA INPUT

**NOTE:** If you went through First Time Setup (page 3), this task has already been completed for you.

You need to make sure that the TV is set to pick up either Cable TV stations or Antenna signals. In other words, the TV needs to know whether you have connected a Cable TV signal or a normal antenna to its ANTENNA plug (see page 2).

#### BEGIN

**1** Press the **MENU (M)** button on the remote, then the **CH (+)** or **(-)** buttons (or press the **MENU ▲** or **▼** on the TV) to select the word **CABLE** with the TV's on-screen Arrow.

**2** Press the **VOL (+)** or **(-)** buttons (on the TV or the remote) to select either:

**YES-** If you **DO** have Cable TV connected to the TV. Channels 1-125 can be selected.

**NO-** If you have an Antenna connected to the TV. Channels 2-69 can be selected.

**3** Press **STATUS** button on the remote control to clear the screen.

**STOP**

## SMART HELP



Try it out. Press the **CHANNEL (+)** or **(-)** buttons and scan the channels. **CH (+)**, **(-)** works only after **STATUS** button is pressed to clear the screen (or Menu times out - about 1 minute.)

Remember, to set the TV to select the channels on your Cable system, or in your area, see the "Auto Programming" steps in the **SETUP** section on page 3, and "Adding Channels" in the section below.

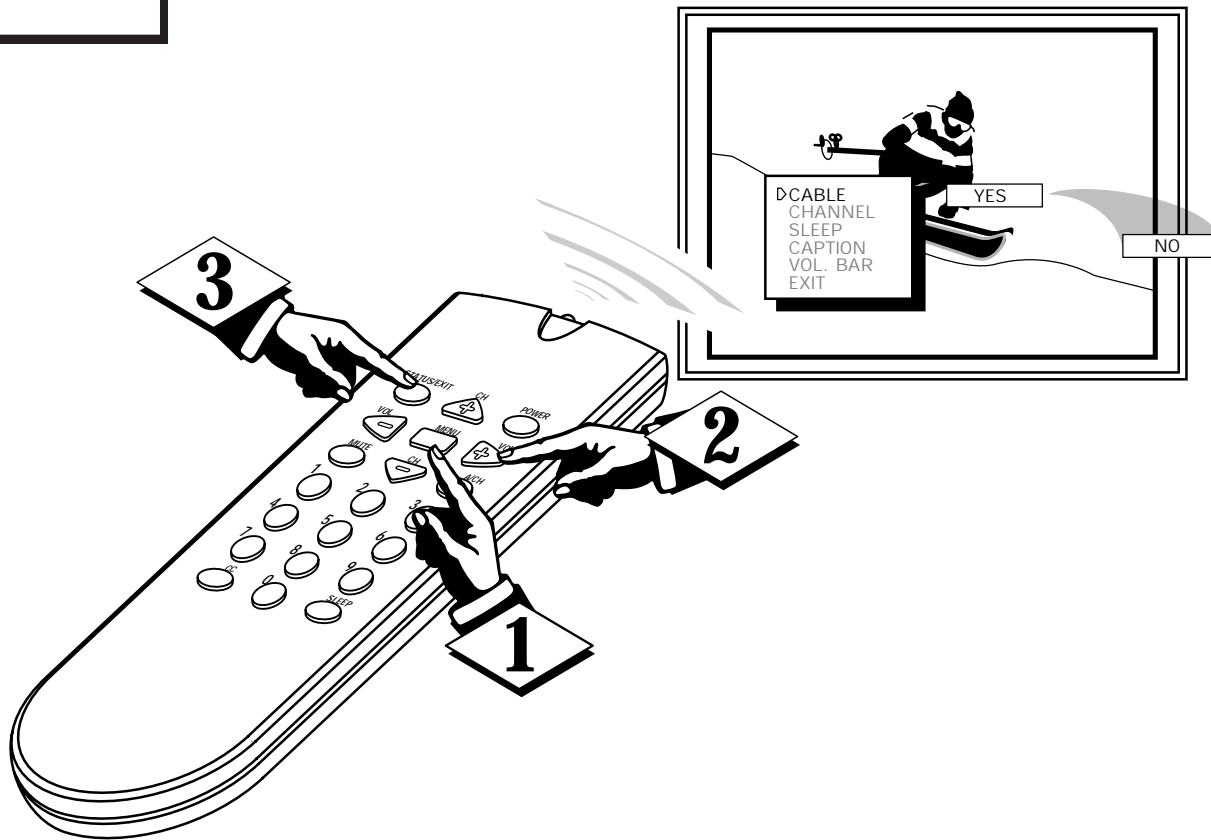

## CHANNEL

### ADD/DELETE CHANNELS

**Auto Programming** (see page 3) adds all the channels it can find (on your Antenna or Cable TV system) into the TV's memory.

**Save/Delete channels** makes it easy for you to add other channels, or drop unwanted channels, from the list of channels in the TV's memory.

#### BEGIN

**1** Press the **MENU (M)** button on the remote, then the **CH (+)** or **(-)** buttons (or the **MENU ▲** or **▼** on the TV) to select the word **CHANNEL** with the TV's on-screen Arrow.

**2** Press **Channel Number** buttons on the remote (or **CH ▲** or **▼** buttons on the TV) to select the channel you want to **SAVE** (or **DELETE**.)

**3** Press the **VOL (+)** button to **SAVE** the selected channel number into memory.

Press **VOL (-)** button to **DELETE** a channel from memory.

**4** Press the **STATUS** button to clear the screen after adding (or deleting) all the channels you want.

**STOP**

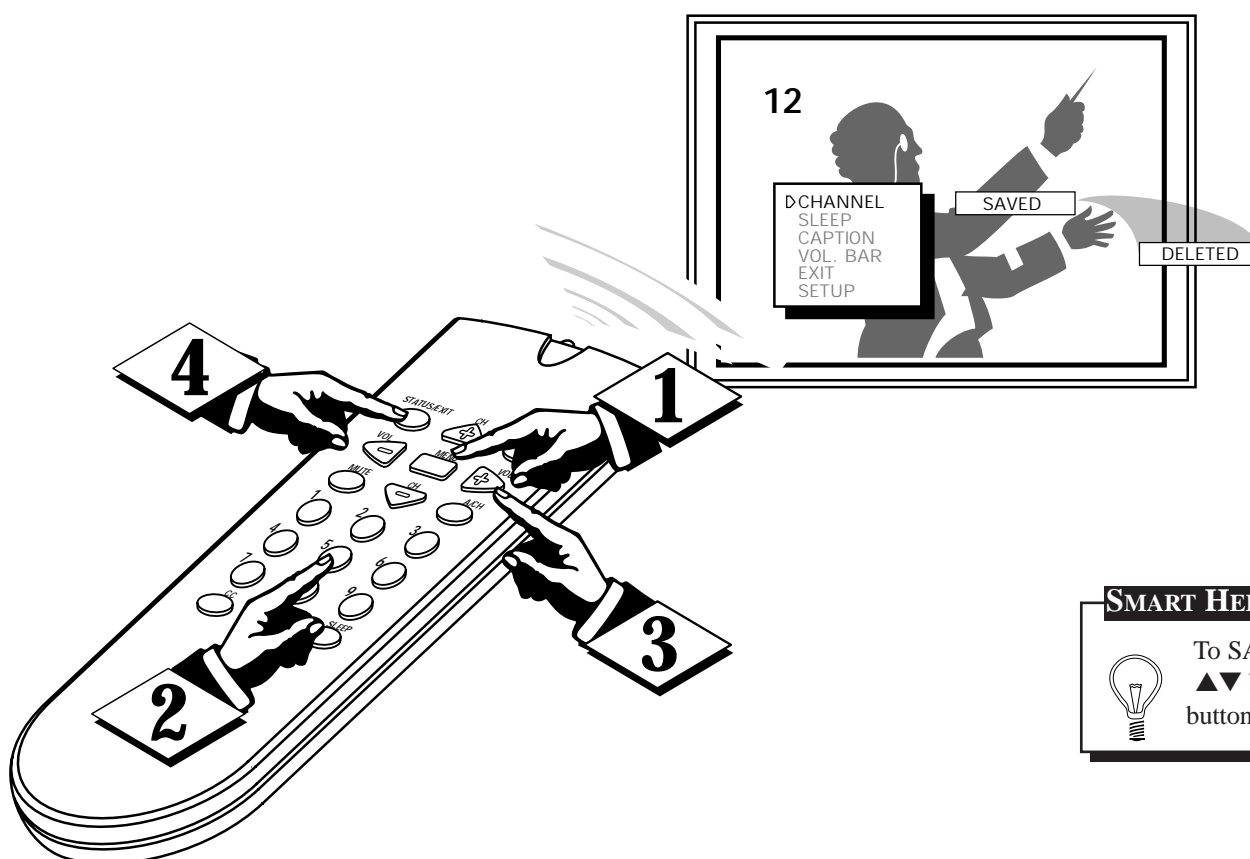

## SMART HELP



To **SAVE** a channel above 100, use the **CH ▲▼** buttons on the TV. The remote number buttons only go up to channel 99.

# ON-SCREEN MENU CONTROLS (CONTINUED)

## VOLUME

### VOLUME BAR

Use the Volume Bar control to see the TV's volume level settings on the TV screen. Once set the Volume Bar will be seen each time the VOLUME buttons (on the TV or remote) are pressed.

**BEGIN**

**1** Press the MENU (M) button on the remote, then press the CH (+) or (-) (or press the MENU ▲ or ▼ buttons on the TV) to select the word VOL. BAR with the TV's on-screen Arrow.

**2** Press the VOL (+) or (-) buttons to turn the VOL BAR control ON or OFF.

**3** Press STATUS button to clear the screen. **STOP**

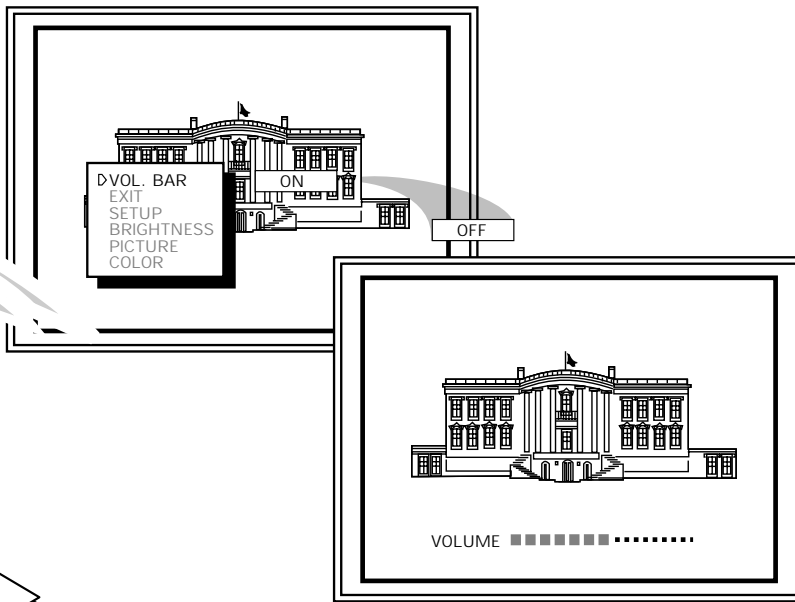
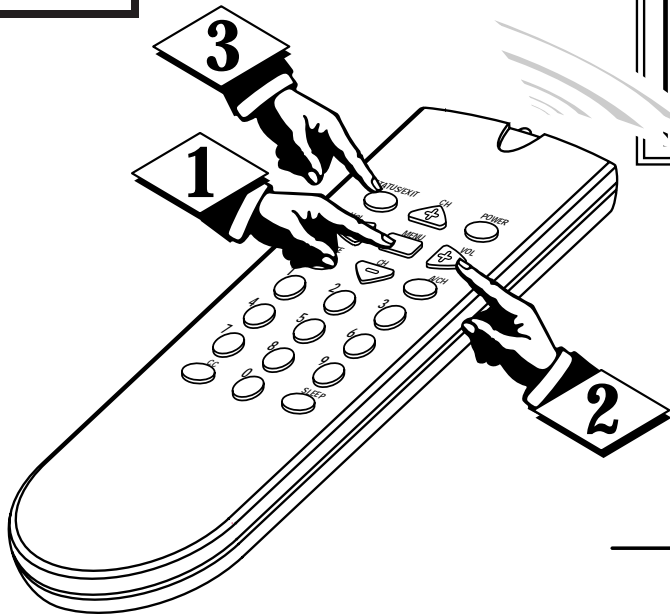

### SMART HELP

Try it out. Press the VOL (+) or (-) buttons. The VOLUME BAR should appear at the bottom of the screen.

NOTE: The TV's volume level can also be lowered when the set is turned OFF.

### LIMITING THE VOLUME

You can limit the maximum volume level of the TV set. Once the Volume Limiter control is set the TV sound cannot be played louder than the maximum preset level.

**BEGIN**

**1** Press numbers 0, 7, 2, 0, 9, 1; then press MENU (M) button on the remote or TV. The VOL. LIMIT bar will show on the TV screen.

**2** Press the VOLUME (+) or (-) button until the VOL. LIMIT bar is at the highest possible volume.

**3** Press the STATUS button to set the maximum volume level. The screen will clear and the TV will return to normal channel viewing. **STOP**

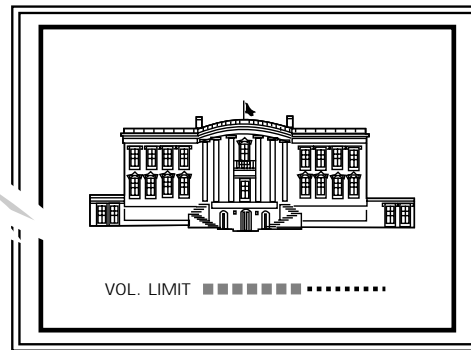
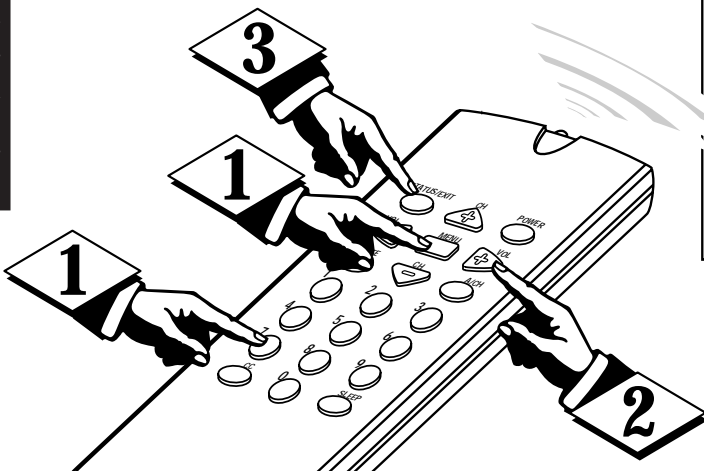

### SMART HELP

Remember, the VOLUME LIMIT Bar will appear to return to the low end of the register (when the STATUS button is pressed to set the desired maximum volume level - step # 3). This is normal for setting the Volume Limiter. Your new maximum volume level has been kept in memory.

NOTE: Not all features (and drawings) discussed in this section will necessarily match those found with your television set. This is normal and does not require you contacting your dealer or requesting service.

## SLEEP

### SLEEP TIMER

Have you ever fallen asleep in front of the TV only to have it wake you up at two in the morning with a test pattern screeching in your ears? Well, your TV can save you all that trouble by automatically turning itself off.

**BEGIN**

**1** Press the SLEEP button on the remote. **OR** Press the MENU (M) button on the remote, then press the CH (+) or (-) (or press the MENU ▲ or ▼ buttons on the TV) to select the word SLEEP with the TV's on-screen Arrow.

**2** Press the SLEEP button repeatedly to pick the amount of time (15 minutes to 2 hours ahead) before the TV will turn itself off. The VOL (+) or (-) buttons can also be used to set the amount of time.

**3** Press the STATUS button to clear the screen after you have set the time for the TV to turn off. An on-screen count down will appear during the last minute before the TV shuts itself off. **STOP**

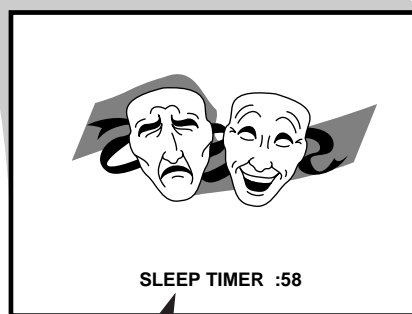
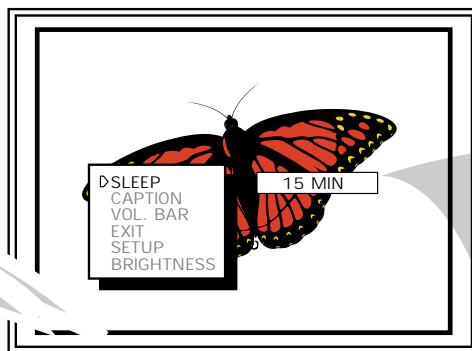
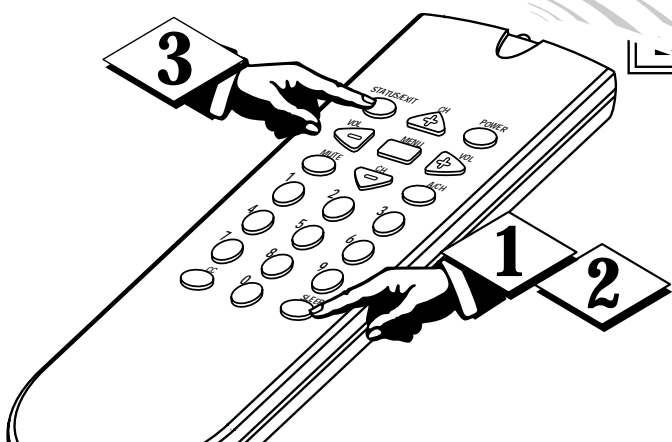

During the last minute of a SLEEP TIMER setting an on-screen count down will be displayed.

### SMART HELP

Remember. If you ever want to see how many minutes are left before the TV shuts itself off, press the STATUS button on the remote.

If you want to stop a SLEEP TIMER setting, reset the timer back to OFF. You could also turn the TV off, and then back on again, to cancel a setting.

Pressing any key on the remote or TV in the last 60 seconds will cancel the SLEEP TIMER setting.

# ON-SCREEN MENU CONTROLS (CONTINUED)

## CAPTION

BEGIN

### CLOSED CAPTIONING

Closed Captioning allows you to read the voice content of television programs on the TV screen. Designed to help the hearing impaired, this feature uses on-screen "text boxes" to show dialogue and conversations while the TV program is in progress.  
 Note: Broadcast stations will often use spelling abbreviations, symbols, dropouts and other grammatical shortcuts in order to keep pace with the on-screen action. These type factors vary upon the source of the captioned text material and do not indicate a need for service on the part of the TV.

**1** Press MENU (M) button on the remote, then press the CH (+) or (-) (or press the MENU ▲ or ▼ buttons on the TV) to select the word **CAPTION** with the TV's on-screen Arrow.

**2** Press VOL (+) or (-) buttons to select the desired Closed Caption (CC) mode - For Example: CAPTION 1.  
 Note: Usually "CAPTION 1" is the most used mode to view captioned material.

**3** Press the STATUS button after making your Caption mode selection. The TV display will clear and Captioning material (if available on the currently selected TV program) will appear on the TV screen.  
 To cancel, set the CAPTION feature to OFF when finished viewing.

STOP

## SMART HELP



Remember, not all TV programs and product commercials are made for broadcast with Closed Caption (CC) information included. Neither are all Closed Caption modes (CAPTION 1 or 2) necessarily being used by a broadcast station during the transmission of a closed caption program. Refer to your area's TV program listings for the stations and times of Closed Caption shows.

**NOTE:** The "CC W/MUTE" setting automatically switches the TV to the Closed Caption 1 mode whenever the MUTE button (on the remote control) is pressed. The Closed Caption 1 mode will turn OFF when the TV sound is returned or unmuted.

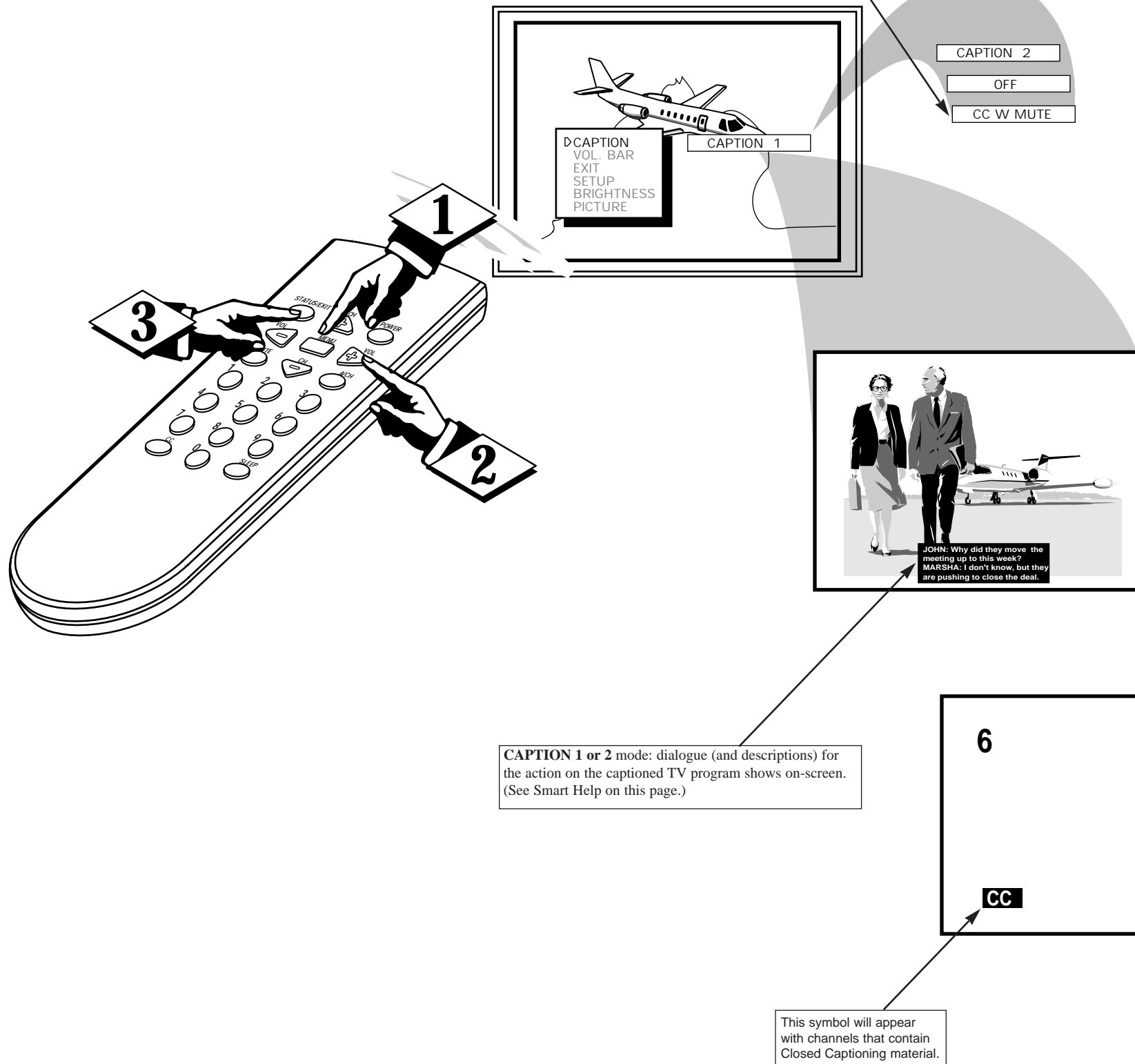

# ON-SCREEN MENU CONTROLS (CONTINUED)

## PICTURE

### PICTURE ADJUSTMENTS

To adjust your TV picture controls, select a channel and follow the steps shown to the right.

#### BEGIN

**1** Press the MENU (M) button on the remote, then press the CH (+) or (-) (or press MENU ▲ or ▼ button-son the TV) until the desired control shows on-screen.

**2** Press the VOL (+) and (-) to adjust the selected picture control.

**3** Press STATUS button (or EXIT Menu) to clear the screen when picture adjustments are completed.

STOP

#### SMART HELP



Remember, with the bar scale centered the control settings are at normal mid-range levels.

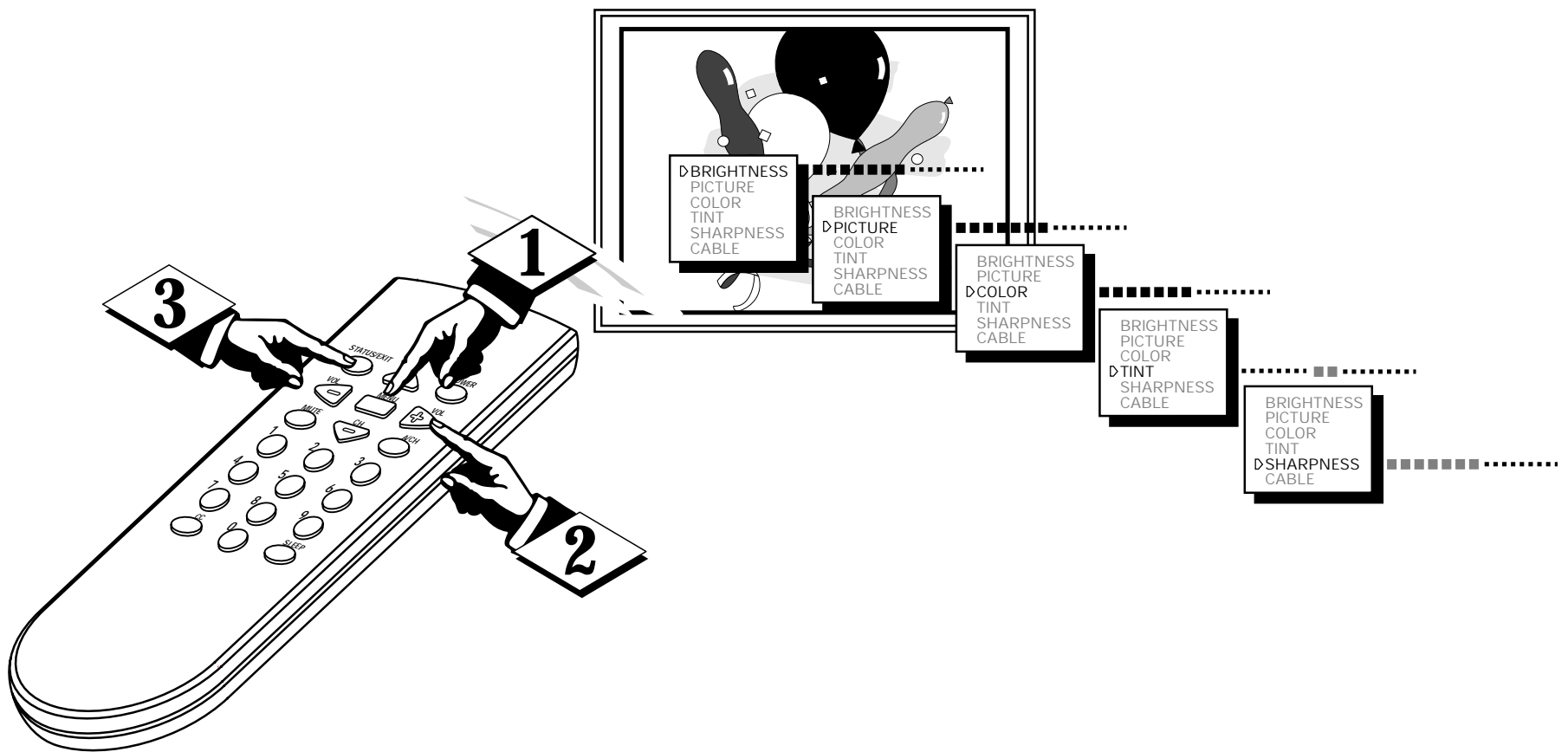

**BRIGHTNESS** Press VOL (-) or (+) until darkest parts of the picture are as bright as you prefer.

**PICTURE** Press VOL (-) or (+) until lightest parts of the picture show good detail.

**COLOR** Press VOL (-) or (+) to add or eliminate color.

**TINT** Press VOL (-) or (+) to obtain natural skin tones.

**SHARPNESS** Press VOL (-) or (+) to improve detail in the picture.

## GLOSSARY

**Round Cable 75Ω** \* A single solid antenna wire normally matched with a metal plug (F-type) end connector that screws (or pushes) directly onto a 75 Ohm input found on the Television or VCR. (Also known as Coaxial Cable.)

**Display** \* An on screen message or graphics that help the user operate and adjust his Television feature controls. See On Screen Displays (OSD).

**Jack Panel** \* Refers to the area on the back of the TV cabinet where the input and output connections are located.

**On Screen Displays (OSD)** \* Refers to the wording or messages generated by the television (or VCR) to help the user with specific feature controls (color adjustment, programming, etc.).

**Menu** \* An on-screen listing of feature controls shown on the Television screen that are made available for user adjustments.

**Programming** \* The procedure of adding or deleting channel numbers into the Television's memory circuits. In this way the Television "remembers" only the locally available or desired channel numbers and skips over any unwanted channel numbers.

**Remote Sensor Window** \* A window or opening found on the Television control panel through which infrared remote control command signals are received.

**Status** \* Allows the user to quickly confirm what channel number is currently being viewed. Status can also be used to clear the Television of on screen displays or information (rather than waiting for the displays to "time out" or automatically disappear from the screen).

**Twin Lead Wire** \* The more commonly used name for the two strand 300 Ohm antenna wire used with many indoor and outdoor antenna systems. In many cases this type of antenna wire requires an additional adapter (or balun) in order to connect to the 75 Ohm Input terminals designed into the more recent Televisions and VCRs.

**Volume Bar** \* When in the ON position, this feature displays an on-screen display of the TV's volume setting.

# GENERAL INFORMATION



## TIPS

BEGIN

### TROUBLESHOOTING

Please make these simple checks before calling for service. These tips can save you time and money since charges for TV installation and adjustment of customer controls are not covered under your warranty.

**CAUTION:** A video source (such as a video game, Compact Disc Interactive - CDI, or TV information channel) which shows a constant non-moving pattern on the TV screen, can cause picture tube damage. When not in use, turn the video source OFF. Regularly alternate the use of such video sources with normal TV viewing.

### 1 No Power

- Check the TV power cord. Unplug the TV, wait 1 minute, then reinsert plug into outlet and push POWER button again.
- Check to be sure outlet is not on a wall switch.
- This TV is equipped with protective circuitry that shuts the TV off in case of moderate power surges. Should this occur turn the TV back on by pressing the POWER button once or twice, or unplug (wait 10 seconds) and then replug the power cord at the AC outlet. This feature is NOT designed to prevent damage due to high power surges such as those caused by lightning, which is not covered by your warranty.

### 2 No Sound

- Check the VOLUME buttons.
- Check the MUTE button on the remote control.

### 3 No Picture

- Check the CABLE/ YES NO control for correct position.
- Check antenna connections on the rear of the TV. Are they properly secured to the antenna plug on the TV?

### 4 Remote Doesn't Work

- Check batteries. Replace with AAA Heavy Duty (Zinc Chloride) or Alkaline batteries if necessary.
- Clean the remote and the remote sensor window on the TV.
- Check the TV power cord. Unplug the TV, wait 1 minute, then reinsert plug into outlet and push POWER button again.

### 5 Wrong Channel (or no Channels above 13)

- Repeat channel selection.
- Add desired channel numbers (CHANNEL control) into TV memory.
- Check CABLE/ YES NO control for correct position.



### Cleaning and Care

- Unplug the TV before cleaning.
- Avoid using anything abrasive that could scratch the screen.
- Wipe the TV screen with a clean cloth dampened with water.
- Gently wipe cabinet surfaces with a clean cloth or sponge dampened with cool clear water. Use a clean dry cloth to dry the wiped surfaces.
- Occasionally vacuum the ventilation holes or slots in the cabinet back.
- Never use thinners, insecticide sprays, or other chemicals on or near the cabinet.



## INDEX

Accessories . . . . .2	Channel Memory . . . . .3, 4	First Time Use . . . . .3	Precautions . . . . .1, 8	SETUP . . . . .3
Add Channels . . . . .4	Closed Caption . . . . .6	Glossary . . . . .7	Programming . . . . .3	Sleep Timer . . . . .5
Antenna Connect . . . . .2	Coaxial Cable . . . . .2	Language . . . . .3	Remote Control . . . . .3	Status Button . . . . .3
Autoprogram . . . . .3	Controls/TV . . . . .3	Menu Button . . . . .3	RF Cable . . . . .2	Tips for Service . . . . .8
Batteries . . . . .3	Controls/Remote . . . . .3	Minus(-) Buttons . . . . .3	Safety Notes . . . . .1	VCR Connections . . . . .2
Cable TV Connect . . . . .2	Display . . . . .3	Picture Adjustments . . . . .7	Service . . . . .8	Volume Bar . . . . .5
Cable TV Control . . . . .4	Features . . . . .1	Plus(+) Button . . . . .3	Sensor Remote . . . . .3	Warranty . . . . .8



## WARRANTY

### COLOR TELEVISION

90 Days Free Labor

One Year Free Replacement of Parts (Two Years Free Replacement on Color Picture Tube)

This product can be repaired in-home.

#### WHO IS COVERED?

You must have proof of purchase to receive warranty service. A sales receipt or other document showing that you purchased the product is considered proof of purchase.

#### WHAT IS COVERED?

Warranty coverage begins the day you buy your product. For 90 days thereafter, all parts will be repaired or replaced free, and labor is free. From 90 days to one year from the day of purchase, all parts will be repaired or replaced free, but you pay for all labor charges. From one to two years from the day of purchase, you pay for the replacement or repair of all parts except the picture tube, and for all labor charges. After two years from the day of purchase, you pay for the replacement or repair of all parts, and for all labor charges.

All parts, including repaired and replaced parts, are covered only for the original warranty period. When the warranty on the product expires, the warranty on all replaced and repaired parts also expires.

#### WHAT IS EXCLUDED?

Your warranty does not cover:

- labor charges for installation or setup of the product, adjustment of customer controls on the product, and installation or repair of antenna systems outside of the product.
- product repair and/or part replacement because of misuse, accident, unauthorized repair or other cause not within the control of Philips Consumer Electronics Company.
- reception problems caused by signal conditions or cable or antenna systems outside the unit.
- a product that requires modification or adaptation to enable it to operate in any country other than the country for which it was designed, manufactured, approved and/or authorized, or repair of products damaged by these modifications.
- incidental or consequential damages resulting from the product. (Some states do not allow the exclusion of incidental or consequential damages, so the above exclusion may not apply to you. This includes, but is not limited to, prerecorded material, whether copyrighted or not copyrighted.)
- a product used for commercial or institutional purposes.

#### WHERE IS SERVICE AVAILABLE?

Warranty service is available in all countries where the product is officially distributed by Philips Consumer Electronics Company. In countries where Philips Consumer Electronics Company does not distribute the product, the local Philips service organization will attempt to provide service (although there may be a delay if the appropriate spare parts and technical manual(s) are not readily available).

#### MAKE SURE YOU KEEP...

Please keep your sales receipt or other document showing proof of purchase. Attach it to this owner's manual and keep both nearby. Also keep the original box and packing material in case you need to return your product.

#### BEFORE REQUESTING SERVICE...

Please check your owner's manual before requesting service. Adjustments of the controls discussed there may save you a service call.

#### TO GET WARRANTY SERVICE IN U.S.A., PUERTO RICO OR U.S. VIRGIN ISLANDS...

Contact a Philips factory service center (see enclosed list) or authorized service center to arrange repair.

(In U.S.A., Puerto Rico and U.S. Virgin Islands, all implied warranties, including implied warranties of merchantability and fitness for a particular purpose, are limited in duration to the duration of this express warranty. But, because some states do not allow limitations on how long an implied warranty may last, this limitation may not apply to you.)

#### TO GET WARRANTY SERVICE IN CANADA...

Please contact Philips at:

1-800-661-6162 (French Speaking)  
1-800-363-7278 (English Speaking)

(In Canada, this warranty is given in lieu of all other warranties. No other warranties are expressed or implied, including any implied warranties of merchantability or fitness for a particular purpose. Philips is not liable under any circumstances for any direct, indirect, special, incidental or consequential damages, howsoever incurred, even if notified of the possibility of such damages.)

#### REMEMBER...

Please record the model and serial numbers found on the product below. Also, please fill out and mail your warranty registration card promptly. It will be easier for us to notify you if necessary.

MODEL # \_\_\_\_\_  
SERIAL # \_\_\_\_\_

Philips Service Company, P.O. Box 555, Jefferson City, Tennessee 37760  
(423) 475-8869