

PHILIPS

Headphones

5000 Series

TAPN505



User manual

Register your product and get support at
www.philips.com/support

Contents

1	Important safety instructions	2
	Hearing Safety	2
	General information	2

2	Your Bluetooth in-ear headphones	3
	What's in the box	3
	Other devices	3
	Overview of your Bluetooth wireless headphone	4

3	Get started	5
	Charge the battery	5
	Pair the headphones with your mobile phone	5

4	Use your headphones	6
	Connect the headphones to a Bluetooth device	6
	Connect to ANC(active noise cancelation)	6
	Connect to airline audio systems	7
	Manage your calls and music	7

5	Technical data	8
---	----------------	---

6	Notice	9
	Declaration of conformity	9
	Disposal of your old product and battery	9
	Remove the integrated battery	9
	Compliance with EMF	9
	Environmental information	10
	Notice of compliance	10

7	Trademarks	11
---	------------	----

8	Frequently asked questions	12
---	----------------------------	----

1 Important safety instructions

Hearing Safety



Danger

- To avoid hearing damage, limit the time you use headphones at high volume and set the volume to a safe level. The louder the volume, the shorter the safe listening time is.

Be sure to observe the following guidelines when using your headphone.

- Listen at reasonable volumes for reasonable periods of time.
- Be careful not to adjust the volume continuously upwards as your hearing adapts.
- Do not turn up the volume so high that you can't hear what's around you.
- You should use caution or temporarily discontinue use in potentially hazardous situations.
- Excessive sound pressure from earphones and headphones can cause hearing loss.
- Using headphones with both ears covered while driving is not recommended and may be illegal in some areas while driving.
- For your safety, avoid distractions from music or phone calls while in traffic or other potentially dangerous environments.

General information

To avoid damage or malfunction:

Caution

- Do not expose headphones to excessive heat
- Do not drop your headphones.
- Headphones shall not be exposed to dripping or splashing.
- Do not allow your headphones to be submerged in water.
- Do not use any cleaning agents containing alcohol, ammonia, benzene, or abrasives.
- If cleaning is required use a soft cloth, if necessary dampened with a minimum amount of water or diluted mild soap, to clean the product.
- The integrated battery shall not be exposed to excessive heat such as sunshine, fire or the like.
- Danger of explosion if battery is incorrectly replaced. Replace only with the same or equivalent type.

About operating and storage temperatures and humidity

- Store in a place where temperature is between -20°C (-4°F) and 50°C (122°F) (up to 90% relative humidity).
- Operate in a place where temperature is between -10°C (14°F) and 50°C (122°F) (up to 90% relative humidity).
- Battery life may be shorter in high or low temperature conditions.

2 Your Bluetooth in-ear headphones

Congratulations on your purchase, and welcome to Philips! To fully benefit from the support that Philips offers, register your product at www.philips.com/support. With this Philips in-ear headphones, you can:

- enjoy convenient wireless handsfree calls;
- enjoy and control wireless music;
- switch between calls and music.

What's in the box

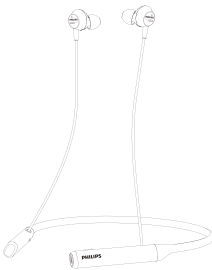

Philips Bluetooth in-ear headphones
Philips TAPN505



Replaceable rubber ear caps x 3 pairs

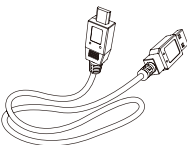

USB charging cable (for charging only)

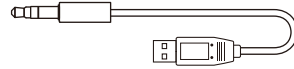

Audio cable with micro USB plug





Quick start guide

Other devices

A mobile phone or device (e.g. notebook, PDA, Bluetooth adapters, MP3 players etc) which supports Bluetooth and is compatible to the headphone (see 'Technical data' on page 8).

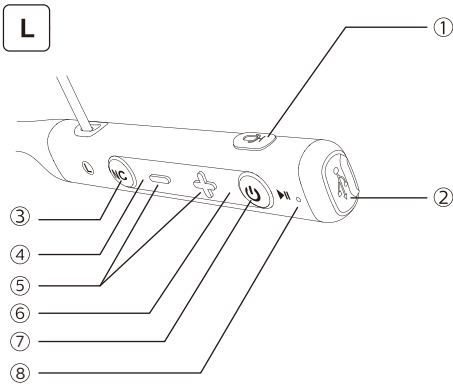
Overview of your Bluetooth wireless headphone



- ① Voice Assistant button
- ② Micro USB charging slot
- ③ ANC On/Off/Ambient sound button
- ④ ANC On/Off/Ambient sound LED indicator
- ⑤ Volume / Track control button
- ⑥ LED indicator
- ⑦  (Power On / Off / Pairing)
- ⑧ Microphone

3 Get started

Charge the battery

Note

- Before you use your headphone for the first time, place the headphones in the charging case and charge the battery for 2 hours for optimum battery capacity and lifetime.
- Use only the original USB charging cable to avoid any damage.
- Finish your call before charging the headphone, as connecting the headphone for charging will power the headphone off.

Charging case

Connect the supplied USB charging cable to:

- The micro USB charging slot on the headphones and;
- The charger/USB port of a computer.

↳ LED turns red during charging and turns off when the headphones in fully charged.

Tip

- Normally, a full charge takes 2 hours.

Pair the headphones with your mobile phone

Before you use the headphones with your mobile phone for the first time, pair it with a mobile phone. A successful pairing establishes a unique encrypted link between the headphones and mobile phone. The headphones store the last 8 devices in the memory. If you try to pair more than 8 devices, the earliest paired device is replaced by the new one.

- 1 Make sure that the headphones are fully charged and turned off.
- 2 Press and hold **⏻** for 5 seconds until the blue and red LED flashes alternately.
↳ The headphone remain in pairing mode for 2 minutes.
- 3 Make sure that the mobile phone is turned on and its Bluetooth feature is activated.
- 4 Pair the headphones with the mobile phone. For detailed information, refer to the user manual of your mobile phone.

The following example shows you how to pair the headphones with your mobile phone.

- 1 Activate the Bluetooth feature of your mobile phone, select **Philips PN505**
- 2 Enter the headphone password "0000" (4 zeros) if prompted. For those mobile phones featuring Bluetooth 3.0 or higher, no need to enter a password.



Philips PN505

4 Use your headphone

Connect the headphone to your Bluetooth device

- 1 Turn on your mobile phone/ Bluetooth device.
- 2 Press and hold the on/off button to turn the headphones on.
 - ↳ The blue LED is on 3s.
 - ↳ The headphones are reconnected to the last connected mobile phone/ Bluetooth device automatically. If the last one is not available, the headphones will be in pairing mode.

Tip

- If you turn on the mobile phone/Bluetooth device or activate the Bluetooth feature after turning on the headphones, you have to reconnect the headphones and mobile phone/Bluetooth device manually.

Note

- If the headphones fail to connect to any Bluetooth device within range in 8 minutes, it will switch off automatically to save the battery life when ANC off or in idle mode.

Connect to ANC (active noise cancelation)

Enable ANC

- Press once ANC button for enable noise cancelation.
- Press once ANC button for disable noise cancelation.

Tip

- When the ANC function is not required, switch off the ANC button to continue your call or listening to music.

Enable Ambient sound mode

- Press once ANC button to enable Ambient sound.
- Press once ANC button disable Ambient sound.
 - ↳ The ANC function will be on/off/ Ambient sound automatically.

Note

- The Ambient sound can be enable only when ANC is also enabled.

ANC LED indicator status

Headphones status	Indicator
ANC is on	The white LED will turn on.
ANC is off	The white LED will turn off.
Ambient sound	The white LED flashes slowly

Wired Connection

You can also use the headphones with the audio cable provided. Make sure the headphones turned on before using the audio cable. Connect the supplied audio cable to the headphones and external audio device.

Tip

- The function keys will be disabled when using line-in mode.

Connect to airline audio systems

- 1 Connect the audio cable into the plane adapter.

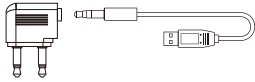

- 2 Insert the adapter into the dual output jacks in the airplane seat.

- 3 Connect the audio cable into the headphone.

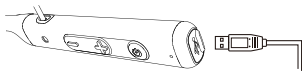

Note

- Need to turn on headphone when connect to airline audio systems.

Manage your calls and music

On/off

Task	Button	Operation
Turn the headphones on.	On/off, music/call control	Press and hold for 3 seconds.
Turn the headphones off.	On/off, music/call control	Press and hold for 5 seconds. ↳ The blue LED flashes 1s and fades out.

Music control

Task	Button	Operation
Play or pause music.	On/off, music/call control	Press once.
Adjust volume.	+/-	Press once.
Next track.	+	Long press.
Previous track.	-	Long press.

Call control

Task	Button	Operation
Pick up/hang up a call.	On/off, music/call control	Press once.
Switch caller during a call.	On/off, music/-call control	Press twice.

Other headphones indicator status

Headphones status	Indicator
The headphones are connected to a Bluetooth device, while the headphones in standby mode or while you are listening to music.	The blue LED will turn on.
The headphones are ready for pairing.	The LED flashes blue and red alternately.
The headphones are on but not connected to a Bluetooth device.	The blue & red LED flashes slowly If no connection can be made, the headphones will turn itself off within 8 minutes.
Low battery level.	The red LED flashes until it is out of power
Battery is fully charged.	Red LED is off.

Voice Assistant

Task	Button	Operation
Trigger voice assistant	Voice assistant	Press and hold

5 Technical data

- Music time — ANC enabled with Bluetooth: 9 hours | ANC disabled with Bluetooth: 14 hours
- Talk time — ANC enabled with Bluetooth: 9 hours | ANC disabled with Bluetooth: 14 hours
- Standby time — ANC enabled with Bluetooth: 160 hours | ANC disabled with Bluetooth: 160 hours
- Charging time: 2 hours
- Rechargeable lithium polymer battery (180 mAh)
- Bluetooth version: 5.0
- Compatible Bluetooth profiles:
 - HSP (Hands-Free Profile-HFP)
 - A2DP (Advanced Audio Distribution Profile)
 - AVRCP (Audio Video Remote Control Profile)
- Supported audio codec: SBC
- Frequency range: 2.505–2.480 GHz
- Transmitter power: < 10 dBm
- Operating range: Up to 10 meters (33 feet)
- Digital echo & noise reduction
- Auto power off
- Micro-USB port for charging
- Supports SBC
- Low battery warning: available



Note

- Specifications are subject to change without notice.

6 Notice

Declaration of conformity

Hereby, MMD Hong Kong Holding Limited declares that this product is in compliance with the essential requirements and other relevant provisions of Directive 2014/53/EU. You can find the Declaration of Conformity on www.p4c.philips.com.

Disposal of your old product and battery



Your product is designed and manufactured with high quality materials and components, which can be recycled and reused.



This symbol on a product means that the product is covered by European Directive 2012/19/EU.



This symbol means that the product contains a built-in rechargeable battery covered by European Directive 2013/56/EU which cannot be disposed of with normal household waste. We strongly advise you to take your product to an official collection point or a Philips service centre to have a professional remove the rechargeable battery. Inform yourself about the local separate collection system for electrical and electronic products and rechargeable batteries. Follow local rules and never dispose of the product and rechargeable batteries with normal household waste. Correct disposal of old products and rechargeable batteries helps prevent negative consequences for the environment and human health.

Remove the integrated battery

If there is no collection/recycling system for electronic products in your country, you can protect the environment by removing and recycling the battery before disposing the headphones.

- Make sure the headphone is disconnected from the charging case before removing the battery.

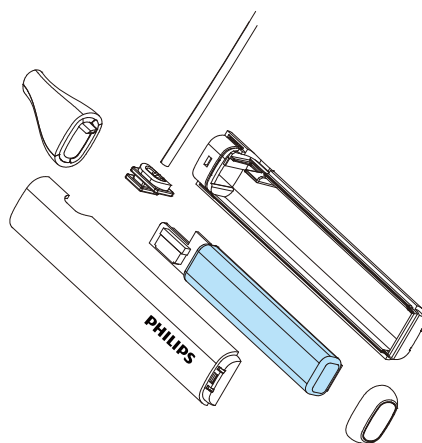

Compliance with EMF

This product complies with all applicable standards and regulations regarding exposure to electromagnetic fields.

Environmental information

All unnecessary packaging has been omitted. We have tried to make the packaging easy to separate into three materials: cardboard (box), polystyrene foam (buffer) and polyethylene (bags, protective foam sheet.)

Your system consists of materials which can be recycled and reused if disassembled by a specialized company. Please observe the local regulations regarding the disposal of packaging materials, exhausted batteries and old equipment.

Notice of compliance

The device complies with the FCC rules, Part 15. Operation is subject to the following two conditions:

1. This device may not cause harmful interference, and
2. This device must accept any interference received, including interference that may cause undesired operation.

FCC rules

This equipment has been tested and found to comply with the limits for a Class B digital device, pursuant to part 15 of the FCC Rules. These limits are designed to provide reasonable protection against harmful interference in a residential installation. This equipment generates, uses and can radiate radio frequency energy and, if not installed and used in accordance with the instruction manual, may cause harmful interference to radio communications. However, there is no guarantee that interference will not occur in a particular installation. If this equipment does cause harmful interference to radio or

television reception, which can be determined by turning the equipment off and on, the user is encouraged to try to correct the interference by one or more of the following measures:

- Reorient or relocate the receiving antenna.
- Increase the separation between equipment and receiver
- Connect the equipment into an outlet on a circuit different from that to which the receiver is connected.
- Consult the dealer or an experienced radio/TV technician for help.

FCC Radiation Exposure Statement:

This equipment complies with FCC radiation exposure limits set forth for an uncontrolled environment.

This transmitter must not be co-located or operating in conjunction with any other antenna or transmitter.

Caution: The user is cautioned that changes or modifications not expressly approved by the party responsible for compliance could void the user's authority to operate the equipment.

Canada:

This device contains licence-exempt transmitter(s)/receiver(s) that comply with Innovation, Science and Economic Development Canada's licence-exempt RSS(s). Operation is subject to the following two conditions: (1) this device may not cause harmful interference, and (2) This device must accept any interference received, including interference that may cause undesired operation of the device.

CAN ICES-3(B)/NMB-3(B)

IC Radiation Exposure Statement:

This equipment complies with Canada radiation exposure limits set forth for uncontrolled environments.

This transmitter must not be co-located or operating in conjunction with any other antenna or transmitter.

7 Trademarks

Bluetooth

The Bluetooth® word mark and logos are registered trademarks owned by Bluetooth SIG, Inc. and any use of such marks by MMD Hong Kong Holding Limited is under license. Other trademarks and trade names are those of their respective owners.

Siri

Siri is a trademark of Apple Inc., registered in the U.S. and other countries.

Google

Google and the Google Logo are registered trademarks of Google Inc.

8 Frequently asked questions

My Bluetooth headphone does not turn on.

The battery level is low. Charge the headphone.

I cannot pair my Bluetooth headphone with my Bluetooth device.

The Bluetooth is disabled. Enable the Bluetooth feature on your Bluetooth device and turn on the Bluetooth device before you turn on the headphone.

The Bluetooth device cannot find the headphone.

- The headphone may be connected to a previously paired device. Turn off the connected device or move it out of range.
- Pairing may have been reset or the headphone has been previously paired with another device. Pair the headphone with the Bluetooth device again as described in the user manual. (see 'Pair the headphone with your Bluetooth device at the first time' on page 6).

My Bluetooth headphone is connected to a Bluetooth stereo enabled mobile phone, but music only plays on the mobile phone speaker.

Refer to the user manual of your mobile phone. Select to listen to music through the headphone.

The audio quality is poor and crackling noise can be heard.

- The Bluetooth device is out of range. Reduce the distance between your headphone and Bluetooth device, or remove obstacles between them.
- Charge your headphone.

The audio quality is poor when streaming from the mobile phone is very slow, or audio streaming does not work at all.

Make sure your mobile phone not only supports (mono) HSP/HFP but also supports A2DP and is BT4.0x (or higher) compatible (see 'Technical data' on page 10).



Philips and the Philips Shield Emblem are registered trademarks of Koninklijke Philips N.V. and are used under license. This product has been manufactured by and is sold under the responsibility of MMD Hong Kong Holding Limited or one of its affiliates, and MMD Hong Kong Holding Limited is the warrantor in relation to this product.

