

Register your product and get support at
www.philips.com/welcome

SPZ3000



EN User manual

PHILIPS

Contents

1 Your webcam	2
Welcome	2
What's in the box	2
Functional overview	3

2 Get started	4
(Optional) Install the webcam software and driver	4
Connect the webcam to your PC/notebook	4

3 Use the webcam for video chatting	6
--	----------

4 Philips CamSuite	7
---------------------------	----------

5 Philips CamSuite Capture	8
Take and view a photo	8
Record and play a video	8
Image resolution	8
Screen mode	9
Gallery	9
Open the photo/video folder	9
Photo/Video menu	9
Send photo(s)/video(s) via email	10
Delete photo(s)/video(s) from the gallery	10

6 Features provided by Webcam Driver SPZ3000	11
Properties	11
General tab	12
Video/Video Pro Amp tab	12
Audio tab	12
Features tab	13

7 Technical specifications	14
-----------------------------------	-----------

8 Frequently asked questions (FAQ)	15
How can I adjust image quality?	15
The microphone of my Philips SPZ3000 webcam or headset does not work (properly).What should I do?	15
Using my Philips SPZ3000 webcam makes my PC/notebook run slow.What should I do?	16
No image is available on the screen.What should I do?	16

9 Service and support	17
Need help?	17
Information to the customer	17
Safety precautions	17
Copyright	18
Disclaimer	18
FCC compliance	18
Compliance with Electro-Magnetic Field (EMF)	19
Recycling	19
Limitations of damages	19

10 Glossary	20
--------------------	-----------

1 Your webcam

Congratulations on your purchase, and welcome to Philips! To fully benefit from the support that Philips offers, register your product at www.philips.com/welcome.

- At www.philips.com/welcome, select your language and choose **Register my product**. Then follow the on-screen instructions for registration.

Please read the following instructions carefully, and retain them for future reference.

Welcome

The Philips SPZ3000 webcam you have just purchased is manufactured to the highest standards and will give you years of trouble-free use. Brilliant images and amazing sound quality, that's what you get with the SPZ3000 webcam.

After installation, the new webcam can be used for all sorts of applications, such as:

- **Video:** Use the Philips SPZ3000 webcam for video chatting and video calling. The webcam works with Skype, Windows® Live Messenger, Yahoo! Messenger, AOL Instant Messenger, QQ and other instant messaging and VoIP (Voice over Internet Protocol) services;
- **Video sharing:** Create your own video clips and share them with friends and family via email, etc.;
- **Snapshot images:** With Philips applications installed, use the snapshot button to easily take photos and share your photos via Facebook, Flickr, MySpace, and etc.;

The following sections in this manual give a step-by-step description on how to use the Philips SPZ3000 webcam.

What's in the box

Please check that the following items are packed in the Philips SPZ3000 webcam box.

- Philips SPZ3000 webcam

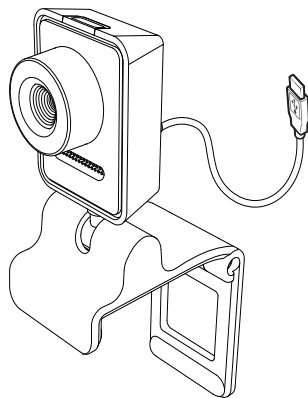

- Quick start guide

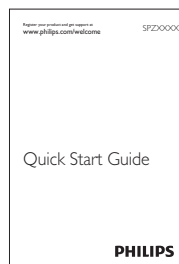

Functional overview

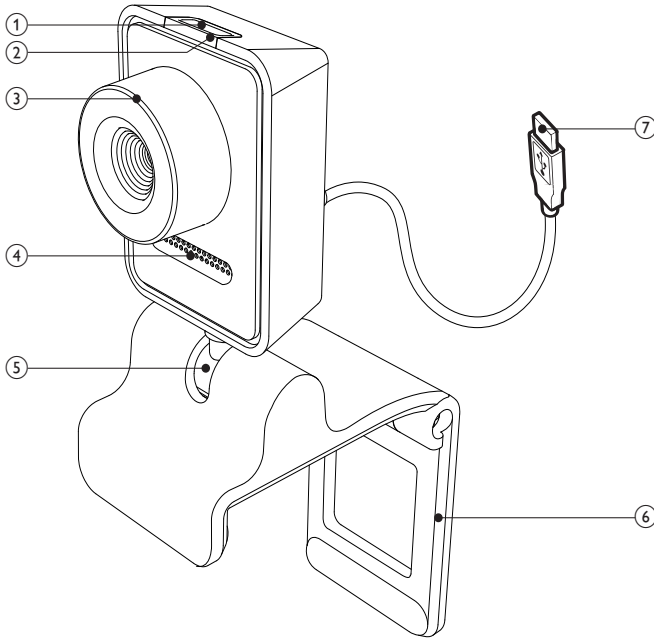

① Snapshot button

- With Philips applications installed, take photos directly

② Power LED

- Lights up when the webcam is in use

③ Focus ring

- Adjust the focus of the image manually

④ Built-in microphone

- Capture voice and sound during video calling and recording

⑤ Rotating joint

- Change the viewing field of the webcam manually

⑥ Clamp with rubber rims

- Mount the webcam on your (flat panel) PC monitor or notebook screen
- Fold the clamp when the webcam is placed on a desk or (large) desktop monitor

⑦ USB connector

- Connect the webcam to the USB port of the notebook or desktop PC
- Supply power to the webcam when it is connected to the notebook or desktop PC

2 Get started

(Optional) Install the webcam software and driver

Note

- To use special features provided by Philips CamSuite and Webcam Driver SPZ3000, visit www.philips.com/support and download the applications from the website. Philips CamSuite only works on PCs with the operating systems Microsoft® Windows® XP (SP2 and higher), Vista, or Windows 7. After the software installation, you can adjust Philips SPZ3000 webcam settings on respective property pages.

- 1 At www.philips.com/support, click the **Choose country / language** box to select your country/language.
- 2 Click the **Search** box, enter **SPZ3000** and then click the search button.
- 3 Click **SPZ3000** under the search results.
- 4 Click **Support**.
 - ↳ Under **Product support**, you will find information about **Software and drivers**.
- 5 Download the software or driver installer that you want.
- 6 Run the installer and follow the instructions on the screen to complete the installation.

Tip

- You can use the same way to download the latest software and driver available for Philips SPZ3000 webcam.

Connect the webcam to your PC/notebook

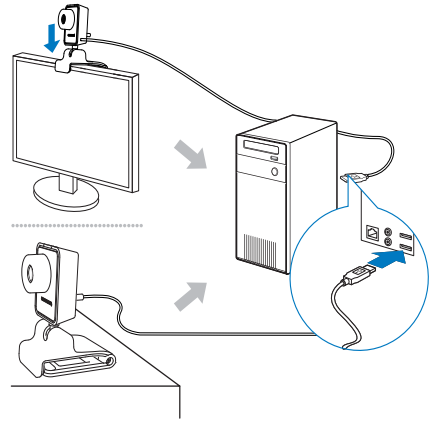

- 1 Turn on the PC/notebook.
- 2 For the first time you use the webcam with Philips CamSuite, install the software downloaded from the website.
 - ↳ After the software installation is complete, the Philips CamSuite icon is displayed at the lower right corner of the screen.
- 3 Use the clamp to mount the webcam on your PC monitor or notebook display.
 - Fold the clamp to place the webcam on a desk or (large) desktop monitor.
- 4 Connect the cable to a USB port on the PC/notebook.
 - ↳ After the webcam is properly connected, the following pop-up window is displayed at the lower right corner of the screen .

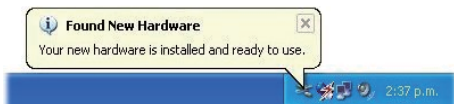

- 5 Aim the webcam in a proper angle.
 - ↳ After you launch Philips CamSuite, you can use the features provided by the application for Philips SPZ3000 webcam.

3 Use the webcam for video chatting

Philips SPZ3000 webcam works with Skype, Windows® Live Messenger, Yahoo! Messenger, AOL Instant Messenger, QQ and other instant messaging and VoIP (Voice over Internet Protocol) services.

After you install one of the above applications, you can plug the webcam into the PC/ notebook and use it for video chatting.

After use, you can fold the camera to store it.

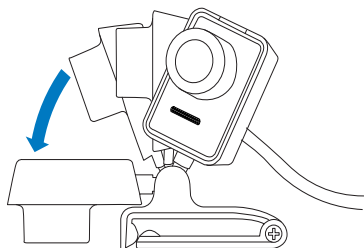

4 Philips CamSuite

Philips CamSuite provides a quick access to a number of the most used features and settings.

To enjoy the special features and settings provided by Philips CamSuite, install it before using it with Philips SPZ3000 webcam.

After you install Philips CamSuite, you can double-click the Philips CamSuite icon  on the Windows toolbar to access the Philips CamSuite control panel.

- If Webcam Driver SPZ3000 is not installed, the following control panel is displayed :





- If you also have Webcam Driver SPZ3000 installed on the PC/notebook, a different interface of the Philips CamSuite control panel is displayed and a different **[Properties]** window is displayed after you click .



5 Philips CamSuite Capture

Via Philips CamSuite Capture, you have access to the following webcam features:

- Take photos
- Record videos
- Send photos or videos by email
- Adjust settings for photo, video, mute, and multimedia folders
- Know the software version of Philips CamSuite

- 1 To launch Philips CamSuite Capture, click  on the Philips CamSuite control panel or double-click  on the desktop.
- 2 To close Philips CamSuite Capture, click the close button at the top right corner of the Philips CamSuite Capture window.



Tip

- If you are already using the webcam in another application, you will not be able to see any image in the viewer of Philips CamSuite Capture.

Take and view a photo



- 1 Aim the camera in a proper angle.
 - 2 In the Philips CamSuite Capture window, click .
 - ↳ A photo is taken and stored in the photo gallery (also in the selected photo folder on the PC/notebook).
- **To view a photo in the photo gallery, double-click it.**

Record and play a video



Note

- If you select any resolution higher than 640 x 480 (VGA), the recording icon is disabled. You can select a lower resolution to enable recording.

- 1 Aim the camera as needed.
 - 2 In the Philips CamSuite Capture window, click  to start recording.
 - To pause recording, click .
 - 3 To stop recording, click .
 - ↳ A video is recorded and stored in the video gallery (also in the selected in the video folder on the PC/notebook).
- **To play a video in the video gallery, double-click it.**



Tip

- Before you play a video, ensure that you have a multimedia player installed on the PC/notebook.

Image resolution

You can set different image resolutions for photos/videos taken via the webcam:

- 160 x 120 (SQVGA)
- 176 x 144 (QCIF)
- 320 x 240 (E-mail size)
- 352 x 288 (CIF)
- 640 x 480 (VGA)
- 1280 x 1024 (1.3 MP, for photo only)
- 2560 x 2048 (for photo only)



Note

- For video recording, the maximum resolution is up to 640 x 480 (VGA).

- 1 In the Philips CamSuite Capture window, click the drop-down arrow.
 - ↳ The provided resolution options are listed.
- 2 Select a preferred resolution option.
 - To apply another resolution setting, repeat Step 1 and Step 2.

Screen mode

Via Philips CamSuite Capture, you can view a photo or play a video in different modes:





- Normal screen mode
 - Full screen mode
 - Fit on screen
- 1 In the Philips CamSuite Capture window, click  to switch between modes, from [Normal screen mode] to [Full screen mode] / [Fit on screen] or from [Full screen mode] / [Fit on screen] to [Normal screen mode].
 - ↳ You can select [Fit on screen] or [Full screen mode] in the drop down list.



Gallery

Photos and videos taken via the webcam are stored in the photo or video gallery and in the selected photo or video folder (multimedia folders).

To access the gallery:

- 1 In Philips CamSuite Capture, click  Gallery to show gallery.
- 2 Click  to show the photo gallery.
 - Click  to show the video gallery.
 - To hide the gallery, click .

Open the photo/video folder

In the photo gallery:

- 1 Select a photo and then click  to open the photo folder.

In the video gallery:

- 1 Select a video and then click  to open the video folder.

Photo/Video menu

To display the photo/video menu via right-click on the mouse:

- 1 In the photo/video gallery, select a photo/video.
- 2 Right-click the mouse.
 - ↳ The photo/video menu is displayed.
- 3 Select an option to continue.

Options on the photo menu:

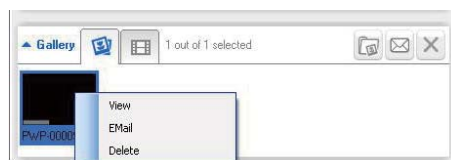

- **[View]:** To view the selected photo(s)
- **[Email]:** To send the selected photo(s) via email
- **[Delete]:** To delete the selected photo(s)

Options on the video menu:



- **[Play]:** To play the selected video(s)
- **[Email]:** To send the selected video(s) via email
- **[Delete]:** To delete the selected video(s)



↳ The selected photo(s)/video(s) are deleted from the gallery.

- To cancel the deletion, click **[No]** in the pop-up window.

Send photo(s)/video(s) via email

- 1 In the photo/video gallery, select photo(s)/video(s) that you want to send via email.
- 2 Click .
↳ An email message is displayed with the selected photo(s)/video(s) attached.
- 3 Send the email.

Delete photo(s)/video(s) from the gallery

- 1 In the photo/video gallery, select photo(s)/video(s) that you want to delete.
- 2 Click  beside .
- 3 In the pop-up window, click **[Yes]**.



6 Features provided by Webcam Driver SPZ3000

If both Webcam Driver SPZ3000 and Philips CamSuite are installed on the PC/notebook, Philips CamSuite provides a quick access to the following features provided by Webcam Driver SPZ3000:



Image settings

- Digital zoom
- Face tracking



Audio settings

- Noise reduction



Webcam settings

- Select an available Philips webcam
- Adjust properties

- 1 Click one of the buttons on the Philips CamSuite control panel to access a settings panel.
- 2 In each settings panel, check the boxes to activate the features.
 - To disable a feature, clear the box.



Tip

- For details of the features, see the "Properties" section.

Properties

- 1 In the Philips CamSuite control panel, click .
- 2 Click the [Webcam settings] button.
 - ↳ The [Properties] window is displayed.
- 3 In the [Properties] window, click one of the tabs to go on with settings adjustment, such as:
 - General
 - Video/ Video Pro Amp
 - Audio
 - Features

General tab

On the **[General]** tab, you can adjust the **[Region]** settings in order to optimize the quality of image & minimize the flickering issue.

During installation, parameter for **[Region]** will be set automatically to the correct region frequency.

When you travel, you may need to change the setting to optimize the image quality.

The region frequency settings for different countries are listed below, such as:

Country (region)	Region frequency
Europe	50 Hz
North America	60 Hz
China	50 Hz
Taiwan	60 Hz
Japan	Region-dependent



Tip

- Please check your local mains output to find the correct region setting.

Video/Video Pro Amp tab

On the **[Video]** or **[Video Pro Amp]** tab, you can now adjust the following settings:

[White Balance]

Most light sources are not 100% pure white but have a certain 'color temperature'. Normally our eyes compensate for lighting conditions with different color temperatures.

If the automatic white balance is selected, the webcam will look for a reference point which represents white. It will then calculate all other colors based on this white point and compensate the other colors accordingly, just like the human eye.

[Brightness]

Brightness enables you to adjust the brightness of the displayed image or video to suit your

own preference. Use the slider to find your preferred setting.

[Contrast]

Contrast enables you to control the ratio between dark and light according to your own preference. Use the slider to find your preferred setting.

[Gamma]

Gamma enables you to brighten dark areas within the displayed image or video and visualize more details without over-exposing already light areas. Use the slider to find your preferred setting.

[Saturation]

Saturation enables you to set the color reproduction from black and white to a full color image or video according to your own preference. Use the slider to find your preferred setting.

Audio tab

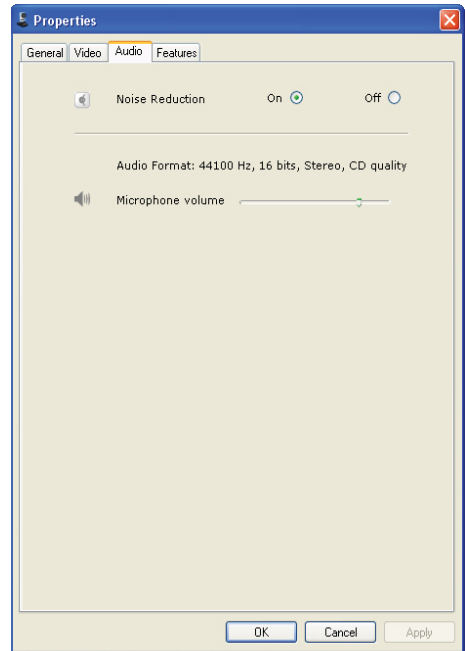

On the **[Audio]** tab, you can now adjust the following settings:

[Noise Reduction]

With this function, you can significantly reduce all stationary noises picked up by the webcam's microphone, such as air conditioner noise and the noise made by the fan inside your computer. It enhances clarity of speech in both quiet and noisy environments.

Volume slider

This slider provides manual control over the microphone.

Features tab

On the **[Features]** tab, you can now adjust the following settings:

[Face tracking]

If you activate the **[Face tracking]** option, the webcam will track your face. This gives you more convenience during video chatting, because you stay in the centre of the image even if you move during video chatting.

[Digital Zoom]

With this function, you can get a closer view of an object.

- 1 Use the slider to dynamically zoom in and out.



Tip

- Digital zoom magnifies the pixels but not the actual image. It degrades image quality.

7 Technical specifications

Sensor resolution	VGA (640 x 480 pixels)
Video capture resolution (Max.)	1.2 MP (Software enhanced, with Philips CamSuite installed)
Photo resolution (Max.)	1.2 MP (Software enhanced, with Philips CamSuite installed); 5.0 MP (Software enhanced, with Philips CamSuite and Webcam Driver SPZ3000 installed)
Frames per second	30 fps Max.
Lens F-number	F2.6
Lens angle of view	50 degrees
Minimum subject illumination	< 5 lux
Video format	YUY2, RGB24 and I420 (With Webcam Driver SPZ3000 installed)
Microphone	Built-in microphone with audio enhancement
Windows® OS	Windows® 7 compliant
USB interface	USB 2.0 High speed
USB video class	UVC compliant
USB cable length	1.5 m
Power	Supplied via USB cable; 5V DC, 0.15A

System requirements for a Microsoft Windows-based PC:

- Minimum system requirements:
 - 1.6 GHz or equivalent
 - 512 MB RAM for Windows XP
 - 1 GB RAM (32Bit) for Windows Vista and Windows 7
 - OS: Windows XP SP2, Vista, and Windows 7
 - 200 MB of available hard disk space
 - One free USB2.0 port
 - Soundcard and speakers (OS-compatible)
 - 16-bits Color display @ 800x600 with DirectX 3D support
 - DirectX 9.0c or higher
 - Microsoft .Net Framework 2.0
 - Broadband Internet connection to download drivers, Philips CamSuite, and manuals
 - Adobe reader to read *PDF files
- Recommended system requirements:
 - 2.4 GHz dual core or equivalent
 - 1 GB RAM (32Bit) / 2GB RAM (64Bit) for Windows XP, Vista, and Windows 7
 - DirectX 9.0c or higher
 - Microsoft .Net Framework 2.0.
 - Broadband Internet connection
 - Adobe reader to read *PDF files

Recommended system requirements for an Apple Mac:

- Mac OS X v10.4 'Tiger' - 10.5 'Leopard'
- 200 MB of available hard disk space
- USB port 2.0

8 Frequently asked questions (FAQ)

How can I adjust image quality?

The default settings of the Philips webcam usually offer the best possible image quality.

If you have Philips CamSuite or Webcam Driver SPZ3000 installed on the PC/notebook, you can also adjust image quality via the settings provided by Philips CamSuite or Webcam Driver SPZ3000.

The microphone of my Philips SPZ3000 webcam or headset does not work (properly). What should I do?

For Windows XP (SP2):

- 1 On the PC/notebook, click **Start** > **Control panel**.
- 2 Click **Sounds and Audio Devices**.
- 3 Click the **Voice** tab in the displayed window.

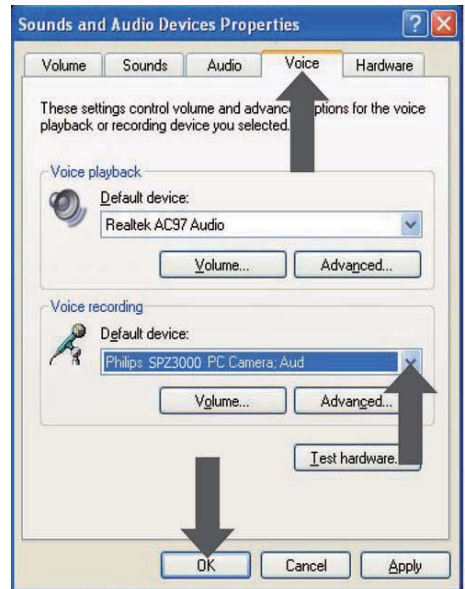

- 4 Set the Philips SPZ3000 webcam or the connected headset as default device for **Voice recording**.
- 5 Click **OK** to save your settings.

For Windows Vista:

- 1 On the PC/notebook, click **Start** > **Control panel**.
- 2 Click **Hardware and Sound**.
- 3 Click **Sound**.
- 4 Click the **Recording** tab in the displayed window.

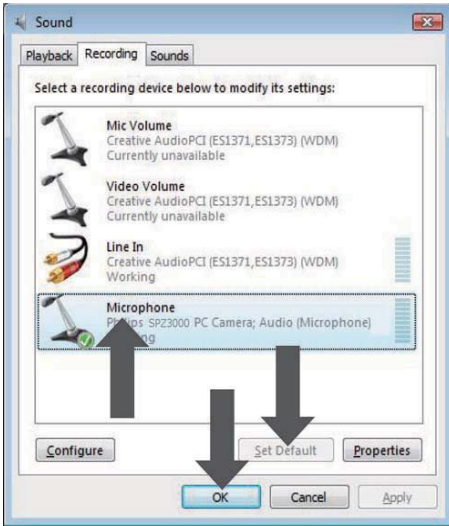

- 5 Select the Philips SPZ3000 webcam or the connected headset and click **Set Default**.
- 6 Click **OK** to save your settings.

For Windows 7:

- 1 On the PC/notebook, click **Start > Control panel**.
- 2 Click **Hardware and Sound**.
- 3 Click **Sound > Manage audio device**.
- 4 Click the **Recording** tab in the displayed window.
- 5 Select the Philips SPZ3000 webcam or the connected headset and click **Set Default**.
- 6 Click **OK** to save your settings.

Using my Philips SPZ3000 webcam makes my PC/notebook run slow. What should I do?

- 1 Close the software applications that do not necessarily need to run.

Tip

- The maximum frame rate (frames per second (fps) produced by the webcam) and the maximum image resolution depend on the specifications of your PC/notebook. With the Full automatic control feature, the webcam software will automatically adjust frame rate and resolution as good as possible for your particular situation. It might be possible that the specifications of your PC/notebook do not meet the requirements for maximum frame rate and resolution setting.

No image is available on the screen. What should I do?

- 1 Ensure that the webcam is connected properly.
- 2 Check whether you are using the webcam in another application.
- 3 Close the other application.

Tip

- You cannot use the webcam in more than one application at the same time.

9 Service and support

Need help?

First of all, read this user manual carefully.

The model number of your product is SPZ3000.

When you need further support about registration, setup, usage, features, software upgrade, specification, and warranty, etc. of the product, see www.philips.com/support.

- 1 At www.philips.com/support, click the **Choose country / language** box to select your country/language.
- 2 Click the **Search** box, enter **SPZ3000** and click the **Search** button.
- 3 Click **SPZ3000** under the search results.
- 4 Click **Support**.
 - ↳ Under **Product support**, you will find information about **Overview**, **Latest updates**, **Manuals and documentation**, **Frequently asked questions**, **Product information**, **Product registration**, and **etc..**
 - ↳ Under **Service information**, you will find information on warranty.
 - ↳ Under **Contact**, you will find telephone numbers of Philips Consumer Care helpdesk.

Information to the customer

Safety precautions

Observe the following guidelines to ensure that the webcam will operate safely and to prevent defects.

- Do not use your webcam in environments outside the following range: temperature: 0°C to 40°C, relative humidity: 45% ~ 85%.
- Do not use or store your webcam in/ under:
 - direct sunlight exposure;
 - very humid and dusty environment;
 - near any kind of heat sources.
- If your webcam gets wet, dry it with soft cloth as soon as possible.
- If the lens is dirty, do NOT touch the lens with your fingers.
- Clean the outside of the webcam with a soft cloth.
- Do NOT use cleaning fluids based on alcohol, methylated spirit, ammonia, etc.
- Do NOT attempt to disassemble or repair your webcam by yourself. Do not open the webcam. In the event of technical difficulties return it to your Philips retailer.
- Do NOT use your webcam in the water.
- Protect the webcam from oil, vapour, steam, moisture, and dust.
- Never point the webcam lens at the sun.

Copyright

Copyright © 2009 by Philips Consumer Lifestyle B.V.

All rights reserved. No part of this publication may be reproduced, transmitted, transcribed, stored in a retrieval system or translated into any language or computer language, in any form or by any means, electronic, mechanical, magnetic, optical, chemical, manual or otherwise, without prior written permission from Philips. Brands and product names are trademarks or registered trademarks of their respective companies.

Disclaimer

Philips makes no warranty of any kind with regard to this material, including, but not limited to, the implied warranties of merchantability and fitness for a particular purpose.

Philips assumes no responsibility for any error that may appear in this document. Philips makes no commitment to update nor to keep current the information contained in this document.

FCC compliance

This device complies with Part 15 of the FCC Rules.

Operation is subject to the following two conditions:

- ① **this device may not cause harmful interference, and**
- ② **this device must accept any interference received, including interference that may cause undesired operation.**

Note

- This equipment has been tested and found to comply with the limits for a Class B digital device, pursuant to Part 15 of the FCC Rules.
- These limits are designed to provide reasonable protection against harmful interference in a residential installation.

This equipment generates, uses and can radiate radio frequency energy and, if not installed and used in accordance with the instructions, may cause harmful interference to radio communications.

However, there is no guarantee that interference will not occur in a particular installation.

If this equipment does cause harmful interference to radio or television reception, which can be determined by turning the equipment off and on, the user is encouraged to try to correct the interference by one or more of the following measures:

- Reorient or relocate the receiving antenna.
- Increase the separation between the equipment and receiver.
- Connect the equipment to an outlet on a circuit different from that to which the receiver is connected.
- Consult the dealer or an experienced radio/TV technician for help.

Any unauthorized modification to this equipment could result in the revocation of the authorization to operate the equipment.

Compliance with Electro-Magnetic Field (EMF)

Koninklijke Philips Electronics N.V. manufactures and sells many products targeted at consumers, which, like any electronic apparatus, in general have the ability to emit and receive electromagnetic signals.

One of Philips' leading Business Principles is to take all necessary health and safety measures for our products, to comply with all applicable legal requirements and to stay well within the EMF standards applicable at the time of producing the products.

Philips is committed to develop, produce and market products that cause no adverse health effects. Philips confirms that if its products are handled properly for their intended use, they are safe to use according to scientific evidence available today.

Philips plays an active role in the development of international EMF and safety standards, enabling Philips to anticipate further developments in standardisation for early integration in its products.

Recycling



Your product is designed and manufactured with high quality materials and components, which can be recycled and reused.

When you see the crossed-out wheel bin symbol attached to a product, it means the product is covered by the European Directive 2002/96/EC:



Never dispose of your product with other household waste. Please inform yourself about the local rules on the separate collection of electrical and electronic products. The correct disposal of your old product helps prevent potentially negative consequences on the environment and human health.

All redundant packing material has been omitted. We have done our utmost to make the packaging easily separable into mono materials.

Please observe the local regulations regarding the disposal of packing materials.



Warning

- Plastic bags can be dangerous. To avoid danger of suffocation, keep this bag away from babies and small children.

Limitations of damages

The vendor will not be liable for any indirect, special, incidental or consequential damages (including damages for loss of business, loss of profits, or the like), whether based on breach of contract, tort (including negligence), product liability or otherwise, even if the vendor or its representatives have been advised of the possibility of such damages and even if a remedy set forth herein is found to have failed its essential purpose.

10 Glossary

B

Backlight compensation

Backlight compensation can improve the image quality when you have a scene where the background has a high illumination level (for instance when you are sitting in front of a bright light).

Black & White

It is used to convert color images to black and white.

E

Exposure

The exposure is the amount of light received by the sensor and is determined by how long the sensor is exposed to capture a snapshot or video frame. The result depends on the sensitivity of the sensor.

F

Frame rate

A frame is a single picture or still shot, that is shown as part of a larger video or movie. The frame rate is the number of frames displayed per second. The higher the frame rate, the better the video display but the higher the load on the processor.

For example, 30 fps means that the webcam will capture video at 30 frames per second.

G

Gain

In video, gain is the amount of white in a video picture.

M

Mirror

The mirror effect flips the image horizontally. This can let the Webcam and monitor as a mirror, or to take pictures of mirrored images.

S

Shutter Speed

The shutter speed determines how long the camera shutter remains open as a picture is taken. The slower the shutter speed, the longer the exposure time. The shutter speed controls the total amount of light reaching the sensor.

