

Always there to help you

Register your product and get support at
www.philips.com/welcome



GoGEAR

SA4RGA



User manual

PHILIPS

Contents

1 Important safety information 2

- General maintenance 2
- Recycling the product 3

2 Your new player 5

- What's in the box 5
 - PC software for the player 5
 - Files loaded on the player 5
- Overview 6
 - Controls 6
 - Home screen 6
 - Lock/unlock the keys 7
 - Volume reminder 7
 - Screen on/off 7

3 Get started 8

- Charge power 8
 - Charge through a USB AC/DC adapter 8
- Switch the player on or off 8
 - Automatic standby and shut-down 8

4 Music 9

- Transfer music to the player 9
- Find music on the player 9
 - Find music by song information 9
 - Find music by playlist 9
 - Find music by file folder 9
- Play music 9
 - Select play options 10
- Playlists 10
 - Add songs to a playlist-on-the-go 10
 - Remove songs from a playlist-on-the-go 10

5 FM radio 11

- Tune in to radio stations 11
- Listen to the FM radio 11
- Store preset stations 11

6 Recordings 13

- Record from the FM radio 13
- Listen to FM radio recordings 13
- Upload your recordings to a computer 13

7 Folder view 14

8 Settings 15

- Play mode 15
- Sound settings 15
- Sleep timer 15
- Display settings 15
 - Screen off timer 15
- Language 15
- Information 15
- Legal 16
- Factory settings 16

9 Update the firmware through Philips Device Manager 17

10 Troubleshooting 19

11 Technical data 20

- PC requirements 20

Need help?

Please visit

www.philips.com/welcome

where you can access a full set of supporting materials such as the user manual, the latest software updates, and answers to frequently asked questions.

1 Important safety information

General maintenance

The translation of this document is for reference only.

In the event of any inconsistency between the English version and the translated version, the English version shall prevail.

! Caution

- To avoid damage or malfunction:
- Use only power supplies listed in the user manual.
- Do not expose the product to excessive heat caused by heating equipment or direct sunlight.
- Do not drop the product or allow objects to fall on your player.
- Do not allow the product to be submerged in water. Do not expose headphone socket or battery compartment to water; as water entering the set may cause major damage.
- Active mobile phones in the vicinity may cause interference.
- Back up your files. Ensure that you retain the original files you have downloaded to your device. Philips is not responsible for any loss of data if the product becomes damaged or not readable / legible.
- Manage (transfer, delete, etc.) your music files only with the supplied music software to avoid problems.
- Do not use any cleaning agents containing alcohol, ammonia, benzene, or abrasives as these may harm the product.
- Batteries (battery pack or batteries installed) shall not be exposed to excessive heat such as sunshine, fire or the like.
- Danger of explosion if battery is incorrectly replaced. Replace only with the same or equivalent type.

About operating and storage temperatures

- Operate in a place where temperature is always between 0 and 45°C (32 to 113°F)

- Store in a place where temperature is always between -20 and 45°C (-4 to 113°F).
- Battery life may be shortened in low temperature conditions.

Replacement parts/accessories:

Visit www.philips.com/support to order replacement parts/accessories.

Hearing Safety



A pleine puissance, l'écoute prolongée du baladeur peut endommager l'oreille de l'utilisateur.



! Warning

- To prevent possible hearing damage, do not listen at high volume levels for long periods.

The maximum output voltage of the player is not greater than 150 mV.

Wide band characteristic voltage WBCV: >= 75 mV

Modifications

Modifications not authorized by the manufacturer may void user's authority to operate the product.

Copyright information

All other brands and product names are trademarks of their respective companies or organizations.

Unauthorized duplication of any recordings whether downloaded from the Internet or made from audio CDs is a violation of copyright laws and international treaties.

The making of unauthorized copies of copy-protected material, including computer programs, files, broadcasts and sound recordings, may be an infringement of copyrights and constitute a criminal offense. This equipment should not be used for such purposes.

The Windows Media and the Windows logo are registered trademarks of Microsoft Corporation in the United States and/or other countries.

Be responsible! Respect copyrights.



Philips respects the intellectual property of others, and we ask our users to do the same. Multimedia content on the internet may have been created and/or distributed without the original copyright owner's authorization.

Copying or distributing unauthorized content may violate copyright laws in various countries including yours.

Compliance with copyright laws remains your responsibility.

The recording and transfer to the portable player of video streams downloaded to your computer is intended only for use with public domain or properly licensed content. You may only use such content for your private, non-commercial use and shall respect eventual copyright instructions provided by the copyright owner of the work. Such instruction may state that no further copies shall be made. Video streams may include copy protection technology that prohibits further copying. For such situations the recording function will not work and you will be notified with a message.

Data logging

Philips is committed to improving the quality of your product and enhancing the Philips user experience. To understand the usage profile of this device, this device logs some info / data to the non-volatile memory region of the device.

These data are used to identify and detect any failures or problems you as a user may experience while using the device. The data stored, for example, will be the duration of playback in music mode, duration of playback in turner mode, how many times battery low was encountered, etc. The data stored do not reveal the content or media used on the device or the source of downloads. The data stored on the device are retrieved and used ONLY if the user returns the device to the service center and ONLY to simplify error detection and prevention. The data stored shall be made available to user on user's first request.

Recycling the product

Your product is designed and manufactured with high quality materials and components, which can be recycled and reused.

When you see the crossed-out wheel bin symbol attached to a product, it means the product is covered by the European Directive 2002/96/EC:



Never dispose of your product with other household waste. Please inform yourself about the local rules on the separate collection of electrical and electronic products. The correct disposal of your old product helps prevent potentially negative consequences on the environment and human health.

Warning

- Removal of the built-in battery invalidates the warranty and can destroy the product.
- The following removal and disposal instructions are steps that are to be performed at the end of the product's life only.

Your product contains a built-in rechargeable battery covered by the European Directive 2006/66/EC, which cannot be disposed of with normal household waste.



To safeguard the functionality and safety of your product, take your product to an official collection point or service center where a professional can remove the battery as shown:

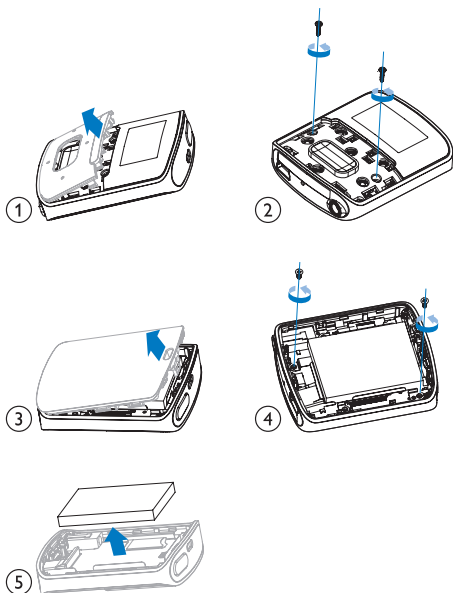

Please inform yourself about the local rules on separate collection of batteries. The correct disposal of batteries helps prevent potentially

negative consequences on the environment and human health.

Notice for the European Union

This product complies with the radio interference requirements of the European Union.

2 Your new player

Note

- The images serve as reference only. Philips reserves the right to change color/design without notice.

What's in the box

Make sure that you have received the following items:

Player



Earphones

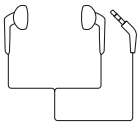

USB cable



Quick start guide



Safety and Warranty sheet



PC software for the player

RAGA can work with the following PC software:

- **Philips Device Manager** (helps you get firmware updates and recover the player)

Files loaded on the player

The following files are loaded on **RAGA**:

- User manual
- Frequently asked questions

Overview

Controls

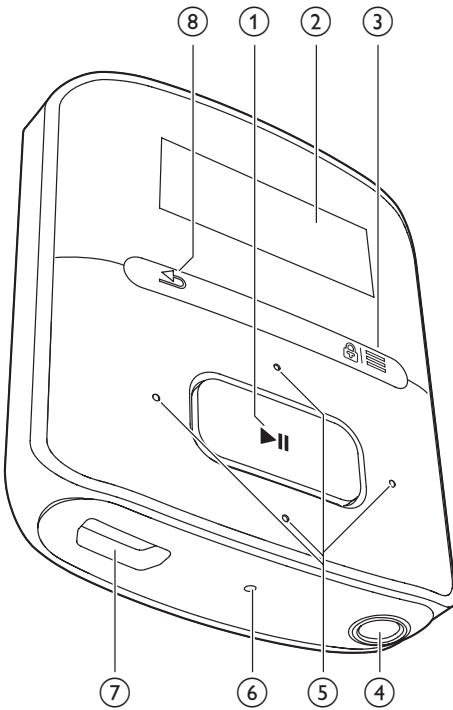

- ①
 - Press and hold: Switch the player on or off
 - Press: Select options, or start/pause/resume play
- ② **Display**
- ③ /
 - Press: Show options menu
 - Press and hold: Lock/unlock all buttons
- ④
 - 3.5-mm headphone connector
- ⑤ /
 - **on the list of options:**
Press: Skip to the previous/next option
 - **on the play screen:**

Press: Increase/decrease the volume
Press and hold: Increase/decrease the volume quickly



- **on the play screen:**
Press: Skip to the next/previous option
Press and hold: Search within current file

⑥ **RESET**

- Press the hole by using the tip of a ball pen when the screen does not respond to the pressing of keys

⑦

- USB connector for power charging and data transfer

⑧

- Press: Back one level

Home screen

Menu	Mode	To
	Music	play music
	FM radio	tune in to the FM radio; record from the FM radio
	Folder view	view files in folders
	Settings	customize the settings of RAGA
	Now playing	show current play screen

Navigate from the Home screen

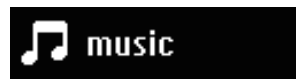

- From the Home screen, you can access functional menus by pressing the navigation buttons / and .
- To go back to previous screens, press repeatedly.

Switch between the Home screen and play screen



- On the Home screen, press and select **[Now playing]** or **[Last played]**;

- On the play screen, press  repeatedly.

- ↳ The volume level drops below the high level (80 dBA) .

Lock/unlock the keys

When the player is on, use the lock to prevent accidental operation.

- Press and hold  /  to lock or unlock the keys.
 - ↳ All buttons except the volume keys are locked and a lock icon is displayed.



Volume reminder

RAGA can have you reminded when:

- the volume reaches the high level (80 dBA); or
- you have listened at a high volume level for 20 hours.

With the feature of volume reminder; the Philips MP3/MP4 player complies with the European Union regulations (EN 60950-1) in protecting your hearing safety.

When you increase the volume,

- 1** Press .
 - ↳ When the volume level reaches the high level, a pop-up screen is displayed. Play pauses.
- 2** To continue to increase the volume, press and hold  until play resumes.
 - ↳ You can continue to increase the volume.
- To exit volume adjustment, press any other buttons or wait a few seconds until play resumes.
 - ↳ The play resumes at the previous volume level.

When you have listened at a high volume level for 20 hours, beep sounds and a pop-up is displayed. Play pauses.

- To keep listening at a high volume level, press and hold .
- To exit high volume, press any other buttons or wait until play resumes.

Screen on/off

To save power, the screen switches off automatically after the pre-defined time duration if

- no new action is taken on **RAGA**; and
- a value is selected in *** > [Display settings] > [Screen off timer]**.

To exit the power-saving mode

- Press any key.

3 Get started

Charge power

RAGA has a built-in battery that can be charged through the USB socket of a computer. Connect **RAGA** to a PC by using the USB cable.

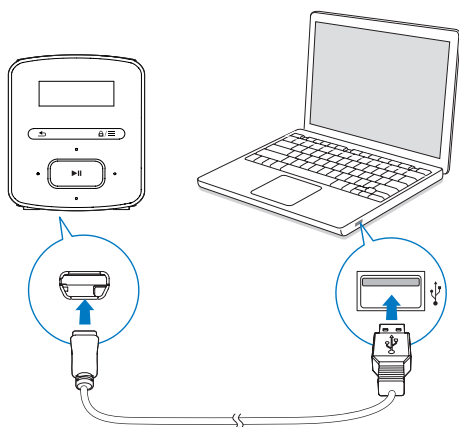

Note

- When you connect **RAGA** to a computer, you are briefly prompted to select: **[Charge & transfer]** or **[Charge & play]**.
- **RAGA** automatically applies **[Charge & transfer]**, if no new selection is made.

Battery level indication

- When the battery is low, the low battery screen is displayed repeatedly.
- When the charging process is complete,  is displayed.

Note

- Rechargeable batteries have a limited number of charge cycles. Battery life and number of charge cycles vary by use and settings.

To conserve battery power and increase the play time, do the following on **RAGA**:

- Set the backlight timer to a low value (go to  > **[Display settings]** > **[Backlight timer]**).

Charge through a USB AC/DC adapter

To charge **RAGA** through a USB AC/DC adapter (not supplied), make sure that the power output is 5.0V and 0.5A.

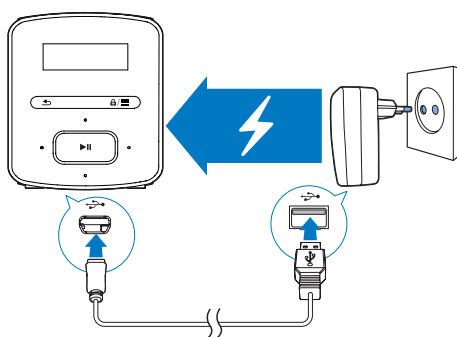

Switch the player on or off

Press and hold  until the player is switched on or off.

Automatic standby and shut-down

The player has an automatic standby and shut-down feature that can save battery power. After 5 minutes in idle mode (no play, no button is pressed), the player switches off.

4 Music

Transfer music to the player

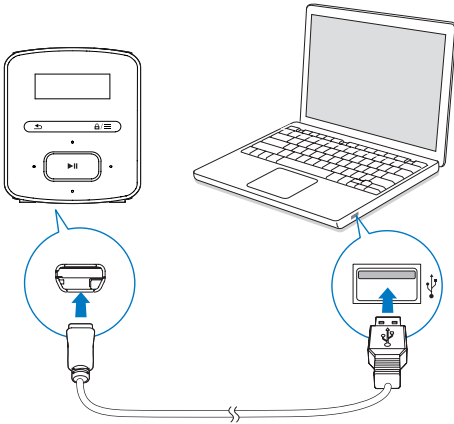

You can transfer music from your PC media library to **RAGA** in the following ways:

- Drag and drop music files in Windows Explorer:

To drag and drop music files in Windows Explorer,

- 1 Connect **RAGA** to a PC.
- 2 On the PC, under **My Computer** or **Computer**,
 - select **RAGA**, and create file folders.
- 3 On the PC, drag and drop music files to the file folders on **RAGA**.
 - Alternatively, drag and drop file folders from the PC to **RAGA**.

Find music on the player

On **RAGA**, you can find music by song information, playlist, or file folder:

Find music by song information

In **🎵**, songs are sorted by metadata or ID3 tag under different collections: **[All songs]**, **[Artists]**, or **[Albums]**.

[All songs]

- Songs are sorted by song title in alphabetical order.

[Artists]

- Songs are sorted by artist in alphabetical order;
- Under each artist, songs are sorted by album in alphabetical order.

[Albums]

- Songs are sorted by album in alphabetical order.

Find music by playlist

In **🎵** > **[Playlists]**, you can find the following playlists:

- three playlists-on-the-go for you to add songs on the player;
- playlists that you transfer from your PC media library through **Songbird**.

Find music by file folder

In **📁**, find music by file folder:

Play music

You can start play from a song, or play an entire album or artist.

To start play from a song,

- 1 Select a song.
- 2 Press **▶||** to start play.
 - ↳ Play starts from current song.

To play the entire album or artist,

- 1 Select an album or artist.
- 2 Press **≡** > **[Play]**.

3 Press ►|| to start play.
On the play screen,



- Press ►|| to pause and resume play.
- To go to the previous screen, press ⏪.
 - ↳ The play screen returns a few seconds later.
 - ↳ On the play screen, you can see the file information and play status.

To adjust the volume,

- Press 🔊 / 🔊.

To select a music file on the play screen,

- Repeatedly press 🔍 / 🔍.

To rewind or fast forward within current song,

- On the play screen, press and hold ⏮ / ⏭.

Select play options

On the play screen, press ≡ to select play options, such as play mode, sound settings, and sleep timer (see 'Settings' on page 15).

Playlists

On the players, you can find the following playlists:

- playlists that you transfer from the PC media library;
- three playlists-on-the-go for you to add songs on the player.

Add songs to a playlist-on-the-go

To add current song,

- 1 On the play screen, press ≡ > [Add to playlist].
- 2 Select a playlist-on-the-go. Press ►||.
- 3 Select [Yes] to confirm.
 - ↳ You save current song to the playlist.

Remove songs from a playlist-on-the-go

Remove current song from a playlist

- 1 On the play screen, press ≡ > [Remove from Playlist].
- 2 Select a playlist-on-the-go. Press ►||.
- 3 Select [Yes] to confirm.
 - ↳ You remove current song from the selected playlist.

5 FM radio

Note

- Plug in the supplied earphones when you tune in to radio stations. The earphones double as antenna. For better reception, move the earphone cable in different directions.

Tune in to radio stations

Auto tune

The first time you tune in to the radio, start Auto tune to search for stations.

- 1 From the Home screen, go to > [Auto tune].
↳ Up to 20 stations are stored as presets.
- 2 Press or repeatedly to select a preset station. Press to start play.

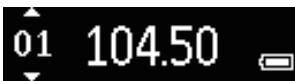

To select a preset on the play screen,

- Press or repeatedly.

Tip

- When you move to a new place (such as a new city or country), restart auto tune for better reception.

Manual tune

Use Manual tune to search for a frequency or station.

- 1 From the Home screen, go to > [Manual tuning].
↳ The last played station starts to play.
- 2 On the play screen, press and hold or .
↳ You tune in to the next station from current frequency.

- For fine tuning, press or repeatedly.



Listen to the FM radio

- 1 Go to > [Presets].
- 2 Press or to select a preset station. Press to start play.
 - Press to select another preset station from [Presets]. Press to start play.
 - On the play screen, press or to select a preset.
- 3 If necessary, press and hold or to tune in to a radio station.

To mute or unmute the radio play,

- On the play screen, press .

To adjust the volume,

- On the play screen, press or .

Store preset stations



On RAGA, you can store up to 20 preset stations.

- 1 Tune in to a radio station.
- 2 On the play screen, press > [Save to preset].
- 3 Press or to select a location in the list of presets. Press .
↳ Current station is saved to the location.

To remove current preset station,

- 1 In [Presets], press > [Clear preset].
- 2 Select the station in the list of presets. Press .
- 3 Select [Yes] to confirm.
↳ Current station is removed from the list of presets.

Alternatively,

- 1 On the play screen, press  > **[Clear preset]**.
- 2 Select the station in the list of presets.
Press .
- 3 Select **[Yes]** to confirm.
↳ Current station is removed from the list of presets.

To remove all preset stations,

- 1 Go to **[Presets]**.
- 2 On the list of presets, press  > **[Clear all presets]**.
- 3 Select **[Yes]** to confirm.
↳ All the stations are removed from the list of presets.

6 Recordings

Go to > [FM Recording] to listen to the radio programs that you record from the FM radio.

Record from the FM radio

- 1 Tune in to a radio station.
- 2 On the play screen, press and select [Start FM radio recording] to start recording.
↳ You start recording from the FM radio.
- 3 Press to toggle between pause and record. Press to stop.
- 4 Select [Yes] to save the recording.
↳ Recordings are saved to > [FM Recording] > RECORD > RADIO.
(Filename format: FMRECXXX.WAV, where XXX is the recording number that is generated automatically.)



Tip

- You can also find the recordings in > RECORD.
- The feature of FM radio recording is available with some versions only. Refer to the onscreen menu of the player to find out which features are available to you.

Listen to FM radio recordings

- 1 In > [FM Recording] > RECORD > RADIO, select a recording.
- 2 Press to play your recording.
To select a file on the play screen,
 - Repeatedly press / .To rewind or fast forward within current file,
 - On the play screen, press and hold / .

Upload your recordings to a computer

- 1 Connect RAGA to a computer.
- 2 On the PC, under My Computer or Computer,
 - select RAGA;
 - in RAGA, select recordings in RECORD > RADIO.
- 3 Drag and drop the recording files to a location on the PC.

7 Folder view

Go to  to view and play media files from the media library on the player.

8 Settings

In *****, select your options for the player:

- 1 Press / to select an option.
- 2 Press to confirm.

Play mode

In **[Play mode]**, select play modes for music play:

[Repeat]

- **[Repeat 1]:** Repeats current song.
- **[Repeat all]:** Repeats all songs in current folder.

[Shuffle]

- **[On]:** Plays all songs in current folder in random order.

If both **[Repeat all]** and **[Shuffle]** are activated,

- All songs in current folder are repeated in random order.

Sound settings

In **[Sound settings]**, select your option for sound settings:

[FullSound]: Restores the sonic details that music compression loses (for example, MP3, WMA).

[Equalizer]: Defines sound settings as desired.

[Volume limit]: Sets a maximum volume level for the device. In this way, you can always keep the volume within a level safe enough to your hearing.

Press / to set the volume limit; Press to confirm.

Note

- Equalizer is deactivated when you select FullSound.

Sleep timer

Switch on the sleep timer. The **RAGA** can switch off automatically after a certain time duration.

- In **[Sleep timer] > [Sleep timer]**, select an option. Press .
 - ↳ After the selected time duration, the device is switched off automatically.

Display settings

Screen off timer

The screen enters the idle mode, if no new action is taken on **RAGA**. After the pre-defined time duration, the idle screen is switched off automatically. To save battery power, select a low value for the time duration.

To set the time duration

- In **[Display settings] > [Screen off timer]**, select a time duration.
 - ↳ After the selected time duration, the idle screen is switched off automatically.

To exit the power-saving mode

- Press any key.

Language

In **[Language]**, select a language for the player:

Information

In **[Information]**, learn the following information about the player:

[Player information]

- **[Model:]** full product name

Check the full product name when you update firmware from the Support site.

- **[Firmware version:]** current firmware version

Check the firmware version when you update firmware from the Support site.

[Disk space]

- **[Free space:]** space available
- **[Total space:]** memory size
- **[Songs]** number of songs that are stored on the player

[File type supported] file formats that are supported on the player

Legal

In **[Legal]**, find the legal information about the player.

Factory settings

In **[Factory settings]**, restore the player to factory settings. Files transferred to the player are retained.

9 Update the firmware through Philips Device Manager

Install Philips Device Manager

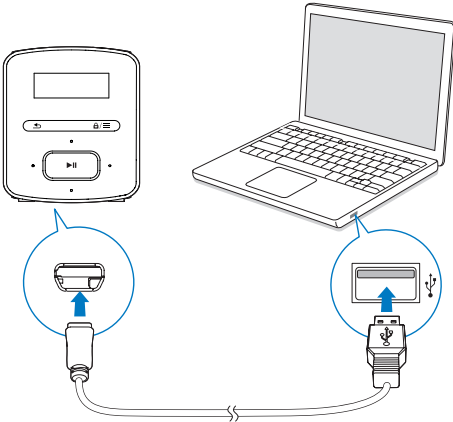

- 1 Connect **RAGA** to a PC.
- 2 On the PC, select **My Computer** (Windows XP / Windows 2000) / **Computer** (Windows Vista / Windows 7 / 8).
- 3 Right click on the **Philips GoGear RAGA** icon. Select **Install Philips Device Manager**.
 - Alternatively, click the **Philips GoGear RAGA** icon. Double-click the **installer.exe**.
- 4 Follow the onscreen instructions to complete the installation of the software.

Note

- The installation requires you to agree to the license terms.

Check for firmware updates

- 1 Make sure that you have connected your PC to the Internet.
- 2 Launch **Philips Device Manager**.
 - ↳ A dialog box is displayed.
- 3 Connect **RAGA** to your PC.
 - ↳ When the device is connected, "SA4RGAXX" is displayed on the text box.
 - ↳ You can find current firmware version of the device.



- 4 To check for firmware updates,
 - ① Close the dialog box of Philips Device Manager.
 - ② At the base of the PC screen, right click  and select Check for updates.

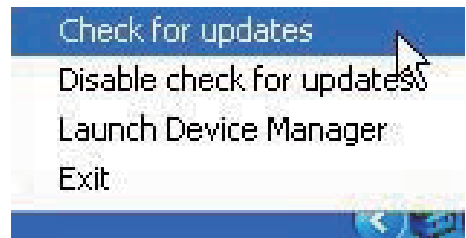

- ↳ **Philips SA4RGAXX Device Manager** checks for updates from the Internet.

Update the firmware

- 1** When the firmware update is available, follow the onscreen instructions to download and install the firmware.
- 2** Disconnect **RAGA** from the PC.
 - ↳ **RAGA** restarts after the firmware is updated and is ready for use again,

10 Troubleshooting

If **RAGA** is not working properly or the display freezes, you can reset it without losing data:

How do I reset RAGA?

- Insert a pen tip or other object into the reset hole on **RAGA**. Hold until the player shuts down.
- If the reset option is unsuccessful, recover **RAGA** through **Philips Device Manager**:

- 1** On your PC, launch **Philips Device Manager**.
- 2** Enter the recovery mode:
 - ①** Switch off **RAGA**.
 - ②** Press and hold the volume button , and then, connect **RAGA** to your PC.
 - ③** Keep holding the button until **Philips Device Manager** recognizes **RAGA** and enters the recovery mode.
- 3** Start the recovery process:
 - ①** On **Philips Device Manager**, click the **Repair** button. Follow the onscreen instructions to complete the recovery process.
 - ②** When the recovery is completed, disconnect **RAGA** from your PC.
- 4** Restart **RAGA**.

11 Technical data

Power

- Power supply: 220 mAh Li-ion polymer internal rechargeable battery
- Play time¹
Audio (.mp3): up to 20 hours
Radio: up to 8 hours

Software

- **Philips Device Manager:** To update the firmware and recover the player

Connectivity

- Headphone 3.5 mm
- USB 2.0 High speed

Sound

- Channel separation: 45 dB
- Frequency Response: 20-18,000 Hz
- Output power: 2 x 2.4 mW
- Signal to noise ratio: > 84 dB

Audio playback

Supported formats:

- MP3
Bitrate: 8-320 kbps and VBR
Sampling rates: 8, 11.025, 16, 22.050, 32, 44.1, 48 kHz
- WMA (unprotected)
Bitrate: 10-320 kbps CBR, 32-192 kbps VBR
Sampling rates: 8, 11.025, 16, 22.050, 32, 44.1, 48 kHz
- WAV

Storage media

Built-in memory capacity²:

- SA4RGA02 2 GB NAND Flash
- SA4RGA04 4 GB NAND Flash
- SA4RGA08 8 GB NAND Flash

Media transfer³

- Windows Explorer (drag and drop)

Display

- LCD 128 x 32 pixels

Note

- Specifications are subject to change without notice.
- ¹ Rechargeable batteries have a limited number of charge cycles. Battery life and number of charge cycles vary by use and settings.
- ² 1 GB = 1 billion bytes; available storage capacity is less. Full memory capacity may not be available as some memory is reserved for the player. Storage capacity is based on 4 minutes per song and 128-kbps MP3 encoding.
- ³ Transfer speed depends on operating system and software configuration.

PC requirements

- Windows® XP (SP3 or above) / Vista / 7 / 8
- Pentium III 800 MHz processor or higher
- 512 MB RAM
- 500 MB hard disk space
- Internet connection
- Windows® Internet Explorer 6.0 or later
- USB port



Specifications are subject to change without notice
2013 © WOOX Innovations Limited. All rights reserved.
Philips and the Philips' Shield Emblem are registered trademarks of
Koninklijke Philips N.V. and are used by WOOX Innovations Limited
under license from Koninklijke Philips N.V.

SA4RGA_12_UM_V3.0_WK1351.5