

Always there to help you

Register your product and get support at
www.philips.com/welcome



GoGEAR

SA4RGA02

SA4RGA04

SA4RGA08



User manual

PHILIPS

Contents

1	Important safety information	2
	General maintenance	2
	Recycling the product and the built-in battery	3

2	Your new player	5
	What's in the box	5
	PC software for the player	5
	Files loaded on the player	5
	Overview	6
	Controls	6
	Home screen	6
	Lock/unlock the keys	7
	Screen on/off	7

3	Get started	8
	Charge power	8
	Charge through a USB AC/DC adapter	8
	Switch the player on or off	8
	Automatic standby and shut-down	8

4	Music	9
	Transfer music to the player	9
	Find music on the player	9
	Find music by song information	9
	Find music by playlist	9
	Find music by file folder	9
	Play music	9
	Select play options	10
	Playlists	10
	Add songs to a playlist-on-the-go	10
	Remove songs from a playlist-on-the-go	10

5	FM radio	11
	Tune in to radio stations	11
	Listen to the FM radio	11
	Store preset stations	11

6	Folder view	13
----------	--------------------	-----------

7	Settings	14
	Play mode	14
	Sound settings	14
	Sleep timer	14
	Display settings	14
	Theme	14
	Backlight timer	14
	Language	14
	Information	15
	Legal	15
	Factory settings	15

8	Update the firmware through Philips Device Manager	16
----------	---	-----------

9	Troubleshooting	18
----------	------------------------	-----------

10	Technical data	19
	PC requirements	19

Need help?

Please visit

www.philips.com/welcome

where you can access a full set of supporting materials such as the user manual, the latest software updates, and answers to frequently asked questions.

1 Important safety information

General maintenance

The translation of this document is for reference only.

In the event of any inconsistency between the English version and the translated version, the English version shall prevail.

Caution

- To avoid damage or malfunction:
- Do not expose the product to excessive heat caused by heating equipment or direct sunlight.
- Do not drop the product or allow objects to fall on your player.
- Do not allow the product to be submerged in water; Do not expose headphone socket or battery compartment to water; as water entering the set may cause major damage.
- Active mobile phones in the vicinity may cause interference.
- Back up your files. Ensure that you retain the original files you have downloaded to your device. Philips is not responsible for any loss of data if the product becomes damaged or not readable / legible.
- Manage (transfer, delete, etc.) your music files only with the supplied music software to avoid problems.
- Do not use any cleaning agents containing alcohol, ammonia, benzene, or abrasives as these may harm the product.
- Batteries (battery pack or batteries installed) shall not be exposed to excessive heat such as sunshine, fire or the like.
- Danger of explosion if battery is incorrectly replaced. Replace only with the same or equivalent type.

About operating and storage temperatures

- Operate in a place where temperature is always between 0 and 45°C (32 to 113°F)
- Store in a place where temperature is always between -20 and 45°C (-4 to 113°F).

- Battery life may be shortened in low temperature conditions.

Replacement parts/accessories:

Visit www.philips.com/support to order replacement parts/accessories.

Hearing Safety



Listen at a moderate volume:

Using headphones at a high volume can impair your hearing. This product can produce sounds in decibel ranges that may cause hearing loss for a normal person, even for exposure less than a minute. The higher decibel ranges are offered for those that may have already experienced some hearing loss.

Sound can be deceiving. Over time your hearing 'comfort level' adapts to higher volumes of sound. So after prolonged listening, what sounds 'normal' can actually be loud and harmful to your hearing. To guard against this, set your volume to a safe level before your hearing adapts and leave it there.

To establish a safe volume level:

Set your volume control at a low setting. Slowly increase the sound until you can hear it comfortably and clearly, without distortion.

Listen for reasonable periods of time:

Prolonged exposure to sound, even at normally 'safe' levels, can also cause hearing loss.

Be sure to use your equipment reasonably and take appropriate breaks.

Be sure to observe the following guidelines when using your headphones.

Listen at reasonable volumes for reasonable periods of time.

Be careful not to adjust the volume as your hearing adapts.

Do not turn up the volume so high that you can't hear what's around you.

You should use caution or temporarily discontinue use in potentially hazardous situations.

Do not use headphones while operating a motorized vehicle, cycling, skateboarding, etc.; it may create a traffic hazard and is illegal in many areas.

Modifications

Modifications not authorized by the manufacturer may void user's authority to operate the product.

Copyright information

All other brands and product names are trademarks of their respective companies or organizations.

Unauthorized duplication of any recordings whether downloaded from the Internet or made from audio CDs is a violation of copyright laws and international treaties.

The making of unauthorized copies of copy-protected material, including computer programs, files, broadcasts and sound recordings, may be an infringement of copyrights and constitute a criminal offense. This equipment should not be used for such purposes.

The Windows Media and the Windows logo are registered trademarks of Microsoft Corporation in the United States and/or other countries.

Be responsible! Respect copyrights.



**Be responsible
Respect copyrights**

Philips respects the intellectual property of others, and we ask our users to do the same. Multimedia content on the internet may have been created and/or distributed without the original copyright owner's authorization. Copying or distributing unauthorized content may violate copyright laws in various countries including yours. Compliance with copyright laws remains your responsibility. The recording and transfer to the portable player of video streams downloaded to your

computer is intended only for use with public domain or properly licensed content. You may only use such content for your private, non-commercial use and shall respect eventual copyright instructions provided by the copyright owner of the work. Such instruction may state that no further copies shall be made. Video streams may include copy protection technology that prohibits further copying. For such situations the recording function will not work and you will be notified with a message.

Data logging

Philips is committed to improving the quality of your product and enhancing the Philips user experience. To understand the usage profile of this device, this device logs some info / data to the non-volatile memory region of the device. These data are used to identify and detect any failures or problems you as a user may experience while using the device. The data stored, for example, will be the duration of playback in music mode, duration of playback in turner mode, how many times battery low was encountered, etc. The data stored do not reveal the content or media used on the device or the source of downloads. The data stored on the device are retrieved and used ONLY if the user returns the device to the Philips service center and ONLY to simplify error detection and prevention. The data stored shall be made available to user on user's first request.

Recycling the product and the built-in battery

Your product is designed and manufactured with high quality materials and components, which can be recycled and reused. Never dispose of your product with other household waste. Please inform yourself about the local rules on the separate collection of electrical and electronic products and batteries.

The correct disposal of these products helps prevent potentially negative consequences on the environment and human health.

Please visit www.recycle.philips.com for additional information on a recycling center in your area.

! **Caution**

- Removal of the built-in battery invalidates the warranty and can destroy the product.

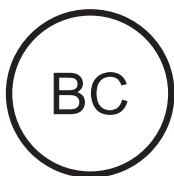

RAGA

Philips

Notice for the USA

This equipment has been tested and found to comply with the limits for a Class B digital device, pursuant to part 15 of the FCC Rules.

These limits are designed to provide reasonable protection against harmful interference in a residential installation. This equipment generates, uses, and can radiate radio frequency energy and, if not installed and used in accordance with the instruction manual, may cause harmful interference to radio communications.

However, there is no guarantee that interference will not occur in a particular installation. If this equipment does cause harmful interference to radio or television reception, which can be determined by turning the equipment off and on, the user is encouraged to try to correct the interference by one or more of the following measures:

- Relocate the receiving antenna.

- Increase the separation between equipment and receiver.
- Connect the equipment into an outlet on a circuit different from that to which the receiver is connected.
- Consult the dealer or an experienced radio/TV technician for help.

The set complies with the FCC-Rules, Part-15 and with 21 CFR 1040.10. Operation is subject to the following two conditions:

- This device may not cause harmful interference, and
- This device must accept any interference received, including interference that may cause undesired operation.

Notice for Canada

This Class B digital apparatus complies with Canadian ICES-003.

2 Your new player

Note

- The images serve as reference only. Philips reserves the right to change color/design without notice.

What's in the box

Make sure that you have received the following items:

Player



Earphones

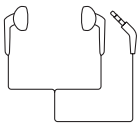

USB cable



Quick start guide



Safety and Warranty sheet



PC software for the player

RAGA can work with the following PC software:

- **Philips Device Manager** (helps you get firmware updates and recover the player)
- **Songbird** (helps you manage your media library on a PC and the player)
Get Songbird from www.philips.com/songbird.

Files loaded on the player

The following files are loaded on **RAGA**:

- User manual
- Frequently asked questions

Overview

Controls

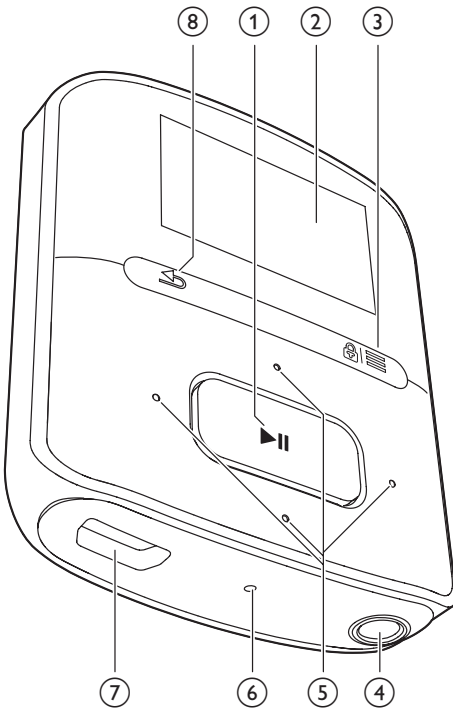

- ① **▶||**
 - Press and hold: Switch the player on or off
 - Press: Select options, or start/pause/resume play
- ② **Display**
- ③ **🔒 / ☰**
 - Press: Show options menu
 - Press and hold: Lock/unlock all buttons
- ④ **🎧**
 - 3.5-mm headphone connector
- ⑤ **⏪ / ⏩**
 - **on the list of options:**
Press: Skip to the previous/next option
 - **on the play screen:**

Press: Increase/decrease the volume
Press and hold: Increase/decrease the volume quickly



- **on the play screen:**
Press: Skip to the next/previous option
Press and hold: Search within current file

⑥ **RESET**

- Press the hole by using the tip of a ball pen when the screen does not respond to the pressing of keys

⑦ **🔌**

- USB connector for power charging and data transfer

⑧ **↶**

- Press: Back one level

Home screen



Menu	Mode	To
🎵	Music	play music
📻	FM radio	tune in to the FM radio
📁	Folder view	view files in folders
⚙️	Settings	customize the settings of RAGA
🎧	Now playing	show current play screen

Navigate from the Home screen



- From the Home screen, you can access functional menus by pressing the navigation buttons **⏪ / ⏩** and **▶||**.
- To go back to previous screens, press **↶** repeatedly.

Switch between the Home screen and play screen

- On the Home screen, press  and select **[Now playing]** or **[Last played]**;
- On the play screen, press  repeatedly.



Select a theme

To select a theme for the display,

- On the Home screen, press  and select **[Theme]**.

Lock/unlock the keys

When the player is on, use the lock to prevent accidental operation.

- Press and hold  /  to lock or unlock the keys.
 - ↳ All buttons except the volume keys are locked and a lock icon is displayed.

Screen on/off

To save power, the screen switches off automatically after the pre-defined time duration if

- no new action is taken on **RAGA**; and
- a value is selected in  > **[Display settings]** > **[Backlight timer]**.

To exit the power-saving mode

- Press any key.

3 Get started

Charge power

RAGA has a built-in battery that can be charged through the USB socket of a computer. Connect **RAGA** to a PC by using the USB cable.

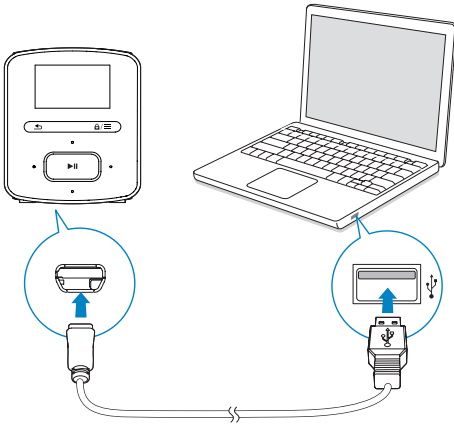

Note

- When you connect **RAGA** to a computer, you are briefly prompted to select: **[Charge & transfer]** or **[Charge & play]**.
- **RAGA** automatically applies **[Charge & transfer]**, if no new selection is made.

Battery level indication

- When the battery is low, the low battery screen is displayed repeatedly.
- When the charging process is complete,  is displayed.

Note

- Rechargeable batteries have a limited number of charge cycles. Battery life and number of charge cycles vary by use and settings.

To conserve battery power and increase the play time, do the following on RAGA:

- Set the backlight timer to a low value (go to  > **[Display settings]** > **[Backlight timer]**).

Charge through a USB AC/DC adapter

To charge **RAGA** through a USB AC/DC adapter (not supplied), make sure that the power output is 5.0V and 0.5A.

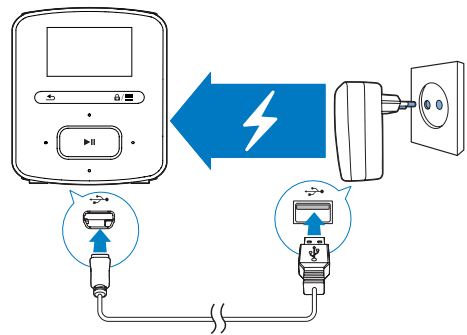

Switch the player on or off

Press and hold  until the player is switched on or off.

Automatic standby and shut-down

The player has an automatic standby and shut-down feature that can save battery power. After 5 minutes in idle mode (no play, no button is pressed), the player switches off.

4 Music

Transfer music to the player

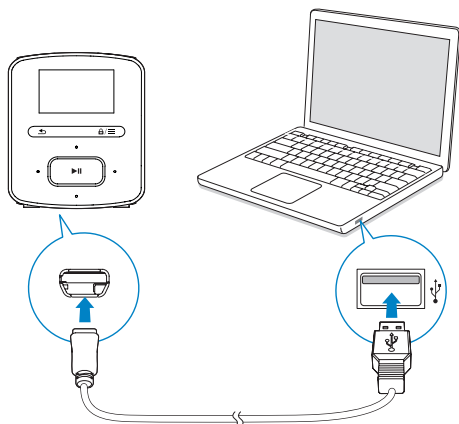

You can transfer music from your PC media library to **RAGA** in the following ways:

- Drag and drop music files in Windows Explorer;
By doing so, you can organize your music collection by file folder.
- Sync through Philips Songbird.

With the media management software, you can access online music stores, create playlists, or edit your music collection by song information. Download **Songbird** www.philips.com/songbird. To drag and drop music files in Windows Explorer,

- 1 Connect **RAGA** to a PC.
- 2 On the PC, under **My Computer** or **Computer**,
 - select **RAGA**, and create file folders.
- 3 On the PC, drag and drop music files to the file folders on **RAGA**.
 - Alternatively, drag and drop file folders from the PC to **RAGA**.

Find music on the player

On **RAGA**, you can find music by song information, playlist, or file folder.

Find music by song information

In **♪**, songs are sorted by metadata or ID3 tag under different collections: **[All songs]**, **[Artists]**, or **[Albums]**.

[All songs]

- Songs are sorted by song title in alphabetical order.

[Artists]

- Songs are sorted by artist in alphabetical order;
- Under each artist, songs are sorted by album in alphabetical order.

[Albums]

- Songs are sorted by album in alphabetical order.

Find music by playlist

In **♪ >** **[Playlists]**, you can find the following playlists:

- three playlists-on-the-go for you to add songs on the player;
- playlists that you transfer from your PC media library through **Songbird**.

Find music by file folder

In **■**, find music by file folder.

Play music

You can start play from a song, or play an entire album or artist.

To start play from a song,

- 1 Select a song.

- 2 Press ►► to start play.
↳ Play starts from current song.

To play the entire album or artist,

- 1 Select an album or artist.
- 2 Press ≡ > [Play].
- 3 Press ►► to start play.

On the play screen,

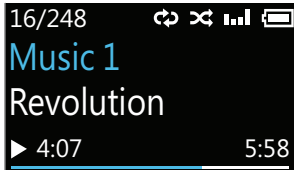

- Press ►► to pause and resume play.
- To go to the previous screen, press ⏪.
↳ The play screen returns a few seconds later.
↳ On the play screen, you can see the file information and play status.

To adjust the volume,

- Press 🔊 / 🔊.

To select a music file on the play screen,

- Repeatedly press 🔍 / 🔍.

To rewind or fast forward within current song,

- On the play screen, press and hold ⏮ / ⏭.

Select play options

On the play screen, press ≡ to select play options, such as play mode, sound settings, and sleep timer (see 'Settings' on page 14).

Playlists

On the players, you can find the following playlists:

- playlists that you transfer from the PC media library;
- three playlists-on-the-go for you to add songs on the player.

Add songs to a playlist-on-the-go

To add current song,

- 1 Select or play a song.
- 2 On the list of songs or play screen,
 - press ≡ and select [Add to playlist].
- 3 Select a playlist-on-the-go. Press ►►.
- 4 Select [Yes] to confirm.
↳ You save current song to the playlist.

To add an album or artist,

- 1 Select an album or artist.
- 2 On the list of albums or artists,
 - press ≡ and select [Add to playlist].
- 3 Select a playlist-on-the-go. Press ►►.
- 4 Select [Yes] to confirm.
↳ You save the album or artist to the playlist.

Remove songs from a playlist-on-the-go

Remove current song from a playlist

- 1 On the play screen, press ≡ > [Remove from Playlist].
- 2 Select a playlist-on-the-go. Press ►►.
- 3 Select [Yes] to confirm.
↳ You remove current song from the selected playlist.

5 FM radio

Note

- Plug in the supplied earphones when you tune in to radio stations. The earphones double as antenna. For better reception, move the earphone cable in different directions.

Tune in to radio stations

Auto tune

The first time you tune in to the radio, start Auto tune to search for stations.

- 1 From the Home screen, go to > [Auto tune].
↳ Up to 20 stations are stored as presets.

- 2 Press or repeatedly to select a preset station. Press to start play.

To select a preset on the play screen,

- Press or repeatedly.

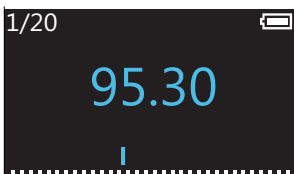

Tip

- When you move to a new place (such as a new city or country), restart auto tune for better reception.

Manual tune

Use Manual tune to search for a frequency or station.

- 1 From the Home screen, go to > [Manual tuning].
↳ The last played station starts to play.
- 2 On the play screen, press and hold or .

↳ You tune in to the next station from current frequency.

- For fine tuning, press or repeatedly.

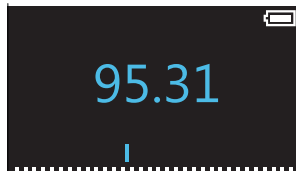

Listen to the FM radio

- 1 Go to > [Presets].
- 2 Press or to select a preset station. Press to start play.
 - Press to select another preset station from [Presets]. Press to start play.
 - On the play screen, press or to select a preset.
- 3 If necessary, press and hold or to tune in to a radio station.

To mute or unmute the radio play,

- On the play screen, press .

To adjust the volume,

- On the play screen, press or .

Store preset stations

On RAGA, you can store up to 20 preset stations.

- 1 Tune in to a radio station.
 - 2 On the play screen, press > [Save to preset].
 - 3 Press or to select a location in the list of presets. Press .
- ↳ Current station is saved to the location.

To remove current preset station,

- 1 In [Presets], press > [Clear preset].

- 2 Select the station in the list of presets.
Press ►||.
- 3 Select [Yes] to confirm.
↳ Current station is removed from the list of presets.

Alternatively,

- 1 On the play screen, press ≡ > [Clear preset].
- 2 Select the station in the list of presets.
Press ►||.
- 3 Select [Yes] to confirm.
↳ Current station is removed from the list of presets.

To remove all preset stations,

- 1 Go to [Presets].
- 2 On the list of presets, press ≡ > [Clear all presets].
- 3 Select [Yes] to confirm.
↳ All the stations are removed from the list of presets.

6 Folder view

Go to ■ to view and play media files from the media library on the player.

7 Settings

In *****, select your options for the player:

- 1 Press **⏮** / **⏭** to select an option.
- 2 Press **▶||** to confirm.

Play mode

In **[Play mode]**, select play modes for music play:

[Repeat]

- **[Repeat 1]**: Repeats current song.
- **[Repeat all]**: Repeats all songs in current folder.

[Shuffle]

- **[On]**: Plays all songs in current folder in random order.

If both **[Repeat all]** and **[Shuffle]** are activated,

- All songs in current folder are repeated in random order.

Sound settings

In **[Sound settings]**, select your option for sound settings:

[FullSound]: Restores the sonic details that music compression loses (for example, MP3, WMA).

[Equalizer]: Defines sound settings as desired.

[Volume limit]: Sets a maximum volume level for the device. In this way, you can always keep the volume within a level safe enough to your hearing.

Press **⏮** / **⏭** to set the volume limit; Press **▶||** to confirm.



Note

- Equalizer is deactivated when you select FullSound.

Sleep timer

Switch on the sleep timer. The **RAGA** can switch off automatically after a certain time duration.

- In **[Sleep timer] > [Sleep timer]**, select an option. Press **▶||**.
 - ↳ After the selected time duration, the device is switched off automatically.

Display settings

Theme

In **[Display settings] > [Theme]**, select the theme for the display.

Backlight timer

The screen enters the idle mode, if no new action is taken on **RAGA**. After the pre-defined time duration, the idle screen is switched off automatically. To save battery power, select a low value for the time duration.

To set the time duration

- In **[Display settings] > [Backlight timer]**, select a time duration.
 - ↳ After the selected time duration, the idle screen is switched off automatically.

To exit the power-saving mode

- Press any key.

Language

In **[Language]**, select a language for the player.

Information

In **[Information]**, learn the following information about the player:

[Player information]

- **[Model:]** full product name
Check the full product name when you update firmware from the Support site.
- **[Firmware version:]** current firmware version
Check the firmware version when you update firmware from the Support site.

[Disk space]

- **[Free space:]** space available
- **[Total space:]** memory size
- **[Songs]** number of songs that are stored on the player

[File type supported] file formats that are supported on the player

Legal

In **[Legal]**, find the legal information about the player.

Factory settings

In **[Factory settings]**, restore the player to factory settings. Files transferred to the player are retained.

8 Update the firmware through Philips Device Manager

Install Philips Device Manager

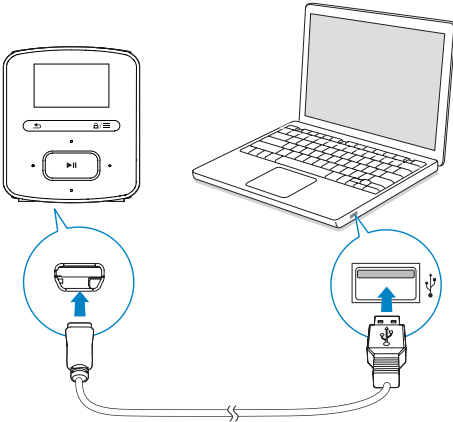

- 1 Connect **RAGA** to a PC.
- 2 On the PC, select **My Computer** (Windows XP / Windows 2000) / **Computer** (Windows Vista / Windows 7 / 8).
- 3 Right click on the **Philips GoGear RAGA** icon. Select **Install Philips Device Manager**.
 - Alternatively, click the **Philips GoGear RAGA** icon. Double-click the **installer.exe**.
- 4 Follow the onscreen instructions to complete the installation of the software.

Note

- The installation requires you to agree to the license terms.

Check for firmware updates

- 1 Make sure that you have connected your PC to the Internet.
- 2 Launch **Philips Device Manager**.
 - ↳ A dialog box is displayed.
- 3 Connect **RAGA** to your PC.
 - ↳ When the device is connected, "SA4RGAXX" is displayed on the text box.
 - ↳ You can find current firmware version of the device.



- 4 To check for firmware updates,
 - ① Close the dialog box of Philips Device Manager.
 - ② At the base of the PC screen, right click  and select Check for updates.

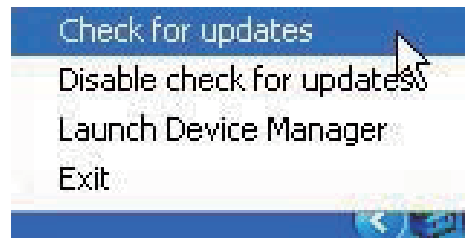

- ↳ **Philips SA4RGAXX Device Manager** checks for updates from the Internet.

Update the firmware

- 1** When the firmware update is available, follow the onscreen instructions to download and install the firmware.
- 2** Disconnect **RAGA** from the PC.
 - ↳ **RAGA** restarts after the firmware is updated and is ready for use again,

9 Troubleshooting

If **RAGA** is not working properly or the display freezes, you can reset it without losing data:

How do I reset RAGA?

- Insert a pen tip or other object into the reset hole on **RAGA**. Hold until the player shuts down.
- If the reset option is unsuccessful, recover **RAGA** through **Philips Device Manager**:

- 1 On your PC, launch **Philips Device Manager**.
- 2 Enter the recovery mode:
 - ① Switch off **RAGA**.
 - ② Press and hold the volume button , and then, connect **RAGA** to your PC.
 - ③ Keep holding the button until **Philips Device Manager** recognizes **RAGA** and enters the recovery mode.
- 3 Start the recovery process:
 - ① On **Philips Device Manager**, click the **Repair** button. Follow the onscreen instructions to complete the recovery process.
 - ② When the recovery is completed, disconnect **RAGA** from your PC.
- 4 Restart **RAGA**.

10 Technical data

Power

- Power supply: 220 mAh Li-ion polymer internal rechargeable battery
- Play time¹
Audio (.mp3): up to 22 hours
Radio: up to 8 hours

Software

- **Philips Device Manager:** To update the firmware and recover the player
- **Songbird:** To transfer³ media

Connectivity

- Headphone 3.5 mm
- USB 2.0 High speed

Sound

- Channel separation: 45 dB
- Frequency Response: 20-18,000 Hz
- Output power: 2 x 2.4 mW
- Signal to noise ratio: > 84 dB

Audio playback

Supported formats:

- MP3
Bitrate: 8-320 kbps and VBR
Sampling rates: 8, 11.025, 16, 22.050, 32, 44.1, 48 kHz
- WMA (unprotected)
Bitrate: 10-320 kbps CBR, 32-192 kbps VBR
Sampling rates: 8, 11.025, 16, 22.050, 32, 44.1, 48 kHz
- WAV

Storage media

Built-in memory capacity²:

- SA4RGA02 2 GB NAND Flash
- SA4RGA04 4 GB NAND Flash
- SA4RGA08 8 GB NAND Flash

Media transfer³

- Songbird (sync)
- Windows Explorer (drag and drop)

Display

- Color LCD 128 x 64 pixels

Note

- Specifications are subject to change without notice.
- ¹ Rechargeable batteries have a limited number of charge cycles. Battery life and number of charge cycles vary by use and settings.
- ² 1 GB = 1 billion bytes; available storage capacity is less. Full memory capacity may not be available as some memory is reserved for the player. Storage capacity is based on 4 minutes per song and 128-kbps MP3 encoding.
- ³ Transfer speed depends on operating system and software configuration.

PC requirements

- Windows® XP (SP3 or above) / Vista / 7 / 8
- Pentium III 800 MHz processor or higher
- 512 MB RAM
- 500 MB hard disk space
- Internet connection
- Windows® Internet Explorer 6.0 or later
- USB port

