

Register your product and get support at

www.philips.com/welcome

GoGEAR

SA4MIN02

SA4MIN04



User manual

PHILIPS

Contents

1	Important safety information	4
	General maintenance	4

2	Your new player	6
	What's in the box	6
	PC software loaded on the player	6
	Files loaded on the player	6
	Overview	6
	Controls	6
	Home screen	7
	Screen on/off	7

3	Get started	8
	Charge power	8
	Switch the player on or off	8

4	Music	9
	Transfer your PC music library to the player	9
	Organize music files on a PC	9
	Find music on the player	9
	Find music by song information	9
	Find music by file folder	9
	Play music	9
	Select play options	10

5	FM radio	11
	Tune in to radio stations	11
	Store preset stations	11

6	Recordings	12
	Record audio/voices	12
	Record from the FM radio	12
	Listen to recordings	12

7	Folder view	13
----------	--------------------	-----------

8	Settings	14
	Backlight	14
	Language	14
	Version	14
	Reset	14

9	Update the firmware through Philips Device Manager	15
----------	---	-----------

10	Troubleshooting	17
-----------	------------------------	-----------

11	Technical data	18
	PC requirements	18

Need help?

Please visit www.philips.com/welcome where you can access a full set of supporting materials such as user manual, the latest software updates and answers to frequently asked questions.

1 Important safety information

General maintenance

The translation of this document is for reference only.

In the event of any inconsistency between the English version and the translated version, the English version shall prevail.

! Caution

- To avoid damage or malfunction:
- Do not expose the product to excessive heat caused by heating equipment or direct sunlight.
- Do not drop the product or allow objects to fall on your player.
- Do not allow the product to be submerged in water. Do not expose headphone socket or battery compartment to water; as water entering the set may cause major damage.
- Active mobile phones in the vicinity may cause interference.
- Back up your files. Ensure that you retain the original files you have downloaded to your device. Philips is not responsible for any loss of data if the product becomes damaged or not readable / legible.
- Manage (transfer, delete, etc.) your music files only with the supplied music software to avoid problems.
- Do not use any cleaning agents containing alcohol, ammonia, benzene, or abrasives as these may harm the product.

About operating and storage temperatures

- Operate in a place where temperature is always between 0 and 35°C (32 to 95°F)
- Store in a place where temperature is always between 20 and 45°C (4 to 113°F).
- Battery life may be shortened in low temperature conditions.

Replacement parts/accessories:

Visit www.philips.com/support to order replacement parts/accessories.

Hearing Safety



The maximum output voltage of the player is not greater than 150 mV.

Listen at a moderate volume:

Using headphones at a high volume can impair your hearing. This product can produce sounds in decibel ranges that may cause hearing loss for a normal person, even for exposure less than a minute. The higher decibel ranges are offered for those that may have already experienced some hearing loss.

Sound can be deceiving. Over time your hearing 'comfort level' adapts to higher volumes of sound. So after prolonged listening, what sounds 'normal' can actually be loud and harmful to your hearing. To guard against this, set your volume to a safe level before your hearing adapts and leave it there.

To establish a safe volume level:

Set your volume control at a low setting.

Slowly increase the sound until you can hear it comfortably and clearly, without distortion.

Listen for reasonable periods of time:

Prolonged exposure to sound, even at normally 'safe' levels, can also cause hearing loss.

Be sure to use your equipment reasonably and take appropriate breaks.

Be sure to observe the following guidelines when using your headphones.

Listen at reasonable volumes for reasonable periods of time.

Be careful not to adjust the volume as your hearing adapts.

Do not turn up the volume so high that you can't hear what's around you.

You should use caution or temporarily discontinue use in potentially hazardous situations.

Do not use headphones while operating a motorized vehicle, cycling, skateboarding, etc.; it may create a traffic hazard and is illegal in many areas.

Modifications

Modifications not authorized by the manufacturer may void user's authority to operate the product.

Copyright information

All other brands and product names are trademarks of their respective companies or organizations.

Unauthorized duplication of any recordings whether downloaded from the Internet or made from audio CDs is a violation of copyright laws and international treaties.

The making of unauthorized copies of copy protected material, including computer programs, files, broadcasts and sound recordings, may be an infringement of copyrights and constitute a criminal offense. This equipment should not be used for such purposes.

The Windows Media and the Windows logo are registered trademarks of Microsoft Corporation in the United States and/or other countries.

Be responsible! Respect copyrights.



Philips respects the intellectual property of others, and we ask our users to do the same. Multimedia content on the internet may have been created and/or distributed without the original copyright owner's authorization.

Copying or distributing unauthorized content may violate copyright laws in various countries including yours.

Compliance with copyright laws remains your responsibility.

The recording and transfer to the portable player of video streams downloaded to your computer is intended only for use with public domain or properly licensed content. You may only use such content for your private, non commercial use and shall respect eventual copyright instructions provided by the copyright owner of the work. Such instruction may state that no further copies shall be made. Video streams may include copy protection technology that prohibits further copying. For such situations the recording function will not work and you will be notified with a message.

Data logging

Philips is committed to improving the quality of your product and enhancing the Philips user experience. To understand the usage profile of this device, this device logs some info / data to the non volatile memory region of the device. These data are used to identify and detect any failures or problems you as a user may experience while using the device. The data stored, for example, will be the duration of playback in music mode, duration of playback in tuner mode, how many times battery low was encountered, etc. The data stored do not reveal the content or media used on the device or the source of downloads. The data stored on the device are retrieved and used ONLY if the user returns the device to the Philips service center and ONLY to simplify error detection and prevention. The data stored shall be made available to user on user's first request.

2 Your new player

What's in the box

Make sure that you have received the following items:

Player



Earphones

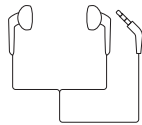

Quick start guide



Safety and Warranty sheet



Note

- The images serve as reference only. Philips reserves the right to change color/design without notice.

PC software loaded on the player

MINI comes with the following PC software:

- Philips Device Manager (helps you get firmware updates for MINI)

To get Philips Device Manager online,

- On your PC, go to www.philips.com/support.

Files loaded on the player

The following files are loaded on MINI:

- User manual
- Frequently asked questions

Overview

Controls

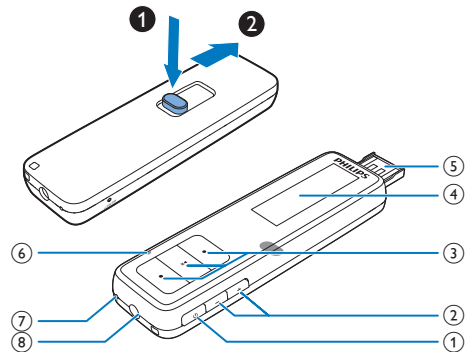

- ①
 - Press and hold: Switch the player on or off
 - Press: Go back one level, or exit
- ②
 - Press: Increase/decrease the volume
 - Press and hold: Increase/decrease the volume quickly

- ③ ● / ● ●
- **on the list of options:**
Press: Skip to the previous/next option
 - **on the play screen:**
Press: Skip to the next/previous option
Press and hold: Fast forward/rewind within current file
- ▶||
- Press: Select options, or start/pause/resume play
Press and hold: Show the options menu

④ Display

⑤ USB connector for power charging and data transfer

⑥ RESET

- Press the hole by using the tip of a ball pen when the screen does not respond to the pressing of keys

⑦ MIC

- Microphone

⑧ 🎧

- 3.5 mm headphone connector

Home screen

Mode	To
🎵	play audio files
🎤	make voice recordings
📻	tune in to the FM radio; record from the FM radio
📁	view files in folders
⚙️	customize the settings of MINI

Navigate from the Home screen

- From the Home screen, you can access functional menus by pressing the navigation buttons ● / ● ● and ▶||.
- Press 🏠 to go back one level or exit.

Screen on/off

To save power, the screen switches off automatically after the pre defined time duration if

- no new action is taken on **MINI**.

To select the time duration

- Go to [Settings] > [Backlight].

To exit the power saving mode

- Press any key.

3 Get started

Switch the player on or off

Press and hold  until the player is switched on or off.

Charge power

MINI has a built in battery that can be charged through the USB port of a computer:

- 1 Slide out the USB connector:
 - ① Press the button to unlock the USB connector.
 - ② Slide out the USB connector.

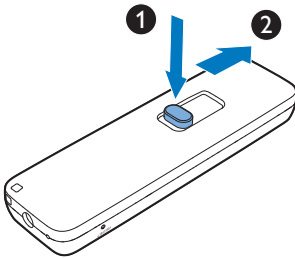

- 2 Connect MINI to a PC
↳ You enter the transfer mode.

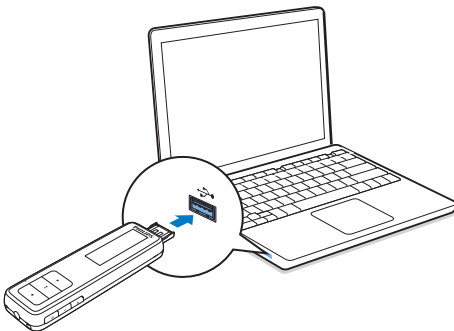

4 Music

Transfer your PC music library to the player

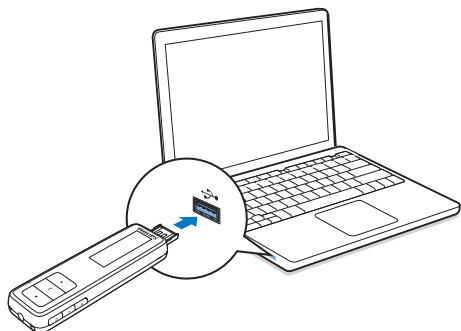

You can transfer music from your PC media library to **MINI** in the following way:

- Drag and drop music files in Windows Explorer.
By doing so, you can organize your music collection by file folder.

To drag and drop music files in Windows Explorer,

- 1 Connect **MINI** to a PC.
↳ You enter the transfer mode.
- 2 On the PC, under **My Computer** or **Computer**,
 - Find **MINI**;
 - Find the desired music files/folders.
- 3 From the PC, drag and drop music files/folders to **MINI**.

Organize music files on a PC

Organize music files by song information

If the files contain song information (meta data or ID3 tag), the files can be sorted automatically by the song information on **MINI**.

Launch media management software to check or edit the file information, for example,

Windows Media Player 11.

Organize music files by file folder

You can also organize music files in different folders as needed.

Find music on the player

Find music by song information

From the Home screen, go to **♪** to find music by song title (meta data or ID3 tag) in different folders.

Find music by file folder

- From the Home screen, go to **■** to find music by file folder.
- In **♪**, press and hold **▶||**. Press **●** / **●** / **●** and **▶||** to select [**Local folder**].

Play music

- 1 Press **●** / **●** / **●** to select a music file.
- 2 Press **▶||** to start play.
↳ Play starts from current song.
↳ On the play screen, you can see the file information and play status.
- 3 During playback,
 - Press **▶||** to pause and resume play.

To select a music file on the play screen

- Repeatedly press **●** / **●** / **●**.

To rewind or fast forward within current song

- On the play screen, press and hold **●** / **●** or **●** / **●**.

Select play options

During music play, press and hold **▶||** to select play options.

[Repeat]

- **[Normal]**: Plays all the songs in sequence.
- **[Repeat One]**: Repeats current song.
- **[Repeat All]**: Repeats all songs.
- **[Shuffle]**: Plays all songs in random order.
- **[Intro]**: Plays each song in current folder for 10 seconds.

[Equalizer]

- Select pre defined sound settings.

5 FM radio







Note

- Plug in the supplied earphones when you tune in to radio stations. The earphones double as antenna. For better reception, move the earphone cable in different directions.

Tune in to radio stations

Auto tune

The first time you tune in to the radio, start Auto search to search for stations.







- 1 In , press and hold . Then, press  /   and  to select **[Auto Search]**.
↳ Available stations are stored as presets.
- 2 Press  repeatedly to select a preset station.

Tip





- When you move to a new place (such as a new city or country), restart auto tune for better reception.

Manual tune





Use Manual tune to search for a frequency or station.

- On the play screen, press and hold  /  or .
↳ You tune in to the next station from current frequency.
- For fine tuning, press  /  or  repeatedly.





Store preset stations

- 1 Tune in to a radio station.
- 2 On the radio play screen, press and hold . Then, press  /   and  to select **[Save]**.
↳ Current station is stored as a preset.

To remove current preset station

- On the radio play screen, press and hold . Then, press  /   and  to select **[Delete]**.

To remove all preset stations



- On the radio play screen, press and hold . Then, press  /   and  to select **[Delete all]**.

6 Recordings

Record audio/voices

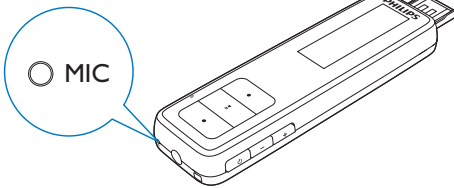
- 1 From the Home screen, select .
↳ The recording screen is displayed.
- 2 Make sure that the microphone is close to the sound source to be recorded.









- 3 Press  to record or pause.
- 4 Press  to save the recording.
↳ Recordings are saved on the player.
(Filename format: RECXXX, where XXX is the recording number that is generated automatically.)

 **Tip**

- Go the Home screen. You can find your recordings under .





Record from the FM radio

- 1 Tune in to a radio station.
- 2 On the radio play screen, press and hold . Then, press  /  and  to select **[Record]**.
↳ You start recording from the FM radio.
- 3 Press  to record or pause.
- 4 Press  to save the recording.
↳ Recordings are saved on the player:
(Filename format: RECXXX, where XXX is the recording number that is generated automatically.)

 **Tip**

- Go the Home screen. You can find your recordings under .

Listen to recordings

- 1 From the Home screen, select .
- 2 Press  or  to select a recording.
- 3 Press  to start play.
- 4 On the play screen, press and hold  to select play options.

7 Folder view

Go to ■ to view and play the music files that are stored on the player:

RECORD: for voice and FM radio recordings that you make on the player.

To find files that you have transferred in Windows Explorer,

- Locate the files as you have organized in Windows Explorer on the PC.

8 Settings

In **[Settings]**, select your options for the player:

- 1 Press ● / ● ● to select an option.
- 2 Press ►|| to confirm.

Backlight

The screen enters the idle mode, if no new action is taken on **MINI**. After the pre defined time duration, the idle screen is switched off automatically. To save battery power, select a low value for the time duration.

To set the time duration

- In **[Backlight]**, select a time duration.
 - ↳ After the selected time duration, the idle screen is switched off automatically.

To exit the power saving mode

- Press any key.

Language

In **[Language]**, select a language for the player:

Version

In **[version]**, check the firmware version when you update firmware from the support website.

Reset

In **[Reset]**, restore the player to factory settings. Files transferred to the player are retained.

9 Update the firmware through Philips Device Manager

Install Philips Device Manager

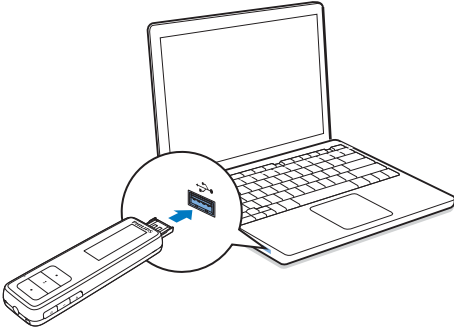

- 1 Connect **MINI** to a PC.
- 2 On the PC, select **My Computer** (Windows XP / Windows 2000) / **Computer** (Windows Vista / Windows 7).
- 3 Click the **Philips GoGEAR MINI** icon. Double click the **installer.exe**.
- 4 Follow the onscreen instructions to complete the installation of the software.

Note

- The installation requires you to agree to the license terms.

Check for firmware updates

- 1 Make sure that you have connected your PC to the Internet.
- 2 Launch **Philips Device Manager**.
↳ A dialog box is displayed.
- 3 Connect **MINI** to your PC.

- ↳ When the device is connected, "SA4MINXX" is displayed on the text box.
- ↳ You can find current firmware version of the device.

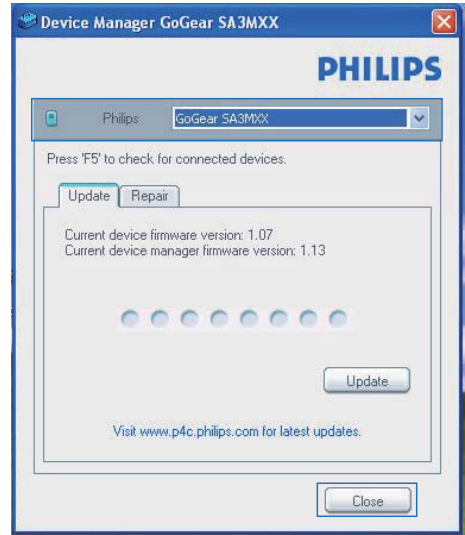

- 4 To check for firmware updates,
 - ① Close the dialog box of Philips Device Manager.
 - ② At the base of the PC screen, right click  and select Check for updates.

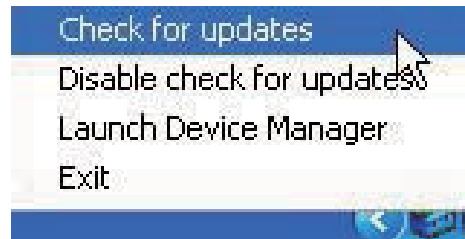

- ↳ Philips SA4MINXX Device Manager checks for updates from the Internet.

Update the firmware

- 1 When the firmware update is available, follow the onscreen instructions to download and install the firmware.
- 2 Disconnect **MINI** from the PC.
 - ↳ **MINI** restarts after the firmware is updated and is ready for use again,

10 Troubleshooting

If MINI is not working properly or the display freezes, you can reset it without losing data:

How do I reset MINI?

- Insert a pen tip or other object into the reset hole located at the bottom of MINI. Hold until the player shuts down.
- If the reset option is unsuccessful, follow the steps how to recover MINI with the **Philips Device Manager**:

- 1** On your computer, select **Start > Programs > Philips > Philips MP3 player > GoGear SA4MINXX Device Manager** to launch the **Philips Device Manager**.
- 2** Turn off MINI before you continue.
- 3** Press and hold the volume button **+** while you connect MINI to your computer.
- 4** Keep holding the key until the **Philips Device Manager** acknowledges MINI and enters the recovery mode.
- 5** On the computer, click the **Repair** button and follow the instructions of the **Philips Device Manager** to complete the recovery process.
- 6** When the recovery is completed, disconnect MINI from your computer.
- 7** Restart MINI.

11 Technical data

Power

- Power supply: 95 mAh Li ion polymer internal rechargeable battery
- Play time¹
Audio (.mp3): up to 8 hours
Radio: up to 3.5 hours

Software

- Philips Device Manager

Connectivity

- Headphone 3.5 mm
- USB 2.0 High speed

Sound

- Channel separation: 40 dB
- Frequency Response: 20 20,000 Hz
- Output power: 10.0 mW
- Signal to noise ratio: > 85 dB

Audio playback

Supported formats:

- MP3
Bitrate: 8 320 kbps
- WMA (unprotected)
Bitrate: 5 192 kbps
- WAV

Storage media

Built in memory capacity²:

- SA4MIN02 2 GB NAND Flash
- SA4MIN04 4 GB NAND Flash

Media transfer³

- Windows Explorer (drag and drop)

Display

- LCD 128 x 64 pixels

PC requirements

- Windows® XP (SP3 or above) / Vista / 7
- Pentium III 800 MHz processor or higher
- 512 MB RAM
- 500 MB hard disk space
- Internet connection
- Windows® Internet Explorer 6.0 or later
- CD ROM drive
- USB port



Note

- Specifications are subject to change without notice.
- ¹ Rechargeable batteries have a limited number of charge cycles. Battery life and number of charge cycles vary by use and settings.
- ² 1GB = 1 billion bytes; available storage capacity is less.
Full memory capacity may not be available as some memory is reserved for the player. Storage capacity is based on 4 minutes per song and 128 kbps MP3 encoding.
- ³ Transfer speed depends on operating system and software configuration.

