

Always there to help you

Register your product and get support at
www.philips.com/support



GoGEAR

SA4DOT02

SA4DOT04

SA4DOT08



User manual

PHILIPS

Contents

1	Important safety information	2
	General maintenance	2

2	Your new player	5
	What's in the box	5
	PC software for the player	5
	Files loaded on the player	5
	Overview	5
	Controls	5
	LED indicator and audio feedback	6

3	Get started	7
	Charge power	7
	Switch the player on or off	7
	Automatic standby and shut-down	7

4	Play music	8
	Transfer music to the player	8
	Play music	8
	Search for a song	8
	Change the volume level	8
	Switch the random play on or off	8

5	Update the firmware through Philips Device Manager	9
----------	---	----------

6	Troubleshooting	11
----------	------------------------	-----------

7	Technical data	12
	PC requirements	12

Need help?

Please visit

www.philips.com/support

where you can access a full set of supporting materials such as the user manual, the latest software updates, and answers to frequently asked questions.

1 Important safety information

General maintenance

The translation of this document is for reference only.

In the event of any inconsistency between the English version and the translated version, the English version shall prevail.

! Caution

- To avoid damage or malfunction:
- Use only power supplies listed in the user manual.
- Do not expose the product to excessive heat caused by heating equipment or direct sunlight.
- Do not drop the product or allow objects to fall on your player.
- Do not allow the product to be submerged in water. Do not expose headphone socket or battery compartment to water; as water entering the set may cause major damage.
- Active mobile phones in the vicinity may cause interference.
- Back up your files. Ensure that you retain the original files you have downloaded to your device. Philips is not responsible for any loss of data if the product becomes damaged or not readable / legible.
- Manage (transfer, delete, etc.) your music files only with the supplied music software to avoid problems.
- Do not use any cleaning agents containing alcohol, ammonia, benzene, or abrasives as these may harm the product.
- Batteries (battery pack or batteries installed) shall not be exposed to excessive heat such as sunshine, fire or the like.
- Danger of explosion if battery is incorrectly replaced. Replace only with the same or equivalent type.

About operating and storage temperatures

- Operate in a place where temperature is always between 0 and 45°C (32 to 113°F)

- Store in a place where temperature is always between -20 and 45°C (-4 to 113°F).
- Battery life may be shortened in low temperature conditions.

Replacement parts/accessories:

Visit www.philips.com/support to order replacement parts/accessories.

Hearing Safety



Listen at a moderate volume:

Using headphones at a high volume can impair your hearing. This product can produce sounds in decibel ranges that may cause hearing loss for a normal person, even for exposure less than a minute. The higher decibel ranges are offered for those that may have already experienced some hearing loss.

Sound can be deceiving. Over time your hearing 'comfort level' adapts to higher volumes of sound. So after prolonged listening, what sounds 'normal' can actually be loud and harmful to your hearing. To guard against this, set your volume to a safe level before your hearing adapts and leave it there.

To establish a safe volume level:

Set your volume control at a low setting.

Slowly increase the sound until you can hear it comfortably and clearly, without distortion.

Listen for reasonable periods of time:

Prolonged exposure to sound, even at normally 'safe' levels, can also cause hearing loss.

Be sure to use your equipment reasonably and take appropriate breaks.

Be sure to observe the following guidelines when using your headphones.

Listen at reasonable volumes for reasonable periods of time.

Be careful not to adjust the volume as your hearing adapts.

Do not turn up the volume so high that you can't hear what's around you.

You should use caution or temporarily discontinue use in potentially hazardous situations.

Do not use headphones while operating a motorized vehicle, cycling, skateboarding, etc.; it may create a traffic hazard and is illegal in many areas.

Modifications

Modifications not authorized by the manufacturer may void user's authority to operate the product.

Copyright information

All other brands and product names are trademarks of their respective companies or organizations.

Unauthorized duplication of any recordings whether downloaded from the Internet or made from audio CDs is a violation of copyright laws and international treaties.

The making of unauthorized copies of copy-protected material, including computer programs, files, broadcasts and sound recordings, may be an infringement of copyrights and constitute a criminal offense. This equipment should not be used for such purposes.

The Windows Media and the Windows logo are registered trademarks of Microsoft Corporation in the United States and/or other countries.

Be responsible! Respect copyrights.



Philips respects the intellectual property of others, and we ask our users to do the same. Multimedia content on the internet may have been created and/or distributed without the original copyright owner's authorization. Copying or distributing unauthorized content may violate copyright laws in various countries including yours.

Compliance with copyright laws remains your responsibility.

The recording and transfer to the portable player of video streams downloaded to your computer is intended only for use with public domain or properly licensed content. You may only use such content for your private, non-commercial use and shall respect eventual copyright instructions provided by the copyright owner of the work. Such instruction may state that no further copies shall be made. Video streams may include copy protection technology that prohibits further copying. For such situations the recording function will not work and you will be notified with a message.

Data logging

Philips is committed to improving the quality of your product and enhancing the Philips user experience. To understand the usage profile of this device, this device logs some info / data to the non-volatile memory region of the device. These data are used to identify and detect any failures or problems you as a user may experience while using the device. The data stored, for example, will be the duration of playback in music mode, duration of playback in tuner mode, how many times battery low was encountered, etc. The data stored do not reveal the content or media used on the device or the source of downloads. The data stored on the device are retrieved and used ONLY if the user returns the device to the service center and ONLY to simplify error detection and prevention. The data stored shall be made available to user on user's first request.



Your product is designed and manufactured with high quality materials and components, which can be recycled and reused. Please inform yourself about the local rules on separate collection of batteries because correct disposal helps to prevent negative

consequences for the environmental and human health.

2 Your new player

What's in the box

Make sure that you have received the following items:

Player

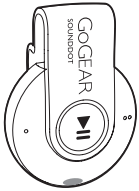

Earphones

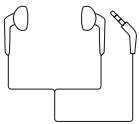

Quick start guide



Safety and Warranty sheet



Note

- The images serve as reference only. Philips reserves the right to change color/design without notice.

PC software for the player

SOUND DOT can work with the following PC software:

- Philips Device Manager** (helps you get firmware updates and recover the player)

Files loaded on the player

The following files are loaded on SOUND DOT:

- User manual
- Frequently asked questions

Overview

Controls

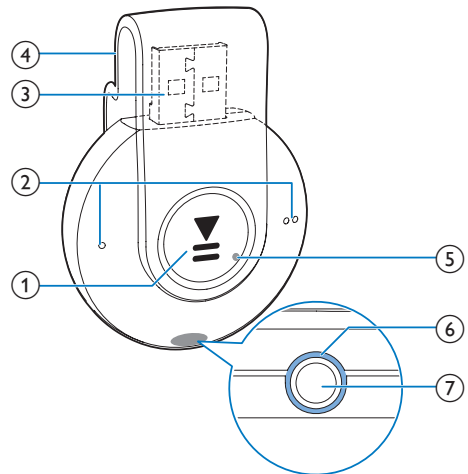

- 1** **1**
 - Press and hold: Switch the player on or off
 - Press: Pause/ resume play
 - Press twice during play: Switch the random play on or off
- 2** **2**
 - Press: Decrease or increase the volume
 - Press and hold: Skip to the previous or next song

- ③ USB connector for power charging and data transfer
- ④ Clip
- ⑤ RESET
 - Press the hole by using the tip of a ball pen when the player does not respond to the pressing of keys
- ⑥ LED indicator
- ⑦  3.5 mm-headphone connector
 - 3.5 mm-headphone connector

LED indicator and audio feedback

With the LED indicator and/ or audio feedback, you can know the status of the player.

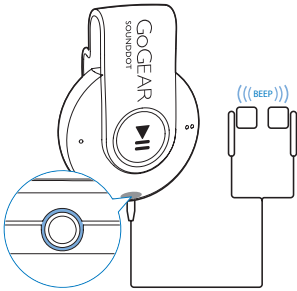

3 Get started

- ↳ **Power on:** The green indicator lights up. Music play starts.
- ↳ **Power off:** The red indicator lights up. One beep sounds.

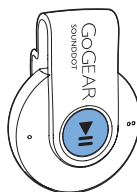

Charge power

SOUND DOT has a built-in battery that can be charged through the USB socket of a computer.

- Rotate the USB connector to connect **SOUND DOT** to a PC.
 - ↳ During power charging, the indicator changes its color to denote the battery level.
 - ↳ When the battery is full, the green indicator lights up.

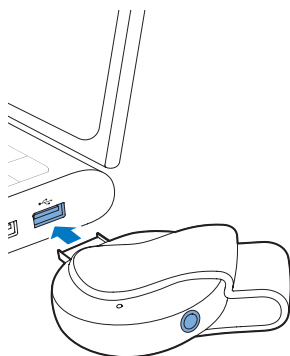

Automatic standby and shut-down

The player has an automatic standby and shut-down feature that can save battery power. After five minutes in idle mode (no play, no button is pressed), the player switches off.

Tip

- When the battery level is lower than 15%, the red indicator flashes and two beeps sound.
- Rechargeable batteries have a limited number of charge cycles. Battery life and number of charge cycles vary by use and settings.

Switch the player on or off

- Press and hold **▶||** until the green or red indicator lights up.

4 Play music

Transfer music to the player

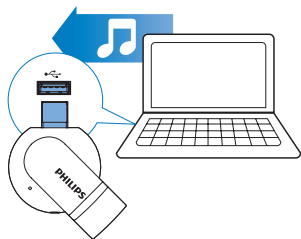

You can transfer music from your PC media library to **SOUNDSDOT** in the following ways:

- Drag and drop music files in Windows Explorer.

To drag and drop music files in Windows Explorer,

- 1 Connect **SOUNDSDOT** to a PC.
- 2 On the PC, under **My Computer** or **Computer**,
 - drag and drop music files from the PC to **SOUNDSDOT**.

Play music

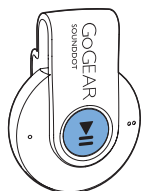

- 1 Make sure that you have switched on the player (see 'Switch the player on or off' on page 7).
 - ↳ The green indicator lights up. Music play starts.
 - ↳ During music play, the green indicator flashes at intervals.

- 2 Press **▶||** to pause or resume play.

Search for a song

- Press and hold **● / ● ●** to skip to the previous or next song.
 - ↳ One beep sounds.

Change the volume level

- Press **● / ● ●**.
 - ↳ During music play, you hear the change of volume level.

Switch the random play on or off

- 1 During music play, press **▶||** twice.
 - ↳ You hear two beeps. The green indicator flashes twice at intervals.
 - ↳ Songs play in random.
- 2 To switch off the random play, press **▶||** twice again.
 - ↳ You hear one beep. The green indicator flashes once at intervals.
 - ↳ Songs play in sequence.

5 Update the firmware through Philips Device Manager

Install Philips Device Manager

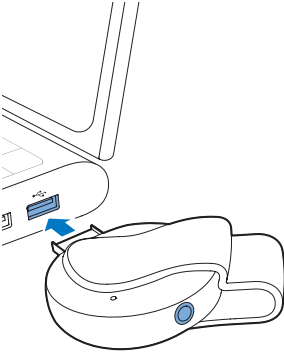

- 1 Connect **SOUND DOT** to a PC.
- 2 On the PC, select **My Computer** (Windows XP / Windows 2000) / **Computer** (Windows Vista / Windows 7 / 8).
- 3 Right click on the **Philips GoGear SOUND DOT** icon. Select **Install Philips Device Manager**.
 - Alternatively, click the **Philips GoGear SOUND DOT** icon. Double-click the **installer.exe**.
- 4 Follow the onscreen instructions to complete the installation of the software.

Note

- The installation requires you to agree to the license terms.

Check for firmware updates

- 1 Make sure that you have connected your PC to the Internet.
- 2 Launch **Philips Device Manager**.
 - ↳ A dialog box is displayed.
- 3 Connect **SOUND DOT** to your PC.
 - ↳ When the device is connected, "SA4DOTXX" is displayed on the text box.
 - ↳ You can find current firmware version of the device.

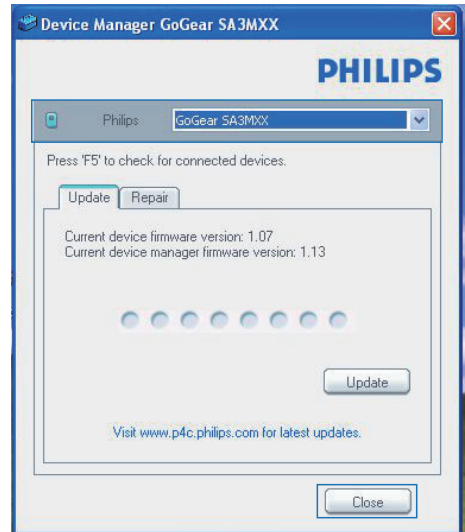

- 4 To check for firmware updates,
 - ① Close the dialog box of Philips Device Manager.
 - ② At the base of the PC screen, right click  and select **Check for updates**.

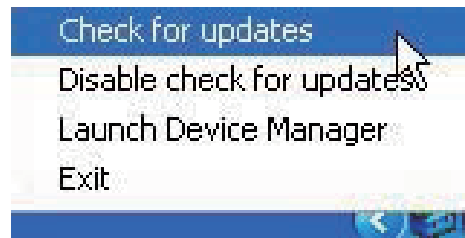

- ↳ **Philips SA4DOTXX Device Manager** checks for updates from the Internet.

Update the firmware

- 1** When the firmware update is available, follow the onscreen instructions to download and install the firmware.
- 2** Disconnect **SOUND DOT** from the PC.
 - ↳ **SOUND DOT** restarts after the firmware is updated and is ready for use again,

6 Troubleshooting



If **SOUND DOT** is not working properly or the display freezes, you can reset it without losing data:

How do I reset **SOUND DOT**?

- Insert a pen tip or other object into the reset hole on **SOUND DOT**. Hold until the player shuts down.
- If the reset option is unsuccessful, recover **SOUND DOT** through **Philips Device Manager**:

1 On your PC, launch **Philips Device Manager**.

2 Enter the recovery mode:

- ① Switch off **SOUND DOT**.
- ② Press and hold the volume button  , and then, connect **SOUND DOT** to your PC.
- ③ Keep holding the button until **Philips Device Manager** recognizes **SOUND DOT** and enters the recovery mode.

3 Start the recovery process:

- ① On **Philips Device Manager**, click the **Repair** button. Follow the onscreen instructions to complete the recovery process.
- ② When the recovery is completed, disconnect **SOUND DOT** from your PC.

4 Restart **SOUND DOT**.

7 Technical data

Power

- Power supply: 110 mAh Li-ion polymer internal rechargeable battery
- Play time¹
Audio (.mp3): up to 6 hours
- Fast charging: 6-minute charging for 60-minute play

Software

- **Philips Device Manager:** To update the firmware and recover the player

Connectivity

- Headphone 3.5 mm
- USB 2.0 High speed

Sound

- Channel separation: 45 dB
- Frequency Response: 20-18,000 Hz
- Output power: 2 x 2.4 mW
- Signal to noise ratio: > 84 dB

Audio playback

Supported formats:

- MP3
Bitrate: 8-320 kbps and VBR
Sampling rates: 8, 11.025, 16, 22.050, 32, 44.1, 48 kHz
- WMA (unprotected)
Bitrate: 5-320 kbps
Sampling rates: 8, 11.025, 16, 22.050, 32, 44.1, 48 kHz
- WAV

Storage media

Built-in memory capacity²:

- SA4DOT02 2 GB NAND Flash
- SA4DOT04 4 GB NAND Flash
- SA4DOT08 8 GB NAND Flash

Media transfer³

- Windows Explorer (drag and drop)

Note

- Specifications are subject to change without notice.
- ¹ Rechargeable batteries have a limited number of charge cycles. Battery life and number of charge cycles vary by use and settings.
- ² 1 GB = 1 billion bytes; available storage capacity is less. Full memory capacity may not be available as some memory is reserved for the player. Storage capacity is based on 4 minutes per song and 128-kbps MP3 encoding.
- ³ Transfer speed depends on operating system and software configuration.

PC requirements

- Windows® XP (SP3 or above) / Vista / 7
- Pentium III 800 MHz processor or higher
- 512 MB RAM
- 500 MB hard disk space
- Internet connection
- Windows® Internet Explorer 6.0 or later
- CD-ROM drive
- USB port



2015 © Gibson Innovations Limited. All rights reserved.
This product has been manufactured by, and is sold under the
responsibility of Gibson Innovations Ltd., and Gibson Innovations Ltd.
is the warrantor in relation to this product.
Philips and the Philips Shield Emblem are registered trademarks of
Koninklijke Philips N.V. and are used under license from Koninklijke
Philips N.V.