

Register your product and get support at
www.philips.com/welcome

GoGear



SA3MXX02

SA3MXX04

SA3MXX08

FM radio

✓	✗
K/02	KN/02
W/02	WN/02
A/93	
B/93	
K/93	
P/93	
K/97	
W/97	

EN User manual

PHILIPS

Contents

1	Important safety information	4
	General maintenance	4
	Recycling the product	6

2	Your new player	8
	What's in the box	8
	Software loaded on the player	8
	Files loaded on the player	8

3	Get started	9
	Charge power	9
	First-time setup	9
	Switch the player on or off	10
	Automatic standby and shut-down	10

4	Overview	11
	Controls	11
	Home screen	12
	Lock/unlock the keys	12
	Screen on/off	12

5	Music	13
	Manage music on PC	13
	Organize your music files	13
	Transfer files in Windows Explorer	13
	Add or delete music files	13
	Find music on the player	13
	Find music by song information	13
	Find music by file folder	13
	Play music	14

6	FM radio	15
	Tune in to radio stations	15
	Listen to the FM radio	15
	Store preset stations	15

7	Recordings	16
	Record audio/voices	16
	Listen to recordings	16
	Delete one or more recordings	16
	Upload your recordings to a computer	16

8	Settings	17
	Play mode	17
	Sound settings	17
	Display settings	17
	Theme	17
	Screen off timer	17
	Rotate screen	17
	Language	17
	Information	18
	Factory settings	18

9	Update MIX	19
	Manually verify/ update firmware	19

10	Troubleshooting	20
-----------	------------------------	-----------

11	Technical data	21
	System requirements	21

Need help?

Please visit

www.philips.com/welcome

where you can access a full set of supporting materials such as the user manual, the latest software updates, and answers to frequently asked questions.

1 Important safety information

General maintenance

The translation of this document is for reference only.

In the event of any inconsistency between the English version and the translated version, the English version shall prevail.

Caution

- To avoid damage or malfunction:
- Do not expose the product to excessive heat caused by heating equipment or direct sunlight.
- Do not drop the product or allow objects to fall on your player.
- Do not allow the product to be submerged in water. Do not expose headphone socket or battery compartment to water; as water entering the set may cause major damage.
- Active mobile phones in the vicinity may cause interference.
- Back up your files. Ensure that you retain the original files you have downloaded to your device. Philips is not responsible for any loss of data if the product becomes damaged or not readable / legible.
- Manage (transfer, delete, etc.) your music files only with the supplied music software to avoid problems.
- Do not use any cleaning agents containing alcohol, ammonia, benzene, or abrasives as these may harm the product.

About operating and storage temperatures

- Operate in a place where temperature is always between 0 and 35°C (32 to 95°F)
- Store in a place where temperature is always between -20 and 45°C (-4 to 113°F).
- Battery life may be shortened in low temperature conditions.

Replacement parts/accessories:

Visit www.philips.com/support to order replacement parts/accessories.

Hearing Safety



Listen at a moderate volume:

Using headphones at a high volume can impair your hearing. This product can produce sounds in decibel ranges that may cause hearing loss for a normal person, even for exposure less than a minute. The higher decibel ranges are offered for those that may have already experienced some hearing loss.

Sound can be deceiving. Over time your hearing 'comfort level' adapts to higher volumes of sound. So after prolonged listening, what sounds 'normal' can actually be loud and harmful to your hearing. To guard against this, set your volume to a safe level before your hearing adapts and leave it there.

To establish a safe volume level:

Set your volume control at a low setting.

Slowly increase the sound until you can hear it comfortably and clearly, without distortion.

Listen for reasonable periods of time:

Prolonged exposure to sound, even at normally 'safe' levels, can also cause hearing loss.

Be sure to use your equipment reasonably and take appropriate breaks.

Be sure to observe the following guidelines when using your headphones.

Listen at reasonable volumes for reasonable periods of time.

Be careful not to adjust the volume as your hearing adapts.

Do not turn up the volume so high that you can't hear what's around you.

You should use caution or temporarily discontinue use in potentially hazardous situations.

Do not use headphones while operating a motorized vehicle, cycling, skateboarding, etc.; it may create a traffic hazard and is illegal in many areas.

Modifications

Modifications not authorized by the manufacturer may void user's authority to operate the product.

Copyright information

All other brands and product names are trademarks of their respective companies or organizations.

Unauthorized duplication of any recordings whether downloaded from the Internet or made from audio CDs is a violation of copyright laws and international treaties.

The making of unauthorized copies of copy-protected material, including computer programs, files, broadcasts and sound recordings, may be an infringement of copyrights and constitute a criminal offense. This equipment should not be used for such purposes.

The Windows Media and the Windows logo are registered trademarks of Microsoft Corporation in the United States and/or other countries.

Be responsible! Respect copyrights.



**Be responsible
Respect copyrights**

Philips respects the intellectual property of others, and we ask our users to do the same. Multimedia content on the internet may have been created and/or distributed without the original copyright owner's authorization. Copying or distributing unauthorized content may violate copyright laws in various countries including yours.

Compliance with copyright laws remains your responsibility.

The recording and transfer to the portable player of video streams downloaded to your computer is intended only for use with public domain or properly licensed content. You may only use such content for your private, non-commercial use and shall respect eventual copyright instructions provided by the copyright

owner of the work. Such instruction may state that no further copies shall be made. Video streams may include copy protection technology that prohibits further copying. For such situations the recording function will not work and you will be notified with a message.

Data logging

Philips is committed to improving the quality of your product and enhancing the Philips user experience. To understand the usage profile of this device, this device logs some info / data to the non-volatile memory region of the device. These data are used to identify and detect any failures or problems you as a user may experience while using the device. The data stored, for example, will be the duration of playback in music mode, duration of playback in turner mode, how many times battery low was encountered, etc. The data stored do not reveal the content or media used on the device or the source of downloads. The data stored on the device are retrieved and used ONLY if the user returns the device to the Philips service center and ONLY to simplify error detection and prevention. The data stored shall be made available to user on user's first request.

Monkey's Audio decoder

- ① The Monkey's Audio SDK and source code can be freely used to add APE format playback, encoding, or tagging support to any product, free or commercial. Use of the code for proprietary efforts that don't support the official APE format require written consent of the author.
- ② Monkey's Audio source can be included in GPL and open-source software, although Monkey's Audio itself will not be subjected to external licensing requirements or other viral source restrictions.
- ③ Code changes and improvements must be contributed back to the Monkey's

Audio project free from restrictions or royalties, unless exempted by express written consent of the author.

- ④ Any source code, ideas, or libraries used must be plainly acknowledged in the software using the code.
- ⑤ Although the software has been tested thoroughly, the author is in no way responsible for damages due to bugs or misuse.

If you do not completely agree with all of the previous stipulations, you must cease using this source code and remove it from your storage device.

FLAC decoder

Copyright (C) 2000,2001,2002,2003,2004,2005, 2006,2007,2008,2009 Josh Coalson

Redistribution and use in source and binary forms, with or without modification, are permitted provided that the following conditions are met:

- Redistributions of source code must retain the above copyright notice, this list of conditions and the following disclaimer.
- Redistributions in binary form must reproduce the above copyright notice, this list of conditions and the following disclaimer in the documentation and/or other materials provided with the distribution.
- Neither the name of the Xiph.org Foundation nor the names of its contributors may be used to endorse or promote products derived from this software without specific prior written permission.

THIS SOFTWARE IS PROVIDED BY THE COPYRIGHT HOLDERS AND CONTRIBUTORS "AS IS" AND ANY EXPRESS OR IMPLIED WARRANTIES, INCLUDING, BUT NOT LIMITED TO, THE IMPLIED WARRANTIES OF MERCHANTABILITY AND FITNESS FOR A PARTICULAR PURPOSE

ARE DISCLAIMED. IN NO EVENT SHALL THE FOUNDATION OR CONTRIBUTORS BE LIABLE FOR ANY DIRECT, INDIRECT, INCIDENTAL, SPECIAL, EXEMPLARY, OR CONSEQUENTIAL DAMAGES (INCLUDING, BUT NOT LIMITED TO, PROCUREMENT OF SUBSTITUTE GOODS OR SERVICES; LOSS OF USE, DATA, OR PROFITS; OR BUSINESS INTERRUPTION) HOWEVER CAUSED AND ON ANY THEORY OF LIABILITY, WHETHER IN CONTRACT, STRICT LIABILITY, OR TORT (INCLUDING NEGLIGENCE OR OTHERWISE) ARISING IN ANY WAY OUT OF THE USE OF THIS SOFTWARE, EVEN IF ADVISED OF THE POSSIBILITY OF SUCH DAMAGE.

Recycling the product

Your product is designed and manufactured with high quality materials and components, which can be recycled and reused. When you see the crossed-out wheel bin symbol attached to a product, it means the product is covered by the European Directive 2002/96/EC:



Never dispose of your product with other household waste. Please inform yourself about the local rules on the separate collection of electrical and electronic products. The correct disposal of your old product helps prevent potentially negative consequences on the environment and human health.

Warning

- Removal of the built-in battery invalidates the warranty and can destroy the product.
- The following removal and disposal instructions are steps that are to be performed at the end of the product's life only.

Your product contains a built-in rechargeable battery covered by the European Directive 2006/66/EC, which cannot be disposed of with normal household waste.



To safeguard the functionality and safety of your product, take your product to an official collection point or service center where a professional can remove the battery as shown:

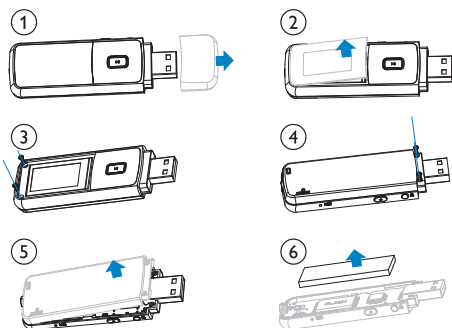

Please inform yourself about the local rules on separate collection of batteries. The correct disposal of batteries helps prevent potentially negative consequences on the environment and human health.

Notice for the European Union

This product complies with the radio interference requirements of the European Union.

2 Your new player

On **MIX**, you can do the following:

- Play music;
- Listen to the FM radio;
- Make voice recordings.

What's in the box

Check that you have received the following items:

Player

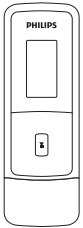

Earphones

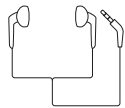

Quick start guide



Note

- The images serve as reference only. Philips reserves the right to change color/design without notice.

Software loaded on the player

MIX comes with the following software:

- Philips Device Manager (helps you get firmware updates for MIX)

Files loaded on the player

The following files are loaded on **MIX**:

- User manual
- Frequently asked questions

3 Get started

Charge power

MIX has a built-in battery that can be charged through the USB port of a computer. As shown, connect the MIX to a PC.

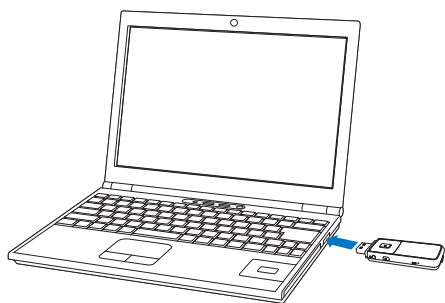





Note

- When you connect MIX to a computer, you are briefly prompted to select: [Charge & transfer] or [Charge & play].
- MIX automatically applies [Charge & transfer], if no new selection is made.

Battery level indication

The display indicates the approximate levels of the battery status as follows:

				
100%	75%	50%	25%	0%

- ↳ A flashing battery screen indicates that the battery is low. The player saves all settings and switches off within 60 seconds.

Note

- Rechargeable batteries have a limited number of charge cycles. Battery life and number of charge cycles vary by use and settings.
- The charging animation stops and the  icon is displayed when the charging process is completed.

To conserve battery power and increase the play time, do the following on MIX:

- Set the backlight timer to a low value (go to  > [Display settings] > [Screen off timer]).

First-time setup

The first time you connect MIX to a PC, install **Philips Device Manager** on the PC. Over the Internet, you can update the firmware of the player through **Philips Device Manager**. When you connect the MIX to the PC for the first time, a pop-up window appears:

- 1 Select **Install Philips Device Manager**.
- 2 Follow the on-screen instructions to complete the installation of the software.

Note

- The installation requires you to agree to the license terms.

If the pop-up window is not displayed automatically:

- 1 Select **My Computer** (Windows XP / Windows 2000) / **Computer** (Windows Vista / Windows 7).
- 2 Right click on the **Philips GoGear MIX** icon.
- 3 Select **Install Philips Device Manager**.
- 4 Follow the on-screen instructions to complete the installation of the software.

Note

- The installation requires you to agree to the license terms.

Switch the player on or off

Press and hold  until the player is switched on or off.

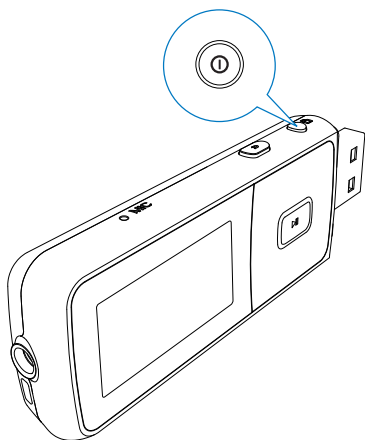

Automatic standby and shut-down

The player has an automatic standby and shut-down feature that can save battery power. After 10 minutes in idle mode (no play, no button is pressed), the player switches off.

4 Overview



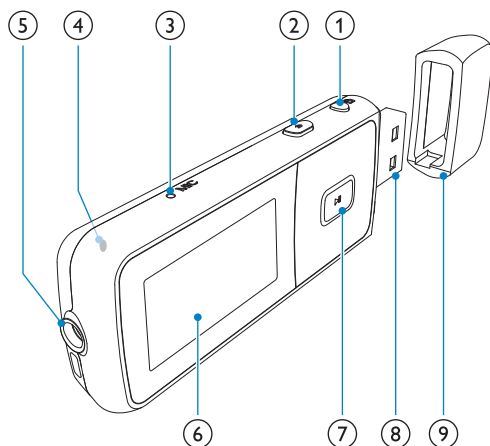



Controls







- ① press and hold: switch on/off the player
press: lock/unlock all buttons
- ② press: back one level
press and hold: return to the Home screen
- ③ **MIC** microphone
- ④ **RESET** press the hole by using the tip of a ball pen when the screen does not respond to the pressing of keys
- ⑤ 3.5 mm headphone connector
- ⑥ display

- ⑦ / **on the list of options:**
press: skip to the previous/next option
on the play screen:
press: increase/decrease the volume
press and hold: increase/decrease the volume quickly
- / **on the play screen:**
press: skip to the previous/next option
press and hold: search within current file
- press: select options, or start/pause/resume play
- ⑧ USB connector for power charging and data transfer
- ⑨ Remove the cap to use the USB connector

Home screen

Menu	Mode	To
	Music	play audio files
	FM radio	tune in to the FM radio
	Recording	create or listen to recordings
	Folder view	view files in folders view
	Settings	customize the settings of MIX
	Now playing	show the play screen

- From the Home screen, you can access functional menus by pressing the navigation buttons / and .
- To go back to previous screens, press  repeatedly; or, press and hold  to return to the Home screen.

Lock/unlock the keys

When the player is on, use the lock to prevent accidental operation.

- Briefly press  to lock or unlock the keys.
 - ↳ All buttons except the volume keys are locked and the display shows a lock icon.

Screen on/off

To save power, the screen switches off automatically after the pre-defined time duration if

- no new action is taken on **MIX**; and
- a value is selected in *** > [Display settings] > [Screen off timer]**.

To exit the power-saving mode

- Press any key.

5 Music

Manage music on PC

Organize your music files

Organize music files by song information

If the files contain song information (meta data or ID3 tag), the files can be sorted automatically by Song title, Artist, or Album on **MIX**.

Launch media management software to check or edit the file information. For example, click as shown in **Windows Media Player 11**. Select the desired song, and then, double click it to edit.



Organize music files by file folder

You can also organize music files in different folders as desired.

Transfer files in Windows Explorer

- 1 Connect **MIX** to a PC.
- 2 On the PC, under **My Computer** or **Computer**,
 - Find **MIX**;
 - Find the desired music files/folders.
- 3 From the PC, drag and drop music files/folders to **MIX**.

Add or delete music files

- 1 Connect **MIX** to a PC.
- 2 On the PC, under **My Computer** or **Computer**,
 - Find **MIX**.
- 3 On the PC, do the following:
 - To add files/folders, drag and drop music files/folders from the PC to **MIX**;
 - To delete files/folders, right click on the selection. Select the delete option as prompted.

Find music on the player

Find music by song information

From the Home screen, select  to find music by song information (meta data or ID3 tag) (see 'Organize your music files' on page 13):

[All songs]

- Alphabetically listed tracks

[Artists]

- Alphabetically listed artists
- Alphabetically listed albums
- Tracks listed in album order





[Albums]

- Alphanumerically listed albums
- Tracks listed in album order

Find music by file folder

From the Home screen, select  to find music by file folder (see 'Organize your music files' on page 13).

Play music



- 1 Press  or  to select a music file.
- 2 Press  to start play.
 - ↳ Play starts from current song.
 - ↳ On the play screen, you can see the file information and play status.
- 3 During playback,
 - Press  to pause and resume playback.
 - To go to the previous screen, press .
 - ↳ The play screen returns a few seconds later.



To select a music file on the play screen

- Repeatedly press  and .

To rewind or fast forward within current song

- On the play screen, press and hold  and .

6 FM radio

Note

- Plug in the supplied earphones when you tune in to radio stations. The earphones double as antenna. For better reception, move the earphone cable in different directions.

Tune in to radio stations

Auto tune

The first time you tune in to the radio, start Auto tune to search for stations.

- 1 From the Home screen, go to > [Auto tune].
↳ Up to 30 stations are stored as presets.

- 2 Press or repeatedly to select a preset station. Press to start play.

To select a preset on the play screen

- Press or repeatedly.



Tip

- When you move to a new place (such as a new city or country), restart auto tune for better reception.

Manual tune

Use Manual tune to search for a frequency or station.

- 1 From the Home screen, go to > [Manual tune].
↳ The last played station starts to play.
- 2 On the play screen, press and hold or .
↳ You tune in to the next station from current frequency.
 - For fine tuning, press or repeatedly.



Listen to the FM radio

- 1 From the Home screen, go to > [Presets].
- 2 Press / to select a preset station. Press to start play.
 - Press to select another preset station from [Presets]. Press to start play.
 - On the play screen, press or to select a preset.
- 3 If necessary, press and hold or to tune in to a radio station.

Store preset stations

On **MIX**, you can store up to 30 preset stations.





- 1 Tune in to a radio station.
- 2 Press to store current station as a preset.
- 3 Press or to select a location. Press .
↳ Current station is saved to the location as a preset.

7 Recordings

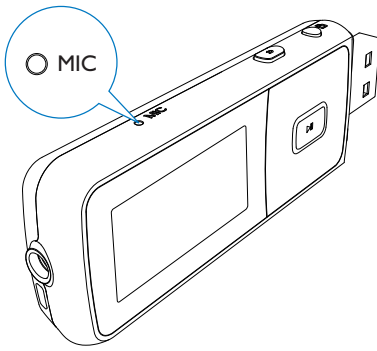
Record audio/voices

- 1 From the Home screen, select  > **[Start voice recording]**.
↳ Recording screen appears.
- 2 Ensure that the microphone is close to the sound source to be recorded.



- 3 Press  to toggle between pause and record. Press  to stop.
- 4 Press  to save the recording or press  to cancel.
↳ Recordings are saved on the player:
(Filename format: VOICEXXX.WAV, where XXX is the recording number that is generated automatically)



Tip

- You can find your recordings under **[Recordings Library] > [Voice]**.

Listen to recordings

From the Home screen, select  > **[Recordings Library] > [Voice]**.

- 1 Select a recording.
- 2 Press  to play your recording.

Delete one or more recordings

This is how to delete recordings in Windows Explorer:



- 1 Connect MIX to the computer.
- 2 In Windows Explorer, locate the folder **Recordings > Voice**.
- 3 Delete the recordings as you normally would on the computer.

Upload your recordings to a computer

- 1 Connect MIX to the computer.
- 2 In Windows Explorer, open MIX.
- 3 Select the folder **Recordings > Voice**.
- 4 Copy and paste the recordings to any location on the computer.

8 Settings

In , select your options for the player.

- 1 Press  /  to select an option.
- 2 Press  to confirm.

Play mode

In **[Play mode]**, select play modes for music/recording play:



[Repeat]	
[Repeat 1]	repeats current song/recording.
[Repeat all]	repeats all songs/recordings in current folder.
[Shuffle]	
[Shuffle all]	plays all songs/recordings in current folder in random order.

If both **[Repeat all]** and **[Shuffle all]** are activated,

- All songs/recordings in current folder are repeated in random order.

Sound settings

In **[Sound settings]**, select your option for sound settings:

[FullSound]	Restores the sonic details that music compression loses (for example, MP3, WMA).
[Equalizer]	Defines sound settings as desired.
[Volume limit]	Sets a maximum volume level for the device. In this way, you can always keep the volume within a level safe enough to your hearing. Press  /  to set the volume limit; Press  to confirm.

Note

- Equalizer is deactivated when you select FullSound.

Display settings

Theme

In **[Display settings] > [Theme]**, select the theme for the display.

Screen off timer

The screen enters the idle mode, if no new action is taken on **MIX**. After the pre-defined time duration, the idle screen is switched off automatically. To save battery power, select a low value for the time duration.

To set the time duration



- In **[Display settings] > [Screen off timer]**, select a time duration.
↳ After the selected time duration, the idle screen is switched off automatically.

To exit the power-saving mode

- Press any key.

Rotate screen

In **[Display settings] > [Rotate screen]**, select **[180°]** or **[0° (Normal)]** to turn the display upside down.

- ↳ After you turn the display upside down, you switch the functions of  and .

Language

In **[Language]**, select a language for the player.

Information

In **[Information]**, learn the following information about the device:

[Capacity:]	memory size
[Free space:]	space available
[Firmware version:]	current firmware version. Check the firmware version when updating firmware from the support website.
[Model:]	full product name. Check the full product name when updating firmware from the support website.
[Support site:]	web site that provides support for the device

Factory settings

In **[Factory settings]**, restore the player to factory settings. Files transferred to the player are retained.

9 Update MIX

MIX is controlled by an internal program called firmware. Newer versions of the firmware may have been released after you have purchased MIX.

The software program called **Philips Device Manager** can use your computer to check for firmware updates that are available on the Internet.

Install **Philips Device Manager** on your computer from MIX or download the latest version from www.philips.com/support.



Note

- Your music files are not affected by a firmware update.

Manually verify/ update firmware

- 1 Ensure that your computer is connected to the Internet.
- 2 Connect **MIX** to the computer.
- 3 On your computer, click **Start > Programs > Philips > Philips MP3 player > GoGear SA3MXX Device Manager** to launch **Philips Device Manager**.
- 4 Click **Update**
 - ↳ **Philips SA3MXX Device Manager** checks for updates and installs new firmware from the Internet, if available.
- 5 When the display shows **Update completed**, click **OK**.
- 6 Disconnect **MIX** from the computer.
 - ↳ **MIX** restarts after the firmware is updated and is ready for use again.

10 Troubleshooting

If MIX is not working properly or the display freezes, you can reset it without losing data:

How do I reset MIX?

- Insert a pen tip or other object into the reset hole located at the bottom of MIX. Hold until the player shuts down.
- If the reset option is unsuccessful, follow the steps how to recover MIX with the **Philips Device Manager**:

- 1** On your computer, select **Start > Programs > Philips > Philips MP3 player > GoGear SA3MXX Device Manager** to launch the **Philips Device Manager**.
- 2** Turn off MIX before you continue.
- 3** Press and hold the volume button  while you connect MIX to your computer.
- 4** Keep holding the key until the **Philips Device Manager** acknowledges MIX and enters the recovery mode.
- 5** On the computer, click the **Repair** button and follow the instructions of the **Philips Device Manager** to complete the recovery process.
- 6** When the recovery is completed, disconnect MIX from your computer.
- 7** Restart MIX.

11 Technical data

Power

Power supply: 150 mAh Li-ion polymer internal rechargeable battery
MP3 play time¹: up to 13 hours
Radio play time¹: up to 7 hours

Software

Philips Device Manager

Connectivity

Headphone 3.5 mm
USB 2.0 High speed

Sound

Channel separation: 40 dB
Frequency Response: 45 - 16,000 Hz
Output power: 10.0 mW
Signal to noise ratio: > 75 dB

Bit rates	Sampling rates
MP3:	
8 - 320 kbps in CBR and VBR	8, 11.025, 16, 22.050, 24, 32, 44.1, 48 kHz
FLAC:	
up to 1.1 Mbps	44.1 kHz
APE:	
up to 1.3 Mbps	48 Khz

Audio playback

Supported formats:

Music transfer³

Drag and drop in Windows® Explorer

Storage media

Built-in memory capacity²:
SA3MXX02 2GB NAND Flash
SA3MXX04 4GB NAND Flash
SA3MXX08 8GB NAND Flash

Display

Color LCD 128 x 64 pixels

Note

- ¹ Rechargeable batteries have a limited number of charge cycles. Battery life and number of charge cycles vary by use and settings.
- ² 1GB = 1 billion bytes; available storage capacity is less. Full memory capacity may not be available as some memory is reserved for the player. Storage capacity is based on 4 minutes per song and 128 kbps MP3 encoding.
- ³ Transfer speed depends on operating system and software configuration.

System requirements

- Windows® XP (SP3 or above) / Vista / 7
- Pentium III 800 MHz processor or higher
- 512 MB RAM
- 500 MB hard disk space
- Internet connection
- Windows® Internet Explorer 6.0 or later
- CD-ROM drive
- USB port

