

Register your product and get support at  
[www.philips.com/welcome](http://www.philips.com/welcome)

**GoGear**

SA2MXX02

SA2MXX04



---

EN User manual

---

**PHILIPS**

# Contents

---

|          |                                     |          |
|----------|-------------------------------------|----------|
| <b>1</b> | <b>Important safety information</b> | <b>2</b> |
|          | General maintenance                 | 2        |
|          | Recycling the product               | 4        |

---

|          |                     |          |
|----------|---------------------|----------|
| <b>2</b> | <b>Your new MIX</b> | <b>6</b> |
|          | What's in the box   | 6        |

---

|          |  |          |
|----------|--|----------|
| <b>3</b> | <b>Getting started</b>                   | <b>7</b> |
|          | Overview of the controls and connections | 7        |
|          | Limit the volume                         | 7        |
|          | Overview of the main menu                | 7        |
|          | Connect and charge                       | 8        |
|          | Software loaded on the MIX               | 8        |
|          | Files loaded on the MIX                  | 8        |

---

|          |                                 |          |
|----------|---------------------------------|----------|
| <b>4</b> | <b>Turn MIX on and off</b>      | <b>9</b> |
|          | Automatic standby and shut-down | 9        |

---

|          |                 |           |
|----------|-----------------|-----------|
| <b>5</b> | <b>Music</b>    | <b>10</b> |
|          | Listen to music | 10        |
|          | Find your music | 10        |

---

|          |                                 |           |
|----------|---------------------------------|-----------|
| <b>6</b> | <b>Radio</b>                    | <b>11</b> |
|          | Listen to FM radio              | 11        |
|          | Manually tune a radio station   | 11        |
|          | Auto-tune radio station presets | 11        |
|          | Play a preset radio station     | 11        |

---

|          |                                      |           |
|----------|--------------------------------------|-----------|
| <b>7</b> | <b>Recordings</b>                    | <b>12</b> |
|          | Record audio/voices                  | 12        |
|          | Listen to recordings                 | 12        |
|          | Delete one or more recordings        | 12        |
|          | Upload your recordings to a computer | 12        |

---

|          |  |           |
|----------|--|-----------|
| <b>8</b> | <b>Use the MIX to carry data files</b> | <b>13</b> |
|----------|--|-----------|

---

|          |                 |           |
|----------|-----------------|-----------|
| <b>9</b> | <b>Settings</b> | <b>14</b> |
|----------|-----------------|-----------|

---

|           |                                   |           |
|-----------|-----------------------------------|-----------|
| <b>10</b> | <b>Update MIX</b>                 | <b>15</b> |
|           | Manually verify / update firmware | 15        |

---

|           |                        |           |
|-----------|------------------------|-----------|
| <b>11</b> | <b>Troubleshooting</b> | <b>16</b> |
|-----------|------------------------|-----------|

---

|           |                       |           |
|-----------|-----------------------|-----------|
| <b>12</b> | <b>Technical data</b> | <b>17</b> |
|           | System requirements   | 17        |

---

|           |                 |           |
|-----------|-----------------|-----------|
| <b>13</b> | <b>Glossary</b> | <b>18</b> |
|-----------|-----------------|-----------|

## Need help?

Please visit

[www.philips.com/welcome](http://www.philips.com/welcome)

where you can access a full set of supporting materials such as the user manual, the latest software updates, and answers to frequently asked questions.

# 1 Important safety information

## General maintenance

The translation of this document is for reference only.

In the event of any inconsistency between the English version and the translated version, the English version shall prevail.

### Caution

- To avoid damage or malfunction:
- Do not expose the product to excessive heat caused by heating equipment or direct sunlight.
- Do not drop the product or allow objects to fall on your player.
- Do not allow the product to be submerged in water. Do not expose headphone socket or battery compartment to water, as water entering the set may cause major damage.
- Active mobile phones in the vicinity may cause interference.
- Back up your files. Ensure that you retain the original files you have downloaded to your device. Philips is not responsible for any loss of data if the product becomes damaged or not readable / legible.
- Manage (transfer, delete, etc.) your music files only with the supplied music software to avoid problems.
- Do not use any cleaning agents containing alcohol, ammonia, benzene, or abrasives as these may harm the product.

### About operating and storage temperatures

- Operate in a place where temperature is always between 0 and 35°C (32 to 95°F)
- Store in a place where temperature is always between -20 and 45°C (-4 to 113°F).
- Battery life may be shortened in low temperature conditions.

### Replacement parts/accessories:

Visit [www.philips.com/support](http://www.philips.com/support) to order replacement parts/accessories.

## Hearing Safety



### Listen at a moderate volume:

Using headphones at a high volume can impair your hearing. This product can produce sounds in decibel ranges that may cause hearing loss for a normal person, even for exposure less than a minute. The higher decibel ranges are offered for those that may have already experienced some hearing loss.

Sound can be deceiving. Over time your hearing 'comfort level' adapts to higher volumes of sound. So after prolonged listening, what sounds 'normal' can actually be loud and harmful to your hearing. To guard against this, set your volume to a safe level before your hearing adapts and leave it there.

To establish a safe volume level:

Set your volume control at a low setting.

Slowly increase the sound until you can hear it comfortably and clearly, without distortion.

Listen for reasonable periods of time:

Prolonged exposure to sound, even at normally 'safe' levels, can also cause hearing loss.

Be sure to use your equipment reasonably and take appropriate breaks.

Be sure to observe the following guidelines when using your headphones.

Listen at reasonable volumes for reasonable periods of time.

Be careful not to adjust the volume as your hearing adapts.

Do not turn up the volume so high that you can't hear what's around you.

You should use caution or temporarily discontinue use in potentially hazardous situations.

Do not use headphones while operating a motorized vehicle, cycling, skateboarding, etc.; it may create a traffic hazard and is illegal in many areas.

## Modifications

Modifications not authorized by the manufacturer may void user's authority to operate the product.

## Copyright information

All other brands and product names are trademarks of their respective companies or organizations.

Unauthorized duplication of any recordings whether downloaded from the Internet or made from audio CDs is a violation of copyright laws and international treaties.

The making of unauthorized copies of copy-protected material, including computer programs, files, broadcasts and sound recordings, may be an infringement of copyrights and constitute a criminal offense. This equipment should not be used for such purposes.

The Windows Media and the Windows logo are registered trademarks of Microsoft Corporation in the United States and/or other countries.

## Be responsible! Respect copyrights.



Be responsible  
Respect copyrights

Philips respects the intellectual property of others, and we ask our users to do the same. Multimedia content on the internet may have been created and/or distributed without the original copyright owner's authorization.

Copying or distributing unauthorized content may violate copyright laws in various countries including yours.

Compliance with copyright laws remains your responsibility.

The recording and transfer to the portable player of video streams downloaded to your computer is intended only for use with public domain or properly licensed content. You may only use such content for your private, non-commercial use and shall respect eventual

copyright instructions provided by the copyright owner of the work. Such instruction may state that no further copies shall be made.

Video streams may include copy protection technology that prohibits further copying. For such situations the recording function will not work and you will be notified with a message.

## Data logging

Philips is committed to improving the quality of your product and enhancing the Philips user experience. To understand the usage profile of this device, this device logs some info / data to the non-volatile memory region of the device. These data are used to identify and detect any failures or problems you as a user may experience while using the device. The data stored, for example, will be the duration of playback in music mode, duration of playback in turner mode, how many times battery low was encountered, etc. The data stored do not reveal the content or media used on the device or the source of downloads. The data stored on the device are retrieved and used ONLY if the user returns the device to the Philips service center and ONLY to simplify error detection and prevention. The data stored shall be made available to user on user's first request.

## Monkey's Audio decoder

- ① The Monkey's Audio SDK and source code can be freely used to add APE format playback, encoding, or tagging support to any product, free or commercial. Use of the code for proprietary efforts that don't support the official APE format require written consent of the author.
- ② Monkey's Audio source can be included in GPL and open-source software, although Monkey's Audio itself will not be subjected to external licensing requirements or other viral source restrictions.

- ③ Code changes and improvements must be contributed back to the Monkey's Audio project free from restrictions or royalties, unless exempted by express written consent of the author.
- ④ Any source code, ideas, or libraries used must be plainly acknowledged in the software using the code.
- ⑤ Although the software has been tested thoroughly, the author is in no way responsible for damages due to bugs or misuse.

If you do not completely agree with all of the previous stipulations, you must cease using this source code and remove it from your storage device.

### FLAC decoder

Copyright (C) 2000,2001,2002,2003,2004,2005,2006,2007,2008,2009 Josh Coalson

Redistribution and use in source and binary forms, with or without modification, are permitted provided that the following conditions are met:

- Redistributions of source code must retain the above copyright notice, this list of conditions and the following disclaimer.
- Redistributions in binary form must reproduce the above copyright notice, this list of conditions and the following disclaimer in the documentation and/or other materials provided with the distribution.
- Neither the name of the Xiph.org Foundation nor the names of its contributors may be used to endorse or promote products derived from this software without specific prior written permission.

THIS SOFTWARE IS PROVIDED BY THE COPYRIGHT HOLDERS AND CONTRIBUTORS "AS IS" AND ANY EXPRESS OR IMPLIED WARRANTIES, INCLUDING, BUT NOT LIMITED TO, THE IMPLIED WARRANTIES

OF MERCHANTABILITY AND FITNESS FOR A PARTICULAR PURPOSE ARE DISCLAIMED. IN NO EVENT SHALL THE FOUNDATION OR CONTRIBUTORS BE LIABLE FOR ANY DIRECT, INDIRECT, INCIDENTAL, SPECIAL, EXEMPLARY, OR CONSEQUENTIAL DAMAGES (INCLUDING, BUT NOT LIMITED TO, PROCUREMENT OF SUBSTITUTE GOODS OR SERVICES; LOSS OF USE, DATA, OR PROFITS; OR BUSINESS INTERRUPTION) HOWEVER CAUSED AND ON ANY THEORY OF LIABILITY, WHETHER IN CONTRACT, STRICT LIABILITY, OR TORT (INCLUDING NEGLIGENCE OR OTHERWISE) ARISING IN ANY WAY OUT OF THE USE OF THIS SOFTWARE, EVEN IF ADVISED OF THE POSSIBILITY OF SUCH DAMAGE.

---

## Recycling the product

Your product is designed and manufactured with high quality materials and components, which can be recycled and reused. When you see the crossed-out wheel bin symbol attached to a product, it means the product is covered by the European Directive 2002/96/EC:



Never dispose of your product with other household waste. Please inform yourself about the local rules on the separate collection of electrical and electronic products. The correct disposal of your old product helps prevent potentially negative consequences on the environment and human health.

## ! Caution

- For products with "non-exchangeable" built-in batteries: The removal of (or the attempt to remove) the battery invalidates the warranty. This procedure is only to be performed at the end of the product's life.

Your product contains a built-in rechargeable battery covered by the European Directive 2006/66/EC, which cannot be disposed of with normal household waste.



To safeguard the functionality and safety of your product, take your product to an official collection point or service center where a professional can remove the battery as shown:

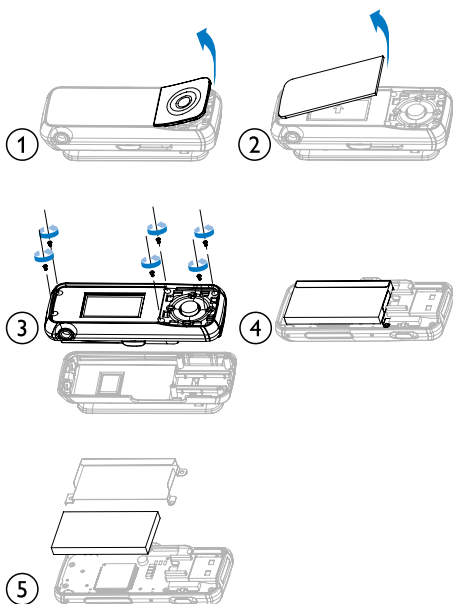

Please inform yourself about the local rules on separate collection of batteries. The correct disposal of batteries helps prevent potentially negative consequences on the environment and human health.

### Notice for the European Union

This product complies with the radio interference requirements of the European Union.

## 2 Your new MIX

MIX allows you to

- play music
- listen to FM radio
- make voice recordings

---

### What's in the box

Check that you have received the following items:

Player



Earphones



Quick start guide



#### Note

- The images serve as reference only. Philips reserves the right to change color/design without notice.

# 3 Getting started

## Overview of the controls and connections

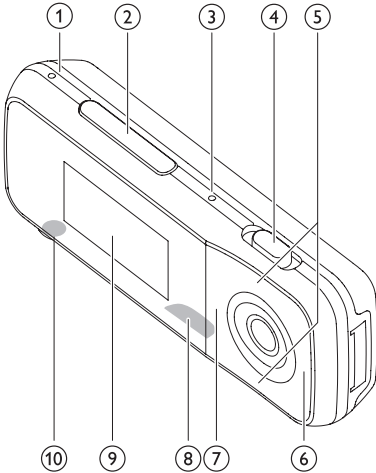

|   |               |   |
|---|---------------|---|
| ① | <b>MIC</b>    | microphone  |
| ② | <b>-VOL +</b> | press: increase/decrease the volume<br>press and hold: increase/decrease fast |
| ③ | <b>RESET</b>  | press: reset MIX  |
| ④ | <b>🔒</b>      | slide: lock/unlock all buttons except <b>-VOL +</b>                           |
|   | <b>🔌</b>      | slide and hold: turn MIX on/off   |
| ⑤ | <b>▲ / ▼</b>  | press: scroll up/down<br>press and hold: scroll up/down at high speed         |
| ⑥ | <b>▶  </b>    | press: play/pause   |
| ⑦ | <b>↶</b>      | press: back one level<br>press and hold: return to root menu                  |
| ⑧ | <b>🔌</b>      | slide out: extend USB connector plug  |
| ⑨ |               | display   |
| ⑩ | <b>🎧</b>      | headphone jack  |

## Limit the volume

### ! Caution

- Listening to loud sounds for longer than a moment can be harmful to the listener.

You can set the volume level of MIX to limit the maximum volume output.

- 1 From the main menu, select **[Settings]** > **[Sound settings]** > **[Volume limit]**.
- 2 Press the **- / +** volume controls to adjust the level.
- 3 Press **▶||** to confirm.
  - ↳ When you set a volume limit, MIX can no longer exceed the set volume, even if you press the volume **+** button.

To enable maximum volume again:

- 1 Select **[Settings]** > **[Sound settings]** > **[Volume limit]**.
- 2 Set the volume limit to maximum.
- 3 Press **▶||** to confirm.

## Overview of the main menu

| Menu      | Mode        | To                             |
|-----------|-------------|--------------------------------|
| <b>🎵</b>  | Music       | play digital audio tracks      |
| <b>📻</b>  | FM radio    | listen to FM radio             |
| <b>🎙️</b> | Recording   | create or listen to recordings |
| <b>📁</b>  | Folder view | view files in folders          |
| <b>⚙️</b> | Settings    | customize the settings of MIX  |
| <b>🕒</b>  | Now playing | show the current play screen   |



## Connect and charge

MIX has a built-in battery that can be charged through the USB port of a computer.

### Connect MIX to a computer

- 1 Slide out the integrated USB plug  of MIX.
- 2 Connect the USB plug to a spare USB port on your computer.
- 3 Turn on your computer.  
↳ MIX charges.

#### Note

- For first-time use, allow MIX to charge for 3 hours.
- The charging animation stops and the  icon is displayed when the charging process is completed.

When you connect the MIX to the PC for the first time, a pop-up window appears:

- 1 Select **Philips Device Manager**.
- 2 Follow the on-screen instructions to complete the installation of the software.

#### Note

- The installation requires you to agree to the license terms.

If the pop-up window is not displayed automatically:





- 1 Select **My Computer** (Windows XP / Windows 2000) / **Computer** (Windows Vista / Windows 7).
- 2 Right click on the **Philips GoGear MIX** icon.
- 3 Select **Install Philips Device Manager**.
- 4 Follow the on-screen instructions to complete the installation of the software.

#### Note

- The installation requires you to agree to the license terms.

### Battery level indication

The display indicates the approximate levels of the battery status as follows:

|   |   |   |   |   |
|---|---|---|---|---|
|  |  |  |  |  |
| 100%  | 75%   | 50%   | 25%   | 0%  |

- ↳ A flashing battery screen indicates that the battery is low. The player saves all settings and switches off within 60 seconds.

#### Note

- Rechargeable batteries have a limited number of charge cycles. Battery life and number of charge cycles vary by use and settings.
- The charging animation stops and the  icon is displayed when the charging process is completed.

#### Tip

- You can conserve battery power and increase the play time of MIX if you ensure that the shortest timer setting is selected. (To check/adjust the timer settings, go to  > **[Display Settings]** > **[Screen off timer]**.)

## Software loaded on the MIX

MIX comes with the following software:

- Philips Device Manager (helps you get firmware updates for MIX)

## Files loaded on the MIX

The following files are loaded on MIX:

- User manual

## 4 Turn MIX on and off

To toggle between modes on and off, slide and hold  for approximately 2 seconds.

---

### Automatic standby and shut-down

MIX has an automatic standby and shut-down feature that can save battery power. After 10 minutes in idle mode (no music plays, no button is pressed), MIX turns off.

- 1 Slide and hold  for approximately 2 seconds to turn MIX on again.



MIX has a lock switch to prevent accidental operation.

- 1 To lock the buttons when you play, move the slider to position .
  - ↳ All buttons except the volume keys are locked and the display shows a lock icon.
- 2 To unlock the buttons again, move the slider to the center position.

# 5 Music

---

## Listen to music

- 1 From the main menu, select  to enter music mode.
- 2 Navigate the sub-menus to select your music.
- 3 Press  to play.
  - Press  to toggle between pause and play.

---

## Find your music

From the main menu, select  to enter music mode.

MIX offers the following menu options:

### [All songs]

- Alphabetically listed tracks

### [Artists]

- Alphabetically listed artists
- Alphabetically listed albums
- Tracks listed in album order

### [Albums]

- Alphanumerically listed albums
- Tracks listed in album order



### Note

- Alternatively, you can select  from the main menu and find your music files in folder view.

## 6 Radio

### Listen to FM radio

- 1 From the main menu, select  to enter radio mode.
  - ↳ The earphones cable acts as FM antenna.







#### Tip

- Radio play stops when you switch to another mode or when you turn off MIX.





### Manually tune a radio station

While in  mode, you can manually tune to a radio station:







- 1 To search for the next stronger signal, press and hold  / .
- 2 To fine tune the frequency, briefly press  / .

### Auto-tune radio station presets

The auto-tune feature of MIX helps you find radio stations and save them under the preset numbers.

- 1 While in  mode with the earphones connected, press .
- 2 Select **[Auto tune]**.
  - ↳ The radio automatically tunes radio stations and saves the frequencies to presets. There are 20 presets available.
    - To stop auto tuning, press .
    - To return to the main menu, press and hold  for 2 seconds.

### Play a preset radio station

- 1 While in  mode, select preset.
- 2 Press  or  to change to another preset.
- 3 To search for the next stronger signal, press and hold  or  for 2 seconds.
  - To return to the main menu, press and hold  for 2 seconds.



#### Note





- To play preset radio stations, you first have to store radio stations under presets.

# 7 Recordings

---

## Record audio/voices

This is how you can record audio/voices with the built-in microphone (see section **Overview** for location of built-in microphone):

- 1 From the main menu, select  > **[Start voice recording]**.
  - Press  to toggle between pause and record.
- 2 Press  to stop.
- 3 Press  to save the recording or press  to cancel.
  - ↳ Recordings are saved on the player. (Filename format: VOICEXXX.WAV, where XXX is the recording number that is generated automatically.)





### Tip

- You can find your recordings under **[Recordings Library] > [Voice]**.

---

## Listen to recordings

Listen to voice/audio recordings:

- 1 From the  menu select **[Recordings Library] > [Voice]**.
- 2 Select a recording.
- 3 Press  to play your recording.

---

## Delete one or more recordings

This is how to delete recordings in Windows Explorer:

- 1 Connect MIX to the computer.
- 2 In Windows Explorer, locate the folder **Recordings > Voice**.
- 3 Delete the recordings as you normally would on the computer.

---

## Upload your recordings to a computer

- 1 Connect MIX to the computer.
- 2 In Windows Explorer, open MIX.
- 3 Select the folder **Recordings > Voice**.
- 4 Copy and paste the recordings to any location on the computer.

## 8 Use the MIX to carry data files

This is how you use MIX to store and carry data files:

- 1 Connect MIX to the computer (for instructions see section **Connect and charge**).
- 2 On the computer in Windows Explorer, copy the data files and paste them to MIX.



### Tip

- Use the computer to transfer your data files back to the computer or to delete your data files from MIX.

# 9 Settings

This is how you customize MIX:

From the main menu, select **\*** to enter the settings mode.

In the settings menu, navigate as follows:

- 1 Press **▲** / **▼** to select an option.
- 2 Press **▶||** to confirm a selection and go to the next level (when available).
  - Press **↶** to return to the previous level.
  - Press and hold **↶** to exit the **\*** menu.

In the settings menu, the following options are available:

| Settings                             | Options menu | Sub-options menu  |
|--------------------------------------|--------------|---|
| Play mode                            | Repeat       | <ul style="list-style-type: none"> <li>• Repeat off</li> <li>• Repeat 1</li> <li>• Repeat all (default)</li> </ul>  |
|                                      | Shuffle      | <ul style="list-style-type: none"> <li>• Shuffle off (default)</li> <li>• Shuffle all</li> </ul>  |
| Sound settings                       | FullSound    | <ul style="list-style-type: none"> <li>• Off</li> <li>• On* (default)</li> </ul>  |
|                                      | Equalizer    | <ul style="list-style-type: none"> <li>• Off (default)</li> <li>• Rock</li> <li>• Funk</li> <li>• Hip hop</li> <li>• Jazz</li> <li>• Classical</li> <li>• Techno</li> <li>• Custom</li> </ul> |
| Volume limit Press <b>▶  </b> to set |              |   |

| Settings         | Options menu   | Sub-options menu  |
|------------------|--|---|
| Display settings | Theme  | <ul style="list-style-type: none"> <li>• Black (default)</li> <li>• Blue</li> <li>• Red</li> </ul>  |
|                  | Screen off timer   | <ul style="list-style-type: none"> <li>• 15 seconds (default)</li> <li>• 30 seconds</li> <li>• 45 seconds</li> <li>• Always on</li> </ul> |
|                  | Rotate screen  | <ul style="list-style-type: none"> <li>• 0° (default)</li> <li>• 180°</li> </ul>  |
| Language         | <ul style="list-style-type: none"> <li>• English</li> <li>• Simplified Chinese (default)</li> <li>• Traditional Chinese</li> <li>• Japanese</li> <li>• Korean</li> </ul> |   |
| Information      | Capacity<br>Free space<br>Firmware version<br>Model<br>Support site  |   |
| Legal            | Legal information  |   |
| Factory settings | Restore factory settings (files are not affected)  | <ul style="list-style-type: none"> <li>• Yes</li> <li>• No (default)</li> </ul>   |

\*Equalizer deactivates when FullSound is selected.

# 10 Update MIX

MIX is controlled by an internal program called firmware. Newer versions of the firmware may have been released after you have purchased MIX.

The software program called **Philips Device Manager** can use your computer to check for firmware updates that are available on the Internet.

Install **Philips Device Manager** on your computer from MIX or download the latest version from [www.philips.com/support](http://www.philips.com/support).

## Note

- Your music files are not affected by a firmware update.

---

## Manually verify / update firmware

- 1 Ensure that your computer is connected to the Internet.
- 2 Connect MIX to the computer (see section **Connect MIX to a computer** for instructions).
- 3 On your computer, click **Start > Programs > Philips > Philips MP3 player > GoGear SA2MXX Device Manager** to launch the **Philips Device Manager** to launch **Philips Device Manager**.
- 4 Click **Update**
  - ↳ **Philips SA2MXX Device Manager** checks for updates and installs new firmware from the Internet, if available.
- 5 When the display shows **Update completed**, click **OK**.
- 6 Disconnect MIX from the computer.
  - ↳ MIX restarts after the firmware is updated and is ready for use again.



# 11 Troubleshooting

If MIX is not working properly or the display freezes, you can reset it without losing data:

## How do I reset MIX?

- Insert a pen tip or other object into the reset hole located at the bottom of MIX. Hold until the player shuts down.
- If the reset option is unsuccessful, follow the steps how to recover MIX with the **Philips Device Manager**:
  - 1 On your computer, select **Start > Programs > Philips > Philips MP3 player > GoGear SA2MXX Device Manager** to launch the **Philips Device Manager**.
  - 2 Turn off MIX before you continue.
  - 3 Press and hold the volume button **+** while you connect MIX to your computer.
  - 4 Keep holding the key until the **Philips Device Manager** acknowledges MIX and enters the recovery mode.
  - 5 On the computer, click the **Repair** button and follow the instructions of the **Philips Device Manager** to complete the recovery process.
  - 6 When the recovery is completed, disconnect MIX from your computer.
  - 7 Restart MIX.

# 12 Technical data

---

## Power

Power supply: 250 mAh Li-ion polymer  
internal rechargeable battery  
Play time<sup>1</sup>: 20 hours

---

## Software

Philips Device Manager

---

## Connectivity

Headphone 3.5 mm  
USB 2.0 High speed

---

## Sound

Channel separation: 40 dB  
Frequency Response: 40 - 18,000 Hz  
Output power: 10.0 mW  
Signal to noise ratio: > 78 dB

---

## Audio playback

Supported formats:

| Bit rates | Sampling rates |
|-----------|----------------|
|-----------|----------------|

MP3:

|                                |   |
|--------------------------------|---|
| 8 - 320 kbps in CBR<br>and VBR | 8, 11,025, 16,<br>22,050, 24, 32,<br>44.1, 48 kHz |
|--------------------------------|---|

WMA:

|  |   |
|--|---|
| 10 - 320 kbps in CBR<br>32 - 192 kbps in VBR | 8, 11,025, 16,<br>22,050, 32, 44.1,<br>48 kHz |
|--|---|

FLAC:

|                |          |
|----------------|----------|
| up to 1.1 Mbps | 44.1 kHz |
|----------------|----------|

APE:

|                |        |
|----------------|--------|
| up to 1.3 Mbps | 48 KHz |
|----------------|--------|

---

## Music transfer<sup>3</sup>

Drag and drop in Windows® Explorer

---

## Storage media

Built-in memory capacity<sup>2</sup>:  
SA2MXX02 2GB NAND Flash  
SA2MXX04 4GB NAND Flash

---

## Display

Color LCD 128 x 64 pixels

---

## Note

- <sup>1</sup> Rechargeable batteries have a limited number of charge cycles. Battery life and number of charge cycles vary by use and settings.
- <sup>2</sup> 1GB = 1 billion bytes; available storage capacity is less. Full memory capacity may not be available as some memory is reserved for the player. Storage capacity is based on 4 minutes per song and 128 kbps MP3 encoding.
- <sup>3</sup> Transfer speed depends on operating system and software configuration.

---

## System requirements

- Windows® XP (SP3 or above) / Vista / 7
- Pentium III 800 MHz processor or higher
- 512 MB RAM
- 500 MB hard disk space
- Internet connection
- Windows® Internet Explorer 6.0 or later
- USB port

# 13 Glossary

---

## D

### **Decibel (dB)**

A unit of measure used to express relative difference in power or intensity of sound.

---

## F

### **FM (Frequency Modulation)**

In radio broadcasting: a method of modulation in which the frequency of the carrier voltage is varied with the frequency of the modulation voltage.

---

## L

### **LCD (Liquid Crystal Display)**

Probably the most common way to show visual information on non-computer electronic equipment.

---

## M

### **MP3**

A file format with a sound data compression system. MP3 is the abbreviation of Motion Picture Experts Group 1 (or MPEG-1) Audio Layer 3. With the MP3 format, one CD-R or CD-RW can contain about 10 times more data than a regular CD.

---

## S

### **Shuffle**

A feature that plays audio files (tracks) in random order.

---

## V

### **Volume**

Volume is the most common word used to specify the control of relative loudness of sounds. It also pertains to the function on many electronic devices that is used to control the loudness.

---

## W

### **WMA (Windows Media Audio)**

An audio format owned by Microsoft, is a part of Microsoft Windows Media technology. Includes Microsoft Digital Rights Management tools, Windows Media Video encoding technology, and Windows Media Audio encoding technology.

