

Philips audio player

User manual

SA1200
SA1202
SA1203
SA1205
SA1210
SA1215
SA1216



PHILIPS

Need help?

Please visit

www.philips.com/support

where you can access to a full set of supporting materials such as user manual, flash tutorial, the latest software upgrades and answers to frequently asked questions.

Or call our Customer Care Helpline, where our professional support team will be pleased to assist you in solving any issues you may have with your player.

Country	Helpdesk	Tariff / min	Keep ready
Europe			
Austria	0820 901115	€0.20	Das Kaufdatum, Modellnummer und Serial nummer
Belgium	070 253 010	€0.17	La date d'achat la référence et le numéro de série du produit
Czech Republic	800142100	Mistní tarif	Datum zakoupení, číslo modelu a sériové číslo
Denmark	3525 8761	Lokal tarif	Indkøbsdato, type-, model- og serienummer
Finland	09 2290 1908	Paikallinen hinta	Ostopäivä ja tarkka mallinnumero ja sarjanumero
France	08 9165 0006	€0.23	La date d'achat la référence et le numéro de série du produit
Germany	0180 5 007 532	€0,12	Das Kaufdatum, Modellnummer und Serial nummer
Greek	0 0800 3122 1223	1 αστική μονάδα	Την ημερομηνία αγοράς και τον ακριβή κωδικό μοντέλου και τον αριθμό σειράς του προϊόντος σας
Hungary	06 80 018544	Helyi tarifa	A vásárlás dátuma, modell és száriaszám
Ireland	01 601 1161	Local tariff	Date of Purchase, Model number and Serial number
Italy	199 404 042	€0.25	La data di acquisto, numero di modello e numero di serie
Luxemburg	26 84 30 00	Tarification locale	La date d'achat, la référence et le numéro de série du produit
Netherlands	0900 0400 063	€0.20	De datum van aankoop, modelnummer en serienummer
Norway	2270 8250	Lokal tariff	Datoen da du kjøpte produktet & modellnummer & serienummeret
Poland	022 3491504	Cena połączenia lokalnego	Data zakupu, Numer modelu i numer seryjny
Portugal	2 1359 1440	Preço local	A data de compra, número do modelo e número de série
Russia	(495) 961-1111 8 800 200-0880	по России звонок бесплатный	Дата покупки, Номер модели и Серийный номер
Slovakia	0800004551	Miestna tarifa	Dátum zakúpenia, číslo modelu a sériové číslo
Spain	902 888 785	€0,15	Fecha de compra y número del modelo y número de serie
Sweden	08 632 0016	Lokal kostnad	Inköpsdatum, modellnummer och serienummer
Switzerland	02 2310 2116	Ortstarif	Das Kaufdatum, Modellnummer und Serial nummer
UK	0906 1010 017	£0.15	Date of Purchase, Model number and Serial number
North America			
Canada	0820 901115 (Francophone) 1-888-744-5477 (English / Spanish)	Free	Date of Purchase, Model number and Serial number
USA	1-888-744-5477	Free	Date of Purchase, Model number and Serial number
South America			
Argentina	11 4544 2047	Tarifa local	Fecha de compra y número del modelo y número de serie
Brazil	0800 701 02 03 (Except Sao Paulo) 2121 0203 (Sao Paulo)	Grátis	A data de compra, número do modelo e número de série
Chile	600 744 5477	Tarifa local	Fecha de compra y número del modelo y número de serie
Mexico	01 800 504 6200	Gratis	Fecha de compra y número del modelo y número de serie
Asia			
China	4008 800 008	本地费率	购买日期、型号及序号
Hong Kong	2619 9663	本地费率	購買日期、型號及序號
Korea	02 709 1200	관세	구매일자, 모델 번호, 시리얼 번호

- 2 Your new player
 - 2 Accessories
 - 2 Register your product
 - 2 Overview of controls and connections
- 3 Getting started
 - 3 Install
 - 3 Connect
 - 4 Transfer
 - 4 Enjoy
- 5 Music mode
 - 6 Folder skip
 - 6 Playback features
- 7 Recordings
 - 7 Make recordings
 - 7 Play back recordings
 - 7 Upload recordings to the computer
 - 7 Delete recordings
- 8 Settings
- 8 About Firmware manager
 - 8 Install Firmware Manager
 - 8 Update firmware
- 8 Troubleshooting
- 10 Technical Data
- 11 Important safety information

Your new player

With your newly purchased player, you can enjoy the following:

- MP3 and WMA playback
- Voice recording

Accessories



Headphones



AAA battery



USB Extension cable



CD-ROM with user manual, drivers and
Frequently Asked Questions

Register your product

We strongly recommend that you register your product in order to gain access to free updates. To register your product, please log on to www.philips.com/register so that we can inform you as soon as new updates become available.

Overview of controls and connections

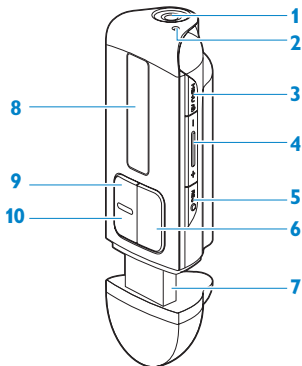

1		Headphones jack
2	MIC	Microphone
3	MENU/LOCK	Press to access the menu Press and hold to disable or enable key press
4	+ / -	Volume control
5	REC	Start or stop voice recording
6		Power on/off and Play/Pause, confirm a menu setting
7	USB	USB connector
8	Display	Dynamically display menu, options and track information
9		Press to skip to previous song, press and hold to skip to previous folder. In menu mode, press to navigate through menu.
10		Press to skip to next song, press and hold to skip to next folder. In menu mode, press to navigate through menu.

Getting started

Install

- 1 Insert the CD supplied with your product into the CD ROM drive of your PC.
- 2 Follow the onscreen instructions to complete the installation of the Firmware manager and if required, device drivers.
- 3 If the installation program does not start automatically, browse the CD contents via Windows Explorer and run the program by double clicking on the file ending with .exe.

Windows 98SE user: To avoid installation problems, **do not connect** your device to the computer until **after** installation completes.

Lost your CD? Don't worry, you can download the CD contents from www.philips.com/support or www.philips.com/usasupport (for U.S. residents).

Connect

Insert the battery

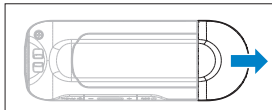

- 1 Remove the USB cap.

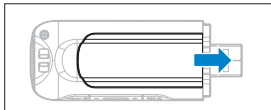

- 2 Remove the battery door by sliding it in the direction of arrow.

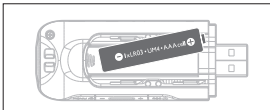

- 3 Insert the supplied AAA battery into the battery compartment.

Read the battery level indication of your player

The approximate power levels of your battery are indicated as follows:



Full



Two-thirds full



Half full



Low



Empty

TIP When the batteries are nearly empty, the battery low screen  blinks. Your player will power down in less than 60 seconds. Your player will save all settings and un-finished recordings before it powers down.

Transfer

Your player appears as a USB mass storage in Windows Explorer. You can organize files and transfer music to your player during USB connection.

- 1 Click and highlight one or more songs to transfer between your player and your computer.
- 2 Use drag and drop actions to complete your transfer.

TIP To transfer music CDs to your player use software such as Musicmatch Jukebox or Windows Media Player, rip (convert) the songs on your music CD into MP3/WMA files. Copy the files into your digital audio player via Windows Explorer. Free versions of these programs can be downloaded from the internet.

TIP Organize your music in folders. Your player will play your music folder by folder so that you can organize your music by artists and albums. You can drag and drop entire folders to your player. Your player will play the music files that are not inside folders first followed by the music files inside folders.

Disconnect your player safely

Exit any active application working with your player. Remove your player safely by clicking  in the task tray shown in your PC.

Windows 98SE users: There is no  in the task tray of your PC.

Simply disconnect the player when the animation  stops which means the transfer is complete.

Enjoy

Power on/off

To power on, press **▶||** until the PHILIPS splash screen appears.



To power off, press and hold **▶||** again until there is no display on the screen.

TIP Your player automatically powers down if there is no operation and no music played for 3 minutes.

Navigate the menu

Your player has an intuitive menu navigation system to guide you through various settings and operations. Use **◀◀** and **▶▶** to browse through menus. Press **▶||** to confirm your selection.

When your player powers up, you will see the Root menu. You can also press **MENU** to access the root menu. It includes:

 Music	Play your digital music tracks
 Recordings	Play your recordings
 Settings	Change the playmode, equalizer or language settings, display the player information

Music mode (also applicable to playback of recordings)

From the root menu, select Music to enter the Music mode. Your player will play the music per folder in alphabetical order. Basic operations in music mode include:

Basic operations	Controls to press
Go for next song	Press ▶▶
Go for previous song	Press ◀◀
Pause music	Press ▶ during music playback
Go to next folder	Press and hold ▶▶
Go to previous folder	Press and hold ◀◀
Volume Control	Press +/-

This player does not support copy right protected (Digital Rights Management – DRM) WMA songs bought from the Internet.

Folder skip

Folder skip functions allows you to go to next or previous folders quickly.

- 1 Press and hold **⏮ / ⏭** will enter into Folder skip function.
> The display will show the folder icon and the folder name and scroll through all folders on the player in alphabetical order.
- 2 Release **⏮ / ⏭** when you see the folder of your selection.
> The player will start playing the first song in your selected folder.

Folder skip is applicable to the highest level of folders only. Folder skip is not available when the play mode is set to "Shuffle all".

Folder skip can be disabled in the Settings menu.



- 1 Go to **Settings**.
- 2 Select **▶▶** Function and choose **Fast forward / rewind**.
- 3 Press and hold **⏮** or **⏭** to fast rewind or fast forward the currently playing song.

Playback features

Play modes

You can set your player to play songs randomly or repeatedly.

- 1 Press **MENU**, select Settings and then select Play modes.
- 2 Press **⏮ / ⏭** to browse through different play modes (Off, Shuffle, Repeat 1, Repeat all).
- 3 Press **▶||** to confirm your selection.

Icon	Meaning
Off	Normal Playback
 Shuffle	Play all songs randomly
 Repeat 1	Play one song repeatedly
 Repeat all	Play all songs repeatedly

Playmodes are not available in recordings playback.

Equalizers

You can set your player to play music with different EQ (equalizers).

- 1 Press **MENU**, select **Settings**, then select **Equalizer**.
- 2 Press **⏮ / ⏭** to select **Rock, Jazz, Pop, Classical** or **Off**.
- 3 Press **▶||** to confirm your selection.

Recordings

Your player allows you to make voice recordings and play back your recordings.

Make recordings

- 1 Press **REC** to start voice recording.
> Your player shows the recording state.
- 2 Press **REC** again to stop voice recording
> Your player shows the saving state. Your voice recording will be saved on your player. (Filename: VOICEXXX.WAV where XXX is the recording number which is automatically generated.)

TIP You can pause and restart a recording anytime with **▶||** key.

Play back recordings

You can find your recordings in the Recordings mode.

- 1 From the root menu, select **RECORDINGS** to enter into the Recordings mode. Your player will play all your recordings alphabetically and will start with the last made recording.
- 2 Press **▶||** to pause the current playing recording.
- 3 Press **◀◀** or **▶▶** to play next or previous recordings.
- 4 Press and hold **◀◀** or **▶▶** to fast forward or fast rewind the current recording playback.

Upload recordings to the computer

- 1 Connect your player to your computer.
- 2 Select your player in Windows Explorer.
> You will find a **VOICE** folder. This folder contains the recordings.
- 3 Copy and paste the recordings to any desired location on your computer.

Delete recordings

Recordings can only be deleted on the computer.

- 1 Connect your player to your computer.
- 2 Select your player in Windows Explorer.
- 3 Double click the **VOICE** folder.
- 4 Select the files you want to delete and press **Delete** on your computer keyboard.

Settings

You can set your preferences in your player to suit your needs.

- 1 Press **MENU** and choose **SETTINGS**.
- 2 Press **◀◀ / ▶▶** to browse through the various options and press **▶▶** to confirm your selection.
- 3 Press **MENU** to exit the current settings screen.

Settings	Further Options
Playmode	Off / Shuffle / Repeat 1 / Repeat all
Equalizer	Rock / Jazz / Pop / Classical / Off
Language	English / French / German
Information	FW (Firmware) version / Memory available
▶▶ Function	Folder skip / Fast forward/rewind

About Firmware manager

Your player is controlled by an internal program called firmware. With **Firmware Manager**, you can update and restore your player with a few simple clicks.

Install Firmware Manager

- 1 Insert the supplied CD into the CD ROM drive of your computer.
- 2 Follow the onscreen instructions to begin and complete the installation.

Update firmware



Regularly check www.philips.com/support for new Firmware updates. Follow the instruction on the website to update the firmware of your player.

Troubleshooting

If a fault occurs, first check the points listed in the following pages. For further help and other troubleshooting tips, please also check out FAQs at www.philips.com/support.

If you are unable to find a solution by following these hints, consult your dealer or service center.

WARNING Under no circumstances should you try to repair the set yourself, as this will invalidate the warranty.

Symptoms	Solutions
The player does not react on any key press, did hang up or freeze up	Remove and insert the battery again.
There is no sound	Make sure your headphones are inserted all the way into the headphones jack.
My player shows 	Press and hold MENU/LOCK to enable key press.
The player does not switch on and seems dead	Insert a new battery Press ▶ and power up your player. In case this does not work: Press and hold ▶ while connecting the device to the PC. Start Firmware Manager , your device will be automatically recovered.
The player shows: "Player problem! Connect to PC"	Connect your player to the PC, open Windows Explorer , open "My computer", select your player, right click and select "Format" . Select FAT or FAT32 file system and press Start to format your player. WARNING All media contents will be erased!
The player shows  Memory full!	Connect your player to the computer. Delete unwanted files, unplug safely and record again.
The player shows "Maximum number of files exceeded!"	The maximum total number of files, recordings and folders on your player is 450. Connect your player to your computer, delete unwanted files, unplug safely and record again.
The player shows "File format not supported!"	This player does not support copyright protected (DRM) WMA tracks bought from on-line music stores, only unprotected WMA files can be played back on this player. The song is in a format that is not supported by the player. Only MP3, WMA and WAV files are supported.
Some songs do not show up or playback on the player	<ul style="list-style-type: none"> • This player does not support copyright protected (DRM) WMA tracks bought from on-line music stores, only unprotected WMA files can be played back on this player. The song is in a format that is not supported by the player. Only MP3, WMA and WAV files are supported. • The audio file might be corrupted, try to playback the file on your PC first. If it does not play, rip the song again. • Total number of sub-folders and songs within one single folder exceeds 50. If there is no folder created, you will be able to have maximum of 450 tracks. • Songs with bit rates higher than 320kbps are not supported by the player.

Technical Data

Power supply	AAA alkaline*	
Picture / Display	Mono display, 32 x 128 pixels	
Sound	Channel separation	40dB
	Equalizer settings	Rock / Jazz / Pop / Classical / off
	Frequency response	30-18000Hz
	Signal to noise ration	>85dB
	Output Power (RMS)	2 x 5mW
Audio Playback		
Compression format	MP3 (8-320 kbps and VBR; Sample rate: 8, 11.025, 16, 22.050, 24, 32, 44.1, 48kHz) WAV WMA (5-192kbps)	
ID3-tag support	Song title and artist name	
Audio Capturing	Built-in microphone	Mono
Storage Media	SA1200 512MB NAND Flash**	
	SA1202 256MB NAND Flash**	
	SA1210 1GB NAND Flash**	
Connectivity	Headphones 3.5mm, USB 2.0 ⁺	
Music transfer	Drag and drop in Windows Explorer	
System Requirements	Windows® 98 SE, Me, 2000 or XP	
	Pentium Class MMX 166MHz processor or better	
	96MB RAM	
	50MB hard drive space	
	Internet connection	
	Microsoft Internet Explorer 5.5 or later	
	Video display card	
Soundcard		
USB port		

* Battery life varies by use and settings.

** 1MB = 1 million bytes; available storage capacity will be less.

1GB = 1 billion bytes; available storage capacity will be less.

Full memory capacity may not be available as some memory will be reserved for the player.

Storage capacity based on 4 minutes per song and 64 kbps WMA.

+ Actual transfer speed may vary based on your operating system and software configuration.

Important safety information

General maintenance

To avoid damage or malfunction:

- Do not expose the player to excessive heat caused by heating equipment or direct sunlight.
- Do not drop your player or allow objects to fall on your player.
- Do not allow your player to be submerged in water. Do not expose headphone socket or battery compartment to water, as water entering the set may cause major damage.
- Do not use any cleaning agents containing alcohol, ammonia, benzene, or abrasives as these may harm the set.
- Active mobile phones in the vicinity may cause interference.
- Backup your files. Please ensure that you retain the original files you have downloaded to your device. Philips is not responsible for any loss of data if the product becomes damaged or not readable / legible.

About operating and storage temperatures

- Operate in a place where temperature is always between 0 and 35°C (32 to 95°F)
- Store in a place where temperature is always between -20 and 45°C (-4 to 113°F)
- Battery life may be shortened in low temperature conditions.

Replacements parts/ accessories

Visit www.philips.com/support or www.philips.com/usasupport (for US residents) or contact our Customer Care Helpline (the telephone number can be found on the first page of this manual) to order replacement parts/ accessories.

Hearing safety

Listen at a moderate volume.

- Using headphones at a high volume can impair your hearing. This product can produce sounds in decibel ranges that may cause hearing loss for a normal person, even for exposure less than a minute. The higher decibel ranges are offered for those that may have already experienced some hearing loss.
- Sound can be deceiving. Over time your hearing “comfort level” adapts to higher volumes of sound. So after prolonged listening, what sounds “normal” can actually be loud and harmful to your hearing. To guard against this, set your volume to a safe level before your hearing adapts and leave it there.



To establish a safe volume level:

- Set your volume control at a low setting.
- Slowly increase the sound until you can hear it comfortably and clearly, without distortion.

Listen for reasonable periods of time:

- Prolonged exposure to sound, even at normally “safe” levels, can also cause hearing loss.
- Be sure to use your equipment reasonably and take appropriate breaks.

Be sure to observe the following guidelines when using your headphones.

- Listen at reasonable volumes for reasonable periods of time.
- Be careful not to adjust the volume as your hearing adapts.
- Do not turn up the volume so high that you can't hear what's around you.
- You should use caution or temporarily discontinue use in potentially hazardous situations.
- Do not use headphones while operating a motorized vehicle, cycling, skateboarding, etc.; it may create a traffic hazard and is illegal in many areas.

Copyright information

All other brands and product names are trademarks of their respective companies or organizations. Unauthorized duplication of any recordings whether downloaded from the Internet or made from audio CDs is a violation of copyright laws and international treaties.

The making of unauthorized copies of copy-protected material, including computer programmes, files, broadcasts and sound recordings, may be an infringement of copyrights and constitute a criminal offence. This equipment should not be used for such purposes.

Disposal of your old product

Your product is designed and manufactured with high quality materials and components, which can be recycled and reused.

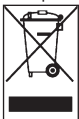

When this crossed-out wheeled bin symbol is attached to a product, it means the product is covered by the European Directive 2002/96/EC.

Please be informed about the local separate collection system for electrical and electronic products.

Please act according to your local rules and do not dispose of your old product with your normal household waste. The correct disposal of your old product will help prevent potential negative consequences to the environment and human health.

Modifications

Modifications not authorized by the manufacturer may void user authority to operate this device.

Notice for USA

Note:

This equipment has been tested and found to comply with the limits for a Class B digital device, pursuant to part 15 of the FCC Rules. These limits are designed to provide reasonable protection against harmful interference in a residential installation. This equipment generates, uses, and can radiate radio frequency energy and, if not installed and used in accordance with the instruction manual, may cause harmful interference to radio communications.

However, there is no guarantee that interference will not occur in a particular installation. If this equipment does cause harmful interference to radio or television reception, which can be determined by turning the equipment off and on, the user is encouraged to try to correct the interference by one or more of the following measures:

- Relocate the receiving antenna.
- Increase the separation between the equipment and receiver.
- Connect the equipment into an outlet on a circuit different from that to which the receiver is connected.
- Consult the dealer or an experienced radio/ TV technician for help.

Notice for Canada

This Class B digital apparatus complies with Canadian ICES-003.

The set complies with the FCC-Rules, Part 15 and with 21 CFR 1040.10. Operation is subject to the following two conditions:

- 1 This device may not cause harmful interference, and
- 2 This device must accept any interference received, including interference that may cause undesired operation.

Notice for the European Union

This product complies with the radio interference requirements of the European Union.





Be responsible
Respect copyrights

Specifications are subject to change without notice.
Trademarks are the property of Koninklijke Philips Electronics N.V.
or their respective owners

2006 © Koninklijke Philips Electronics N.V. All rights reserved.

www.philips.com

wk6391



Printed in China