

Register your product and get support at
www.philips.com/welcome

PET941D



EN User manual 7

FR Mode d'emploi 73

DA Brugervejledning 23

IT Manuale utente 89

DE Benutzerhandbuch 39

NL Gebruiksaanwijzing 105

ES Manual del usuario 57

SV Användarhandbok 121

PHILIPS

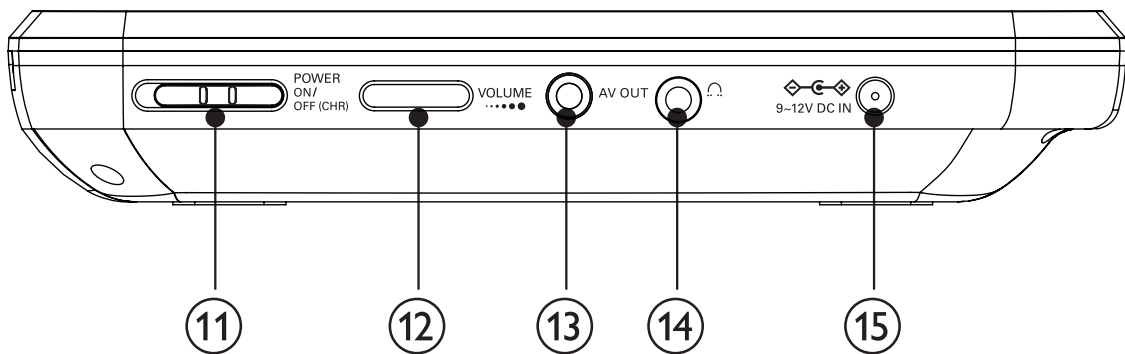
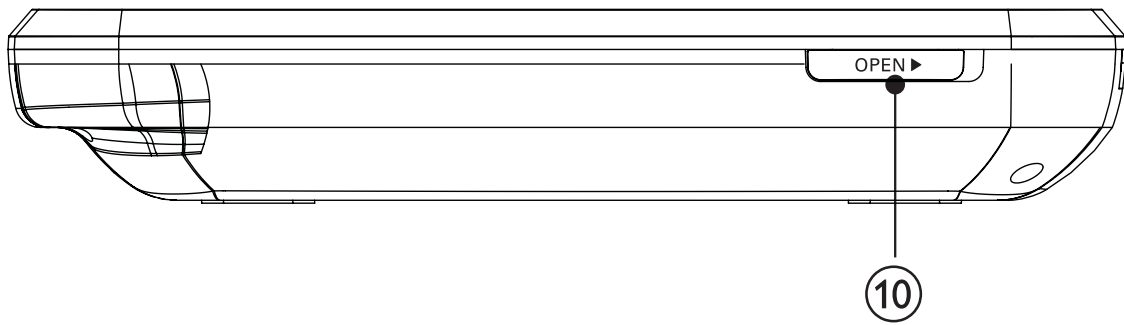
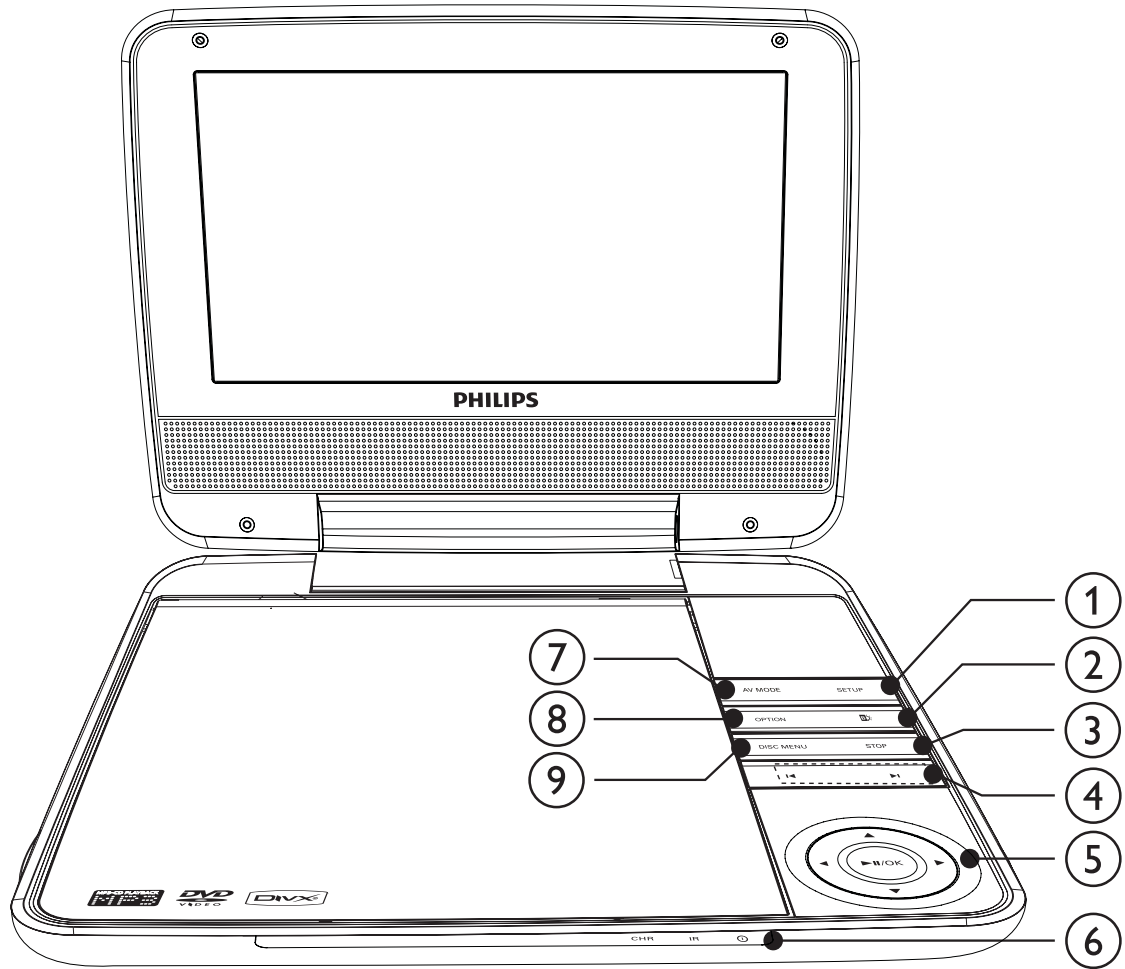

Contents

1	Important	8
	Important safety instructions	8
	Notice	10
<hr/>		
2	Your portable DVD player	12
	Introduction	12
	What's in the box	12
	Overview of the main unit	13
	Overview of the remote control	14
<hr/>		
3	Get started	15
	Charge the battery	15
	Install remote control battery	16
	Connect additional equipment	17
<hr/>		
4	Use your player	18
	Turn on	18
	Select OSD language	18
	Play discs	18
	Play options	19
	Adjust brightness of screen backlight	19
<hr/>		
5	Adjust settings	20
<hr/>		
6	Product information	21
<hr/>		
7	Troubleshooting	22

1 Important

Important safety instructions

- ① Read these instructions.
- ② Keep these instructions.
- ③ Heed all warnings.
- ④ Follow all instructions.
- ⑤ Do not use this apparatus near water.
- ⑥ Clean only with dry cloth.
- ⑦ Do not block any ventilation openings. Install in accordance with the manufacturer's instructions.
- ⑧ Do not install near any heat sources such as radiators, heat registers, stoves, or other apparatus (including amplifiers) that produce heat.
- ⑨ Protect the power cord from being walked on or pinched, particularly at plugs, convenience receptacles, and the point where they exit from the apparatus.
- ⑩ Only use attachments/accessories specified by the manufacturer.
- ⑪ Use only with the cart, stand, tripod, bracket, or table specified by the manufacturer or sold with the apparatus. When a cart is used, use caution when moving the cart/apparatus combination to avoid injury from tip-over.
- ⑫ Unplug this apparatus during lightning storms or when unused for long periods of time.
- ⑬ Refer all servicing to qualified service personnel. Servicing is required when the apparatus has been damaged in any way, such as power-supply cord or plug is damaged, liquid has been spilled or objects have fallen into the apparatus, the apparatus has been exposed to rain or moisture, does not operate normally, or has been dropped.
- ⑭ Apparatus shall not be exposed to dripping or splashing.
- ⑮ Do not place any sources of danger on the apparatus (e.g. liquid filled objects, lighted candles).



- ①6 This product may contain lead and mercury. Disposal of these materials may be regulated due to environmental considerations. For disposal or recycling information, please contact your local authorities or the Electronic Industries Alliance: www.eiae.org.



Warning

- Never remove the casing of this apparatus.
- Never lubricate any part of this apparatus.
- Never place this apparatus on other electrical equipment.
- Keep this apparatus away from direct sunlight, naked flames or heat.
- Never look into the laser beam inside this apparatus.
- Ensure that you always have easy access to the power cord, plug or adaptor to disconnect this apparatus from the power.

Hearing safety

Listen at a moderate volume.

- Using headphones at a high volume can impair your hearing. This product can produce sounds in decibel ranges that may cause hearing loss for a normal person, even for exposure less than a minute. The higher decibel ranges are offered for those that may have already experienced some hearing loss.
- Sound can be deceiving. Over time your hearing 'comfort level' adapts to higher volumes of sound. So after prolonged listening, what sounds 'normal' can actually be loud and harmful to your hearing. To guard against this, set your volume to a safe level before your hearing adapts and leave it there.

To establish a safe volume level:

- Set your volume control at a low setting.
- Slowly increase the sound until you can hear it comfortably and clearly, without distortion.

Listen for reasonable periods of time:

- Prolonged exposure to sound, even at normally 'safe' levels, can also cause hearing loss.
- Be sure to use your equipment reasonably and take appropriate breaks.

Be sure to observe the following guidelines when using your headphones.

- Listen at reasonable volumes for reasonable periods of time.
- Be careful not to adjust the volume as your hearing adapts.
- Do not turn up the volume so high that you can't hear what's around you.
- You should use caution or temporarily discontinue use in potentially hazardous situations. Do not use headphones while operating a motorized vehicle, cycling, skateboarding, etc.; it may create a traffic hazard and is illegal in many areas.

Notice

Any changes or modifications made to this device that are not expressly approved by Philips Consumer Lifestyle may void the user's authority to operate the equipment.

This product complies with the radio interference requirements of the European Community. 

This product complies with the requirements of the following directives and guidelines: 2004/108/EC + 2006/95/EC.

Environmental information

All unnecessary packaging has been omitted. We have tried to make the packaging easy to separate into three materials: cardboard (box), polystyrene foam (buffer) and polyethylene (bags, protective foam sheet.)

Your system consists of materials which can be recycled and reused if disassembled by a specialized company. Please observe the local regulations regarding the disposal of packaging materials, exhausted batteries and old equipment.

Recycling

Your product is designed and manufactured with high quality materials and components, which can be recycled and reused.



When you see the crossed-out wheel bin symbol attached to a product, it means the product is covered by the European Directive 2002/96/EC:



Never dispose of your product with other household waste. Please inform yourself about the local rules on the separate collection of electrical and electronic products. The correct disposal of your old product helps

prevent potentially negative consequences on the environment and human health.

Your product contains batteries covered by the European Directive 2006/66/EC, which cannot be disposed of with normal household waste.

When you see the crossed-out wheel bin symbol with the chemical symbol 'Pb', it means that the batteries comply with the requirement set by the directive for lead:



Please inform yourself about the local rules on separate collection of batteries. The correct disposal of batteries helps prevent potentially negative consequences on the environment and human health.

Always bring your product to a professional to remove the built-in battery.

The making of unauthorized copies of copy-protected material, including computer programs, files, broadcasts and sound recordings, may be an infringement of copyrights and constitute a criminal offence. This equipment should not be used for such purposes.



Recording and playback of material might require consent. See Copyright Act 1956 and The Performer's Protection Acts 1958 to 1972.

"DivX, DivX" Certified, and associated logos are trademarks of DivX, Inc. and are used under license.



This player includes this label:



Norge

Typeskilt finnes på apparatens underside.

Observer: Nettbryteren er sekundert innkoplet. Den innebygde nettdelen er derfor ikke frakoplet nettet så lenge apparatet er tilsluttet nettkontakten.

For å redusere faren for brann eller elektrisk støt, skal apparatet ikke utsettes for regn eller fuktighet.

2 Your portable DVD player





Congratulations on your purchase, and welcome to Philips! To fully benefit from the support that Philips offers, register your product at www.philips.com/welcome.

Introduction

Your portable DVD player plays digital video discs that conform to the universal DVD Video standard. With it, you can play movies with true cinema picture quality and stereo or multi-channel sound (depending on disc and playback set-up).

You can also select sound track, subtitle languages, and different angle of view (again depending on DVD disc). Besides, you can restrict the play of discs that are not suitable for children.

You can play the following discs on the DVD player (including CD-R, CD-RW, DVD±R and DVD±RW):

	DVD-Video
	Video CD
	Audio CD
	MP3 CD
	DivX
	Discs with JPEG files

What's in the box

Check and identify the contents of your package:

- Portable DVD player
- Remote control

- AC power adaptor, DSA-9W-09 F (DVE) or AY4132 (Philips)
- Car adaptor
- AV cables
- User Manual
- Quick Start Guide

Overview of the main unit (see page 4)

① SETUP

- Accesses or exits the setup menu.

②

- Adjusts brightness of the screen backlight.

③

- Stops disc play.

④

- Skips to the previous or next title, chapter, or track.

⑤

- Navigates through the menus.



- Searches backward/forward at different speeds.



- Confirms an entry or selection.
- Starts, pauses or resumes disc play.

⑥ IR/CHR/Ⓚ

- Remote control sensor/Charging indicator/Power indicator.

⑦ AV MODE

- Turns off the front panel display when the player is connected to TV.

⑧ OPTION

- Accesses options relating to the current activity or selection.

⑨ DISC MENU

- For DVD, accesses or exits disc menu.
- For VCD, turns on or off PBC (Playback Control) mode.
- For VCD version 2.0 or SVCD with PBC turned on, returns to the menu.

- ⑩ **OPEN▶**
 - Opens the disc compartment.
 - ⑪ **POWER ON/OFF**
 - Turns on/off DVD player.
 - ⑫ **-VOL +**
 - Increases or decreases volume.
 - ⑬ 
 - Headphone jack
 - ⑭ **AV OUT**
 - Audio/video output jack
 - ⑮ **DC IN**
 - Power supply socket
-

Overview of the remote control (see page 5)

- ① **SETUP**
 - Accesses or exit the setup menu.
- ② **DISPLAY**
 - Displays play information.
- ③ **ZOOM**
 - Zooms in or out.
- ④ **SUB**
 - Selects DVD subtitle language.
- ⑤ **A-B REPEAT**
 - Marks the section for repeat play.**REPEAT 1/ALL**
 - Repeats a chapter/track/title.
- ⑥ **DISC MENU**
 - For DVD, accesses or exits disc menu.
 - For VCD, turns on or off PBC (Playback Control) mode.
- ⑦ **AUDIO**
 - For DVD, selects an audio language.
 - For VCD, selects an audio mode.
- ⑧ **ANGLE**
 - Selects a different viewing angle of a DVD.

- ⑨ 0 - 9
 - Inputs numbers.
- ⑩ ■
 - Stops disc play.
- ⑪ 
 - Adjusts brightness of the screen backlight.
- ⑫ ▲, ▼, ◀, ▶
 - Moves cursor up/down/left/right.
- ◀◀, ▶▶
 - Searches backward or forward at different speeds.
- ▶||/OK
 - Confirms an entry or selection.
 - Starts, pauses or resumes disc play.
- ⑬ ◀, ▶
 - Skips to previous/next chapter, track or title.

3 Get started



Caution

- Use the controls only as stated in this user manual.

Always follow the instructions in this chapter in sequence.

If you contact Philips, you will be asked for the model and serial number of your player. The model number and serial number are on the bottom of your player. Write the numbers here:

Model No. _____

Serial No. _____

Charge the battery



Caution

- Risk of product damage! Ensure that the power supply voltage corresponds to the voltage printed on the bottom of the player.
- Use only the supplied AC adaptor to charge the battery.



Note

- The type plate is located on the bottom of the player.
- You can only charge the player when it is in power-off mode.

- 1 Slide the **POWER ON/OFF** switch to **OFF** position.
- 2 Connect the supplied AC adaptor to the player and to the AC outlet.

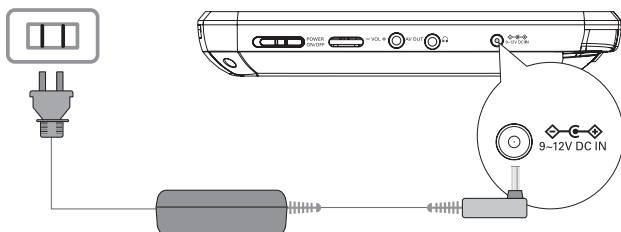

- ↳ The charge indicator turns on. It takes about 7 hours to fully charge the battery.
- ↳ When the battery is fully charged, the charge indicator turns off.

Install remote control battery



Caution

- Risk of explosion! Keep batteries away from heat, sunshine or fire. Never discard batteries in fire.
- Risk of decreased battery life! Never mix different brands or types of batteries.
- Risk of product damage! When the remote control is not used for long periods, remove the batteries.
- Perchlorate Material - special handling may apply. See www.dtsc.ca.gov/hazardouswaste/perchlorate.

For first-time use:

- 1 Remove the protective tab to activate the remote control battery.

To replace the remote control battery:

- 1 Open the battery compartment.
- 2 Insert 1 CR2025 battery with correct polarity (+/-) as indicated.
- 3 Close the battery compartment.

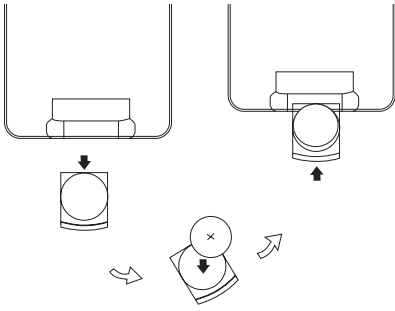

Connect additional equipment



Caution

- Turn off your player before connecting to any additional equipment.

You can connect the player to a TV or an amplifier to enjoy DVDs or Karaoke.

Match the color of the AV cables (the AV cable connected to TV is not supplied) with the jacks: the yellow cable is for the yellow video jack, the red/white cable is for the red/white audio jacks.

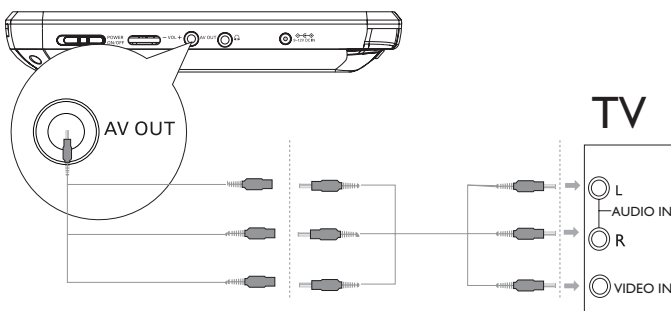

Tip

- To conserve energy, press **AV MODE** to turn off the front panel display.

4 Use your player

Turn on

Slide the **POWER ON/OFF** switch to the **ON** position.

↳ The  indicator turns on.

Select OSD language

You can choose a different language for the on-screen display text.

- 1 Press **SETUP**.
↳ The setup menu appears.



- 2 Select **[-- General Setup Page --]** > **[OSD Language]**.
 - 3 Press **▶** to select an option.
 - 4 Press **▶||/OK** to confirm.
 - 5 Press **SETUP** to exit.
-

Play discs

- 1 Slide **OPEN▶** on the player.
- 2 Insert the disc with label side facing up.
- 3 Push down to close the disc compartment.
↳ Play starts automatically. If not, press **▶||/OK**.
 - If a menu appears, select an item, then press **▶||/OK** to start play.
 - To pause, press **▶||/OK**. Press again to resume play.
 - To stop, press **■** twice.
 - To select the previous/next item, press **◀** or **▶**.
 - To start search within video/audio, press **◀** or **▶** once or more.

Play options

1 During play, press **OPTION** to select some play options.

For DVD

- [Audio]
- [Subtitle]
- [Repeat]
- [Time Disp.]

For VCD

- [Audio]
- [Repeat]
- [Time Disp.]

For audio CDs

- [Repeat One]
- [Repeat Folder]
- [Repeat Off]

For JPEG CDs

- [Repeat One]
- [Repeat Folder]

2 Follow the on-screen instructions.

Adjust brightness of screen backlight



Note

- You can adjust brightness of the screen backlight to match lighting conditions.

During play, press **Brightness** repeatedly to select an option.

- [Bright]
- [Normal]
- [Dim]



Tip

- To achieve the longest playtime, select [Dim].
- To achieve the best view, select [Bright].

5 Adjust settings

To maximize your play experience, use **SETUP** to fine tune your settings.

- 1 Press **SETUP**.
↳ The setup menu is displayed.
- 2 Press **▲▼** to select an option and press **▶II/OK** to confirm.

[-- General Setup Page --]	
[OSD Language]	Select on-screen display language.
[Screen Saver]	Activate/deactivate screen saver.
[Resume]	Select whether to start play from the point where it was last stopped.
[Angle Mark]	select angle mark display options.
[-- Display Setup Page --]	
[Brightness]	Adjust screen brightness.
[Contrast]	Adjust screen contrast.
[Screen Display]	Select display ratio.
[-- Battery Life Setup Page --]	
[LCD Backlight]	Adjust the default brightness level of screen backlight.
[-- Preference Page --]	
[Audio]	Select audio language.
[DVD Subtitle]	Select DVD subtitle language.
[DivX Subtitle]	Select DivX subtitle language.
[Disc Menu]	Select disc menu language.
[Parental]	Select parental level.
[Password]	Change password (3308 by default).
[DivX VOD]	Get DivX registration code.
[Default]	Restore original settings.

3 Press ◀ to go back to previous menu level.

4 Press **SETUP** to exit.

6 Product information



Note

- Product information is subject to change without prior notice.

Dimensions	240 x 178 x 40 mm
Weight	1.1 kg
Power supply	Input: 100-240V 50/60Hz 0.3A Output: DC 9V 1A
Power consumption	9 W
Operating temperature range	0-45°C
Laser wavelength	650 nm
Video system	NTSC & PAL
Frequency response	20Hz-20KHz ± 1dB
Signal/noise ratio	≥ 80 dB
Audio distortion + noise	≤ -80 (1KHz)
Channel separation	≥ 80 dB
Dynamic range	≥ 80 dB
Audio out (analog audio)	Output level: 2V ± 10%
Load impedance	10 KΩ
Video out	Output level: 1Vp - p ± 20%
Load impedance	75 Ω

7 Troubleshooting



Warning

- Risk of electric shock. Never remove the casing of the player.

To keep the warranty valid, never try to repair the system yourself. If you encounter problems when using the player, check the following points before requesting service. If the problem remains unsolved, register your player and get support at www.philips.com/welcome.

No power

- Ensure that both plugs of the mains cord are properly connected.
- Ensure that there is power at the AC outlet.
- Check if the built-in battery is drained.

No sound

- Ensure that the AV cable is connected correctly.

Distorted picture

- Clean the disc. With a clean, soft, lint-free cloth, wipe the disc outwards from the center.
- Make sure that the video output format of the disc is compatible with the TV.
- Change the video output format to match your TV or program.
- The LCD is manufactured using high precision technology. You may, however, see tiny black points and/or bright points (red, blue, green) that continuously appear on the LCD. This is a normal result of the manufacturing process and does not indicate a malfunction.

Cannot play disc

- Ensure the disc label is upwards.
- Clean the disc. With a clean, soft, lint-free cloth, wipe the disc outwards from the center.
- Check if the disc is defective by trying another disc.

No response to the remote control

- Ensure that the path between the remote control and the player is clear from obstacles.
- From a close distance, point the remote control directly at the player.
- Replace the remote control batteries.
- The function does not work for this disc. Refer to the disc instructions.

The player feels warm

- When the player is in use for a long period of time, its surface will be heated. This is normal.

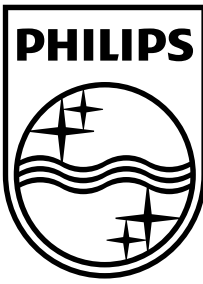

© 2009 Koninklijke Philips Electronics N.V.

All rights reserved.

PET941D_12_UM_V1.2

