

Always there to help you

Register your product and get support at
www.philips.com/welcome

PD9016P/37



User manual 1

Mode d'emploi 51

Manual del usuario 25

PHILIPS

Contents

| | | |
|----------|--------------------------|----------|
| 1 | Safety and notice | 3 |
| | Safety | 3 |
| | Compliance | 6 |
| | Care of the environment | 7 |
| | Copyright | 7 |

| | | |
|----------|---------------------------------|----------|
| 2 | Your portable DVD player | 9 |
| | What's in the box | 9 |
| | Overview of the main unit | 10 |

| | | |
|----------|---------------------|-----------|
| 3 | Get started | 12 |
| | Prepare | 12 |
| | Connect power | 13 |
| | Switch on/off | 14 |
| | Select OSD language | 14 |

| | | |
|----------|------------------------------|-----------|
| 4 | Use your player | 15 |
| | Play discs | 15 |
| | Connect additional equipment | 18 |

| | | |
|----------|------------------------|-----------|
| 5 | Adjust settings | 20 |
|----------|------------------------|-----------|

| | | |
|----------|----------------------------|-----------|
| 6 | Product information | 21 |
|----------|----------------------------|-----------|

| | | |
|----------|------------------------|-----------|
| 7 | Troubleshooting | 22 |
|----------|------------------------|-----------|

Register online at www.philips.com/welcome today to
get the very most from your purchase.

Registering your model with PHILIPS makes you eligible for all of the valuable benefits listed below, so don't miss out.
Register online at www.philips.com/welcome to ensure:

*Product Safety Notification

By registering your product, you'll receive notification - directly from the manufacturer.

*Additional Benefits

Registering your product guarantees that you'll receive all of the privileges to which you're entitled, including special money-saving offers.

PHILIPS

*Congratulations on your purchase,
and welcome to the "family!"*

Dear PHILIPS product owner:

Thank you for your confidence in PHILIPS. You've selected one of the best-built, best-backed products available today. We'll do everything in our power to keep you happy with your purchase for many years to come.

As a member of the PHILIPS "family," you're entitled to protection by one of the most comprehensive warranties in the industry. What's more, your purchase guarantees you'll receive all the information and special offers for which you qualify, plus easy access to accessories from our convenient home shopping network.

Most importantly, you can count on our uncompromising commitment to your total satisfaction.

All of this is our way of saying welcome - and thanks for investing in a PHILIPS product.

P.S. To get the most from your PHILIPS purchase, be sure to register online at:

www.philips.com/welcome

Know these safety symbols



⚡ This "bolt of lightning" indicates unsulated material within your unit may cause an electrical shock. For the safety of everyone in your household, please do not remove product covering.

! The "exclamation point" calls attention to features for which you should read the enclosed literature closely to prevent operating and maintenance problems.

WARNING: To reduce the risk of fire or electric shock, this apparatus should not be exposed to rain or moisture and objects filled with liquids, such as vases, should not be placed on this apparatus.

CAUTION: To prevent electric shock, match wide blade of plug to wide slot, fully insert.

ATTENTION: Pour éviter les choc électriques, introduire la lame la plus large de la fiche dans la borne correspondante de la prise et pousser jusqu'au fond.

For Customer Use

Enter below the Serial No. which is located on the rear of the cabinet. Retain this information for future reference.

Model No. _____
Serial No. _____

PHILIPS

Visit our World Wide Web Site at <http://www.philips.com/welcome>

1 Safety and notice

Read and understand all instructions before you use this product. If damage is caused by failure to follow the instructions, the warranty does not apply.

Safety



This 'bolt of lightning' indicates uninsulated material within the device may cause an electrical shock. For the safety of everyone in your household, please do not remove the covering.



The 'exclamation mark' calls attention to features for which you should read the enclosed literature closely to prevent operating and maintenance problems.

WARNING: To reduce the risk of fire or electric shock, the device should not be exposed to rain or moisture and objects filled with liquids, such as vases, should not be placed on the device.

CAUTION: To prevent electric shock, fully insert the plug. (For regions with polarized plugs: To prevent electric shock, match wide blade to wide slot.)

Important Safety Instructions

- ① Read these instructions.
- ② Keep these instructions.
- ③ Heed all warnings.

- ④ Follow all instructions.
- ⑤ Do not use this apparatus near water.
- ⑥ Clean only with dry cloth.
- ⑦ Do not block any ventilation openings. Install in accordance with the manufacturer's instructions.
- ⑧ Do not install near any heat sources such as radiators, heat registers, stoves, or other apparatus (including amplifiers) that produce heat.
- ⑨ Do not defeat the safety purpose of the polarized or grounding-type plug. A polarized plug has two blades with one wider than the other. A grounding type plug has two blades and a third grounding prong. The wide blade or the third prong are provided for your safety. If the provided plug does not fit into your outlet, consult an electrician for replacement of the obsolete outlet.
- ⑩ Protect the power cord from being walked on or pinched, particularly at plugs, convenience receptacles, and the point where they exit from the apparatus.
- ⑪ Only use attachments/accessories specified by the manufacturer.
- ⑫ Use only power supplies listed in the user manual.
- ⑬ Use only with the cart, stand, tripod, bracket, or table specified by the manufacturer or sold with the apparatus. When a cart is used, use caution when moving the cart/apparatus combination to avoid injury from tip-over.



- ⑭ Unplug this apparatus during lightning storms or when unused for long periods of time.
- ⑮ Refer all servicing to qualified service personnel. Servicing is required when the apparatus has been damaged in any way, such as power-supply cord or plug is damaged, liquid has been spilled or objects have fallen into the apparatus, the apparatus has been exposed to rain or moisture, does not operate normally, or has been dropped.

- ⑩ Apparatus shall not be exposed to dripping or splashing.
- ⑪ Do not place any sources of danger on the apparatus (e.g. liquid filled objects, lighted candles).
- ⑫ This product may contain lead and mercury. Disposal of these materials may be regulated due to environmental considerations. For disposal or recycling information, please contact your local authorities or the Electronic Industries Alliance: www.eiae.org.

Hearing safety

Listen at a moderate volume.

- Using headphones at a high volume can impair your hearing. This product can produce sounds in decibel ranges that may cause hearing loss for a normal person, even for exposure less than a minute. The higher decibel ranges are offered for those that may have already experienced some hearing loss.
- Sound can be deceiving. Over time your hearing 'comfort level' adapts to higher volumes of sound. So after prolonged listening, what sounds 'normal' can actually be loud and harmful to your hearing. To guard against this, set your volume to a safe level before your hearing adapts and leave it there.

To establish a safe volume level:

- Set your volume control at a low setting.
- Slowly increase the sound until you can hear it comfortably and clearly, without distortion.

Listen for reasonable periods of time:

- Prolonged exposure to sound, even at normally 'safe' levels, can also cause hearing loss.
- Be sure to use your equipment reasonably and take appropriate breaks.

Be sure to observe the following guidelines when using your headphones.

- Listen at reasonable volumes for reasonable periods of time.
- Be careful not to adjust the volume as your hearing adapts.
- Do not turn up the volume so high that you can't hear what's around you.
- You should use caution or temporarily discontinue use in potentially hazardous situations. Do not use headphones while operating a motorized vehicle, cycling, skateboarding, etc.; it may create a traffic hazard and is illegal in many areas.

Compliance

Notice for the USA

This equipment has been tested and found to comply with the limits for a Class B digital device, pursuant to part 15 of the FCC Rules. These limits are designed to provide reasonable protection against harmful interference in a residential installation. This equipment generates, uses, and can radiate radio frequency energy and, if not installed and used in accordance with the instruction manual, may cause harmful interference to radio communications.

However, there is no guarantee that interference will not occur in a particular installation. If this equipment does cause harmful interference to radio or television reception, which can be determined by turning the equipment off and on, the user is encouraged to try to correct the interference by one or more of the following measures:

- Relocate the receiving antenna.
- Increase the separation between equipment and receiver.
- Connect the equipment into an outlet on a circuit different from that to which the receiver is connected.
- Consult the dealer or an experienced radio/TV technician for help.

The set complies with the FCC-Rules, Part-15 and with 21 CFR 1040.10.

Operation is subject to the following two conditions:

- This device may not cause harmful interference, and
- This device must accept any interference received, including interference that may cause undesired operation.

Notice for Canada

This Class B digital apparatus complies with Canadian ICES-003.

This apparatus includes this label:



Note

- The type plate is located on the back of the product.

Any changes or modifications made to this product that are not expressly approved by Philips Consumer Lifestyle may void the user's authority to operate the equipment.

Care of the environment

Environmental information

All unnecessary packaging has been omitted. We have tried to make the packaging easy to separate into three materials: cardboard (box), polystyrene foam (buffer) and polyethylene (bags, protective foam sheet.)

Your system consists of materials which can be recycled and reused if disassembled by a specialized company. Please observe the local regulations regarding the disposal of packaging materials, and old equipment.

Recycling the product and the built-in battery

Your product is designed and manufactured with high quality materials and components, which can be recycled and reused.

Never dispose of your product with other household waste. Please inform yourself about the local rules on the separate collection of electrical and electronic products and batteries.

The correct disposal of these products helps prevent potentially negative consequences on the environment and human health.

Please visit www.recycle.philips.com for additional information on a recycling center in your area.

Copyright



Be responsible
Respect copyrights

This item incorporates copy protection technology that is protected by U.S. patents and other intellectual property rights of Rovi Corporation. Reverse engineering and disassembly are prohibited.

Specifications are subject to change without notice. Trademarks are the property of Koninklijke Philips Electronics N.V or their respective owners. Philips reserves the right to change products at any time without being obliged to adjust earlier supplies accordingly.



Manufactured under license from Dolby Laboratories. Dolby and the double-D symbol are trademarks of Dolby Laboratories.

2 Your portable DVD player

You can play the following discs on the DVD player (including CD-R, CD-RW, DVD±R and DVD±RW):

- DVD-Video
- Video CD
- Audio CD
- MP3 CD
- Discs with JPEG files

What's in the box

Check and identify the contents of your package:

- Main unit x 2
- AC power adaptor x 2, ASUC12A-090080 (Philips)
- Car adaptor x 1
- AV cable x 2
- Mounting strap x 2
- User Manual x 1

Overview of the main unit

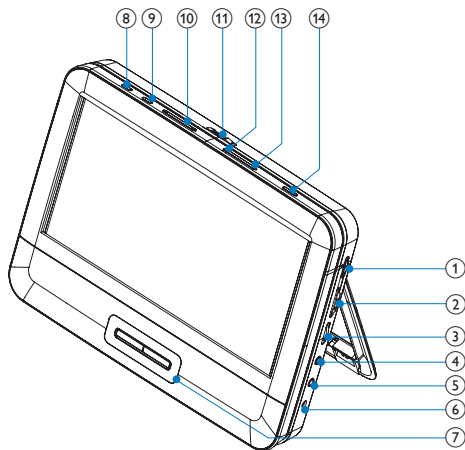

- ① **DVD/AV IN**
 - Switch to DVD/AV IN mode.
- ② **ON/OFF**
 - Turns on/off DVD player.
- ③ **VOL+/VOL-**
 - Increases or decreases volume.
- ④ 
 - Headphone jack.
- ⑤ **AV OUT**
 - Audio/video output jack.
- ⑥ **9-12V DC IN**
 - Power supply socket.

- ⑦ ▲, ▼, ◀, ▶
- Navigates menus.
- ◀◀ ▶▶
- Searches backward/forward at different speeds.
- /OK
- Confirms an entry or selection.
 - Starts, pauses or resumes disc play.
-
- Stops disc play.
- ⑧ **BRIGHTNESS**
- Adjusts screen brightness.
- ⑨ **SETUP**
- Accesses or exits the setup menu.
- ⑩ **◀, ▶**
- Skips to the previous or next title, chapter, or track.
- ⑪ **OPEN ▶**
- Opens the disc compartment.
- ⑫ **DISC MENU**
- For DVD, accesses or exits disc menu.
 - For VCD, turns on or off PBC (Playback Control) mode.
 - For VCD version 2.0 or SVCD with PBC turned on, returns to the menu.
- ⑬ **OPTIONS**
- Accesses options relating to the current activity or selection.
- ⑭ **AV MODE**
- Switches between the PAL and NTSC mode.
 - Turns off the front panel display when the player is connected to TV.

3 Get started



Caution

- Use the controls only as stated in this user manual.
- Always follow the instructions in this chapter in sequence.

If you contact Philips, you will be asked for the model and serial number of your apparatus. The model number and serial number are on the back of the apparatus. Write the numbers here:

Model No. _____

Serial No. _____

Prepare

Mount the unit in your car

To use the player in your car, attach the main unit and the second screen to the back of the front seat headrests.

1

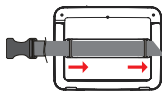

2

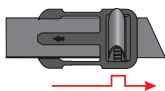

3

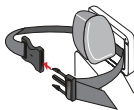

4

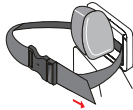

- 1 Pull the strap through the loops on the back of the main unit.
- 2 Hold the buckle with the marked arrow facing you, then attach the buckle to the strap.
- 3 Position the main unit at the back of the headrest, then fasten the buckle.
- 4 Pull the strap to secure the main unit to the headrest.
 - To attach the second screen, repeat the above steps.

Connect power

Connect through the car adaptor



Caution

- Risk of product damage! Ensure that the power supply voltage corresponds to the voltage pointed on the back or the underside of the player.
- Risk of electric shock! When you unplug the AC adaptor, always pull the plug from the socket. Never pull the cable.

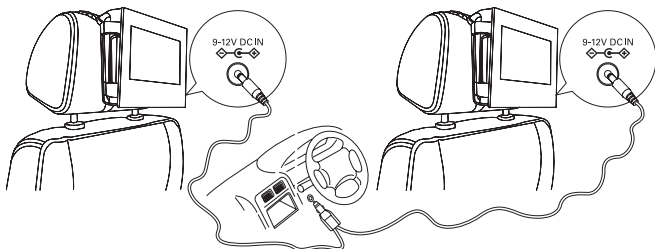

- 1 Connect one end of the double-connector end of the AC cable to the DC IN jacks on the main units.
- 2 Connect the one-connector end to the car cigarette lighter socket.

Connect through the AC adaptor

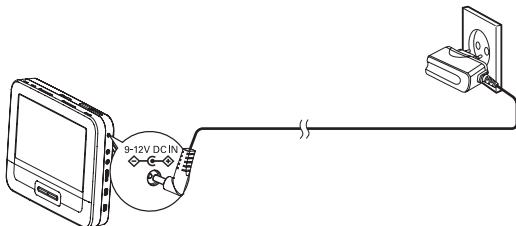

- 1 Connect the AC adaptor cable to:
 - the **DC IN** jack on the main unit.
 - the power outlet.

Switch on/off

- 1 Slide the **ON/OFF** switch on the main units to the **ON** position.
- 2 To switch off the player, slide the **ON/OFF** switch to the **OFF** position.

Select OSD language

You can choose a different language for the on-screen display text.

- 1 Slide the **DVD/AV IN** switch to **DVD**.
- 2 Press **SETUP**.
 - ↳ The setup menu is displayed.

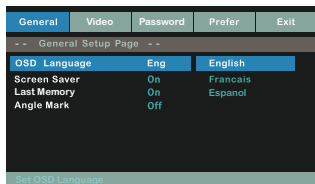

- 3 Go to [-- General Setup Page --] > [OSD Language] (on-screen display language).
- 4 Press ▲ / ▼ to select a language.
- 5 Press ► || /OK to confirm.
- 6 Press **SETUP** to exit.

4 Use your player

Play discs

- 1 Slide the **DVD/AV IN** switch to **DVD**.
- 2 Slide **OPEN** ► on the main unit.
- 3 Insert the disc with label side facing you.
- 4 Push down to close the disc compartment.
 - ↳ Play starts automatically. If not, press ►||/OK.
 - If a menu is displayed, select an item, and then press ►||/OK to start play.
 - To pause, press ►||/OK. Press again to resume play.
 - To stop, press ■ twice.
 - To select the previous/next item, press ◀ or ▶.
 - To start search within video/audio, press ◀◀ or ▶▶ once or more.

Play options

Select audio language

For DVDs that contain two or more subtitle languages,

- 1 Press **OPTIONS**.
 - ↳ The option menu is displayed.
- 2 Select **[Audio]**.
- 3 Press ◀◀/▶▶ to select a language.
- 4 Press ►||/OK to confirm.

Select subtitle language

For DVDs that contain two or more subtitle languages,

- 1 Press **OPTIONS**.
 - ↳ The option menu is displayed.

- 2 Select **[Subtitle]**.
- 3 Press **◀◀ / ▶▶** to select a subtitle.
- 4 Press **▶|| / OK** to confirm.

Repeat

During play, you can select different repeat options.

- 1 Press **OPTIONS**.
↳ The option menu is displayed.
- 2 Select **[Repeat]**, then press navigation keys to select a repeat option.
For DVD
 - **[Repeat Off]**: switch off the repeat mode
 - **↻ [Chapter]**: repeat the current chapter
 - **↻ [Title]**: repeat the current title or track
 - **↻ [All]**: repeat all titles on the discFor VCD/MP3/CD/DivX
 - **[Repeat Off]**: switch off the repeat mode
 - **↻ [Track]**: repeat the current track
 - **↻ [All]**: repeat all the tracks
- 3 Select an option, then press **▶|| / OK** to confirm.
- 4 Press **OPTIONS** to exit.



Tip

- For VCDs, if PBC is on, you cannot repeat items.

Display play time

During play, press **OPTIONS**.

- ↳ The option menu is displayed.
- 1 Select **[Time Disp.]**, then press **◀◀ / ▶▶** to select a display option.
↳ The display options are different depending on the disc type.

| Option | Action |
|-------------------------------------|--|
| [Title Elapsed] / [Chapter Elapsed] | Displays DVD title or chapter elapsed play time. |
| [Title Remain] / [Chapter Remain] | Displays DVD title or chapter remaining play time. |
| [Single Elapsed] / [Total Elapsed] | Displays VCD/SVCD disc or track elapsed play time. |
| [Single Remain] / [Total Remain] | Displays VCD/SVCD disc or track remaining play time. |

2 Select an option, then press **▶||/OK**.

Select audio mode

When you play VCDs, you can select an audio mode.

- 1 Press **OPTIONS**.
↳ The option menu is displayed.
- 2 Select **[Audio]**.
- 3 Press **◀◀ / ▶▶** to select audio channel: **[Stereo]**, **[Mono Left]** or **[Mono Right]**.

Adjust brightness of screen backlight



Note

- You can adjust brightness of the screen backlight to match lighting conditions.

During play, press **BRIGHTNESS** repeatedly to select an option.

- **[High]**
- **[Normal]**
- **[Dim]**

Connect additional equipment

Connect the dual DVD players



Caution

- Turn off the players before you connect the dual DVD players.

You can view the same content on dual screens by connecting the dual DVD players together.

To view the same display on both DVD players,

- 1 On one player: Slide the **DVD/AV IN** switch to **DVD**, and then inset a disc.
- 2 On the other player: Slide the **DVD/AV IN** switch to **AV IN**.

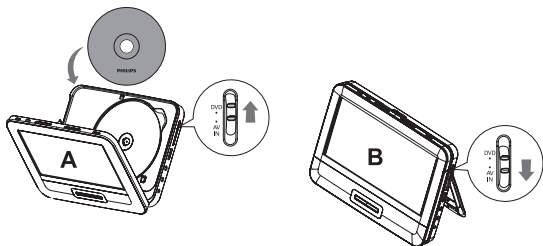

- 3 Connect the supplied AV cable to the **AV OUT** jacks of each DVD player.

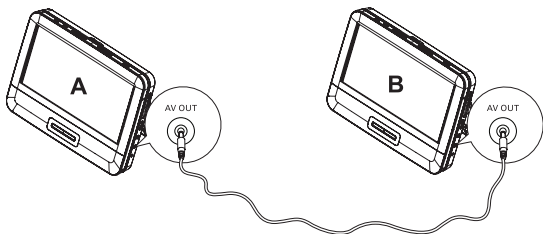

- 4 Switch **ON/OFF** to the **ON** position on both players..
 ↳ The play starts simultaneously on both players.



Note

- Do not connect the AV cable to the headphone jack.

Connect to a TV



Caution

- Turn off your player before connecting to any additional equipment.

You can connect the player to a TV or an amplifier to enjoy DVDs.
 Match the color of the AV cables (the AV cable connected to TV is not supplied) with the jacks:

- the yellow cable is for the yellow video jack
- the red/white cable is for the red/white audio jack.

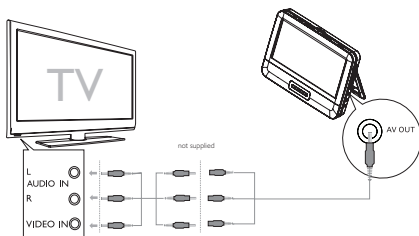

Tip

- To conserve energy, press **AV MODE** to turn off the front panel display.

5 Adjust settings

To maximize your play experience, use **SETUP** to fine tune your settings.

- 1 In DVD mode, press **SETUP**.
↳ The setup menu is displayed.
- 2 Use navigation keys to select an option and press **▶||/OK** to confirm.

[-- General Setup Page --]

| | |
|----------------|--|
| [OSD Language] | Select an onscreen display language. |
| [Screen Saver] | Activate/deactivate the screen saver. |
| [Last Memory] | Select whether to start play from the point where the video was stopped last time. |
| [Angle Mark] | Select angle mark display options. |

[-- Video Setup Page --]

| | |
|---------------|--|
| [Brightness] | Adjust screen brightness. |
| [Contrast] | Adjust screen contrast. |
| [LCD display] | Select a display ratio. |
| [TV Type] | Select a TV standard. |
| [Password] | |
| [Password] | Change the password (3308 by default). |

[-- Preference Setup Page --]

| | |
|-------------|---------------------------------|
| [Audio] | Select an audio language. |
| [Subtitle] | Select a DVD subtitle language. |
| [Disc Menu] | Select a disc menu language. |
| [Parental] | Select a parental level. |
| [Default] | Restore original settings. |

- 3 Press **◀◀** to go back to previous menu level.
- 4 Press **SETUP** to exit.

6 Product information



Note

- Product information is subject to change without prior notice.

Dimensions

- Main unit (each) 240 x 183 x 38 mm

Weight

- Main unit (each) 0.9 kg

AC power adaptor ASUC12A-090080 (Philips)

Power supply Input: 100-240V~ 50/60Hz 0.3A
Output: DC 9-12V $\bar{\bar{=}}$ 0,8A

Power consumption 7.2 W

Operating temperature range 0-45°C

Laser wavelength 650 nm

Video output

Format PAL & NTSC

Output level 1V_p - p \pm 20%

Load impedance 75 Ω

Audio line out

Audio out (analog audio) Output level: 2V \pm 10%

Load impedance 10 K Ω

Audio distortion + noise \leq -80 (1KHz)

Frequency response 20Hz-20KHz \pm 1dB

Signal/noise ratio \geq 80 dB

Channel separation \geq 80 dB

Dynamic range \geq 80 dB

7 Troubleshooting



Warning

- Risk of electric shock. Never remove the casing of the player.

To keep the warranty valid, never try to repair the system yourself. If you encounter problems when using the player, check the following points before requesting service. If the problem remains unsolved, register your player and get support at www.philips.com/support

No power

- Ensure that both plugs of the mains cord are properly connected.
- Ensure that there is power at the car cigarette lighter or AC outlet.

No sound

- Adjust the volume.
- Ensure that the AV cable is connected correctly.

Distorted picture

- Clean the disc. With a clean, soft, lint-free cloth, wipe the disc outwards from the center.
- Make sure that the video output format of the disc is compatible with the TV.
- Change the video output format to match your TV or program.
- The LCD is manufactured using high precision technology. You may, however, see tiny black points and/or bright points (red, blue, green) that continuously appear on the LCD. This is a normal result of the manufacturing process and does not indicate a malfunction.

Cannot play disc

- Ensure the disc label is upwards.
- Clean the disc. With a clean, soft, lint-free cloth, wipe the disc outwards from the center.
- Check if the disc is defective by trying another disc.

No sound or no video on dual screen

- Ensure the AV cable is connected to the **AV OUT** jack of the player.
- Ensure the DVD/AV IN is switched to the correct position for both players (see 'Connect the dual DVD players' on page 19).

The player feels warm

- When the player is in use for a long period of time, its surface will be heated. This is normal.

PHILIPS LIMITED WARRANTY ONE (1) YEAR

WARRANTY COVERAGE:

PHILIPS warranty obligation is limited to the terms set forth below.

WHO IS COVERED:

Philips warrants the product to the original purchaser or the person receiving the product as a gift against defects in materials and workmanship as based on the date of original purchase ("Warranty Period") from an Authorized Dealer. The original sales receipt showing the product name and the purchase date from an authorized retailer is considered such proof.

WHAT IS COVERED:

The Philips warranty covers new products if a defect in material or workmanship occurs and a valid claim is received by Philips within the Warranty Period. At its option, Philips will either (1) repair the product at no charge, using new or refurbished replacement parts, or (2) exchange the product with a product that is new or which has been manufactured from new, or serviceable used parts and is at least functionally equivalent or most comparable to the original product in Philips current inventory, or (3) refund the original purchase price of the product. Philips warrants replacement products or parts provided under this warranty against defects in materials and workmanship from the date of the replacement or repair for ninety (90) days or for the remaining portion of the original product's warranty, whichever provides longer coverage for you. When a product or part is exchanged, any replacement item becomes your property and the replaced item becomes Philips' property. When a refund is given, your product becomes Philips' property.

Note: Any product sold and identified as refurbished or renewed carries a ninety (90) day limited warranty.

Replacement product can only be sent if all warranty requirements are met. Failure to follow all requirements can result in delay.

WHAT IS NOT COVERED - EXCLUSIONS AND LIMITATIONS:

This Limited Warranty applies only to the new products manufactured by or for Philips that can be identified by the trademark, trade name, or logo affixed to it. This Limited Warranty does not apply to any non-Philips hardware product or any software, even if packaged or sold with the product. Non-Philips manufacturers, suppliers, or publishers may provide a separate warranty for their own products packaged with the bundled product.

Philips is not liable for any damage to or loss of any programs, data, or other information stored on any media contained within the product, or any non-Philips product or part not covered by this warranty. Recovery or reinstallation of programs, data or other information is not covered under this Limited Warranty.

This warranty does not apply (a) to damage caused by accident, abuse, misuse, neglect, misapplication, or non-Philips product, (b) to damage caused by service performed by anyone other than Philips or Philips Authorized Service Location, (c) to a product or a part that has been modified without the written permission of

Philips, or (d) if any Philips serial number has been removed or defaced, or (e) product, accessories or consumables sold "AS IS" without warranty of any kind by including refurbished Philips product sold "AS IS" by some retailers.

This Limited Warranty does not cover:

- Shipping charges to return defective product to Philips.
- Labor charges for installation or setup of the product, adjustment of customer controls on the product, and installation or repair of antenna/signal source systems outside of the product.
- Product repair and/or part replacement because of improper installation or maintenance, connections to improper voltage supply, power line surge, lightning damage, retained images or screen markings resulting from viewing fixed stationary content for extended periods, product cosmetic appearance items due to normal wear and tear, unauthorized repair or other cause not within the control of Philips.
- Damage or claims for products not being available for use, or for lost data or lost software.
- Damage from mishandled shipments or transit accidents when returning product to Philips.
- A product that requires modification or adaptation to enable it to operate in any country other than the country for which it was designed, manufactured, approved and/or authorized, or repair of products damaged by these modifications.
- A product used for commercial or institutional purposes (including but not limited to rental purposes).
- Product lost in shipment and no signature verification receipt can be provided.
- Failure to operate per Owner's Manual.

TO OBTAIN ASSISTANCE IN THE U.S.A., CANADA, PUERTO RICO, OR U.S. VIRGIN ISLANDS...

Contact Philips Customer Care Center at:
1-866-309-0845

REPAIR OR REPLACEMENT AS PROVIDED UNDER THIS WARRANTY IS THE EXCLUSIVE REMEDY FOR THE CONSUMER. PHILIPS SHALL NOT BE LIABLE FOR ANY INCIDENTAL OR CONSEQUENTIAL DAMAGES FOR BREACH OF ANY EXPRESS OR IMPLIED WARRANTY ON THIS PRODUCT. EXCEPT TO THE EXTENT PROHIBITED BY APPLICABLE LAW, ANY IMPLIED WARRANTY OF MERCHANTABILITY OR FITNESS FOR A PARTICULAR PURPOSE ON THIS PRODUCT IS LIMITED IN DURATION TO THE DURATION OF THIS WARRANTY.

Some states do not allow the exclusions or limitation of incidental or consequential damages, or allow limitations on how long an implied warranty lasts, so the above limitations or exclusions may not apply to you.

This warranty gives you specific legal rights. You may have other rights which vary from state/province to state/province.

P&F USA, Inc. PO Box 2248, Alpharetta, GA 30023-2248

3140 035 51091

P&F USA Inc.
PO Box 2248
Alpharetta, GA 30023-2248
Phone 1 866 309 0845

Meet Philips at the Internet
<http://www.philips.com/welcome>



Specifications are subject to change without notice
© 2013 Koninklijke Philips Electronics N.V.
All rights reserved.

PD9016P_37_UM_V1.0

