

# Quick Start Guide

1

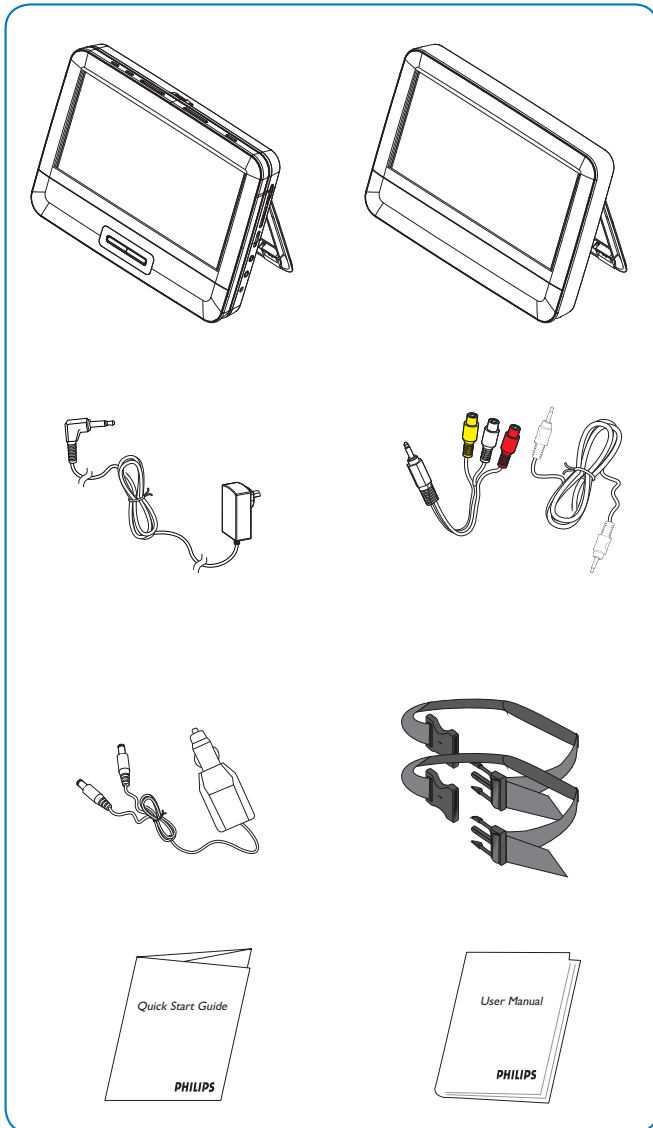

2

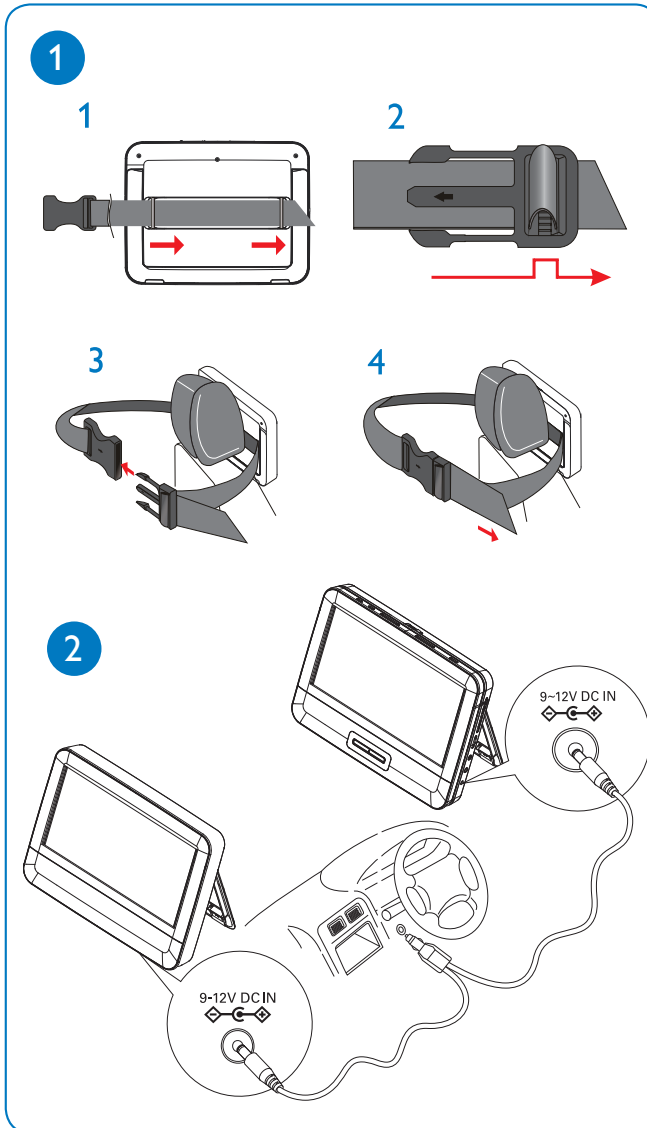

3

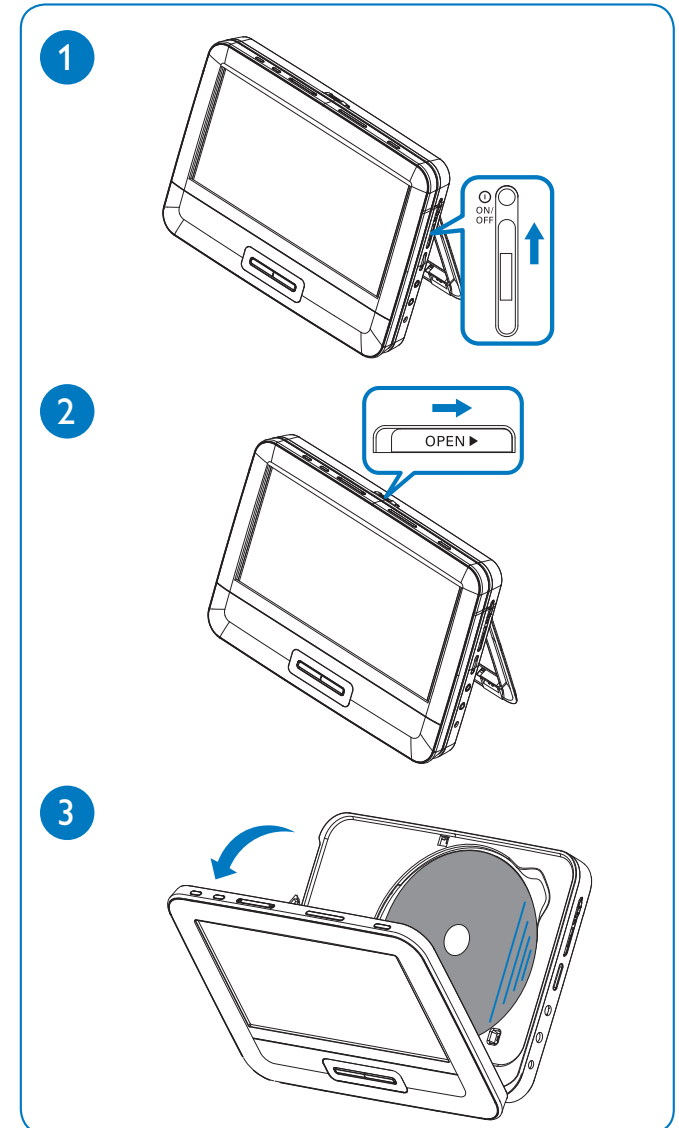

3 

4

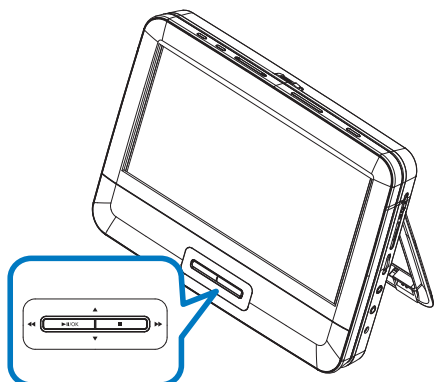

AV IN

AV OUT

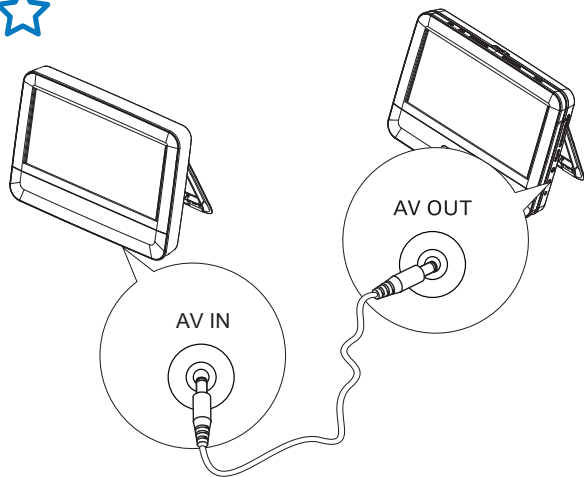

4 

SETUP

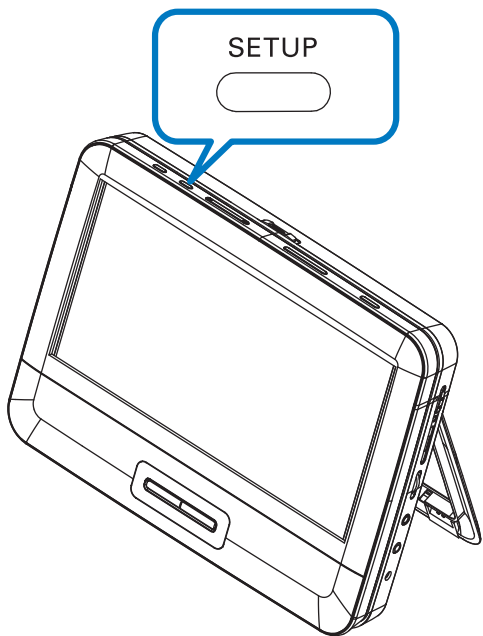

↓

General	Display	Password	Prefer	Exit
-- General Setup Page --				
OSD Language	Eng	English		
Screen Saver	On	Francais		
Resume	On	Español		
Angle Mark	Off			
Set OSD Language English				

↓

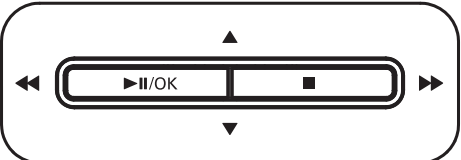

5 

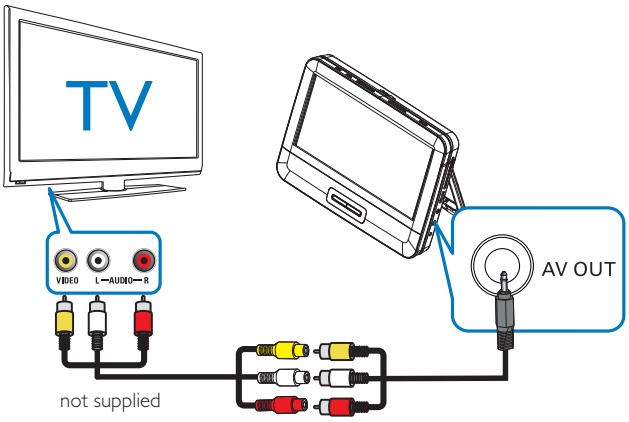

not supplied  
no suministrados  
non fournis

6 



<http://www.welcome.philips.com/>

