

Always there to help you

Register your product and get support at

www.philips.com/welcome

PD7042



User manual 3

Benutzerhandbuch 51

Mode d'emploi 99

Manual del usuario 147

Brugervejledning 27

Gebruiksaanwijzing 75

Manuale utente 123

Användarhandbok 171

PHILIPS

Contents

1 Important	5
Safety and notice	5
Safety	5
Compliance	6
Care of the environment	7
Copyright	8
Warranty	9

2 Your portable DVD player	10
What's in the box	10
Overview of the main unit	11

3 Get started	13
Prepare	13
Switch on/off	17
Select OSD language	18

4 Play music or movies	19
Play discs	19
Connect additional equipment	21

5 Adjust settings	23
Adjust settings	23

6	Product information	25
<hr/>		
7	Troubleshooting	26

1 Important

Safety and notice

Read and understand all instructions before you use this product. If damage is caused by failure to follow the instructions, the warranty does not apply.

Safety

Only use attachments/accessories specified by the manufacturer.

The product shall not be exposed to dripping or splashing.

Do not place any sources of danger on the product (e.g. liquid filled objects, lighted candles).

Batteries (battery pack or batteries installed) shall not be exposed to excessive heat such as sunshine, fire or the like.

Danger of explosion if battery is incorrectly replaced. Replace only with the same or equivalent type.

Modification of the product could result in hazardous radiation of EMC or other unsafe operation.



Warning

- Where the MAINS plug or an appliance coupler is used as the disconnect device, the disconnect device shall remain readily operable.



Warning

- Never remove the casing of this product.
- Never lubricate any part of this product.
- Never place this product on other electrical equipment.
- Keep this product away from direct sunlight, naked flames or heat.
- Never look into the laser beam inside this product.
- Ensure that you always have easy access to the power cord, plug or adaptor to disconnect the product from the power.

Hearing safety



A pleine puissance, l'écoute prolongée du baladeur peut endommager l'oreille de l'utilisateur.



Warning

- To prevent possible hearing damage, do not listen at high volume levels for long periods.

The maximum output voltage of the player is not greater than 150 mV.

Compliance



This product complies with the radio interference requirements of the European Community.

This apparatus includes this label:



Note

- The type plate is located on the bottom of the product.

Care of the environment

Environmental information

All unnecessary packaging has been omitted. We have tried to make the packaging easy to separate into three materials: cardboard (box), polystyrene foam (buffer) and polyethylene (bags, protective foam sheet.)

Your system consists of materials which can be recycled and reused if disassembled by a specialized company. Please observe the local regulations regarding the disposal of packaging materials, and old equipment.



Your product is designed and manufactured with high quality materials and components, which can be recycled and reused.



When this crossed-out wheeled bin symbol is attached to a product it means that the product is covered by the European Directive 2002/96/EC.

Please inform yourself about the local separate collection system for electrical and electronic products.

Please act according to your local rules and do not dispose of your old products with your normal household waste. Correct disposal of your old product helps to prevent potential negative consequences for the environment and human health.



Your product contains batteries covered by the European Directive 2006/66/EC, which cannot be disposed with normal household waste. Please inform yourself about the local rules on separate collection of batteries because correct disposal helps to prevent negative consequences for the environmental and human health. Always bring your product to a professional to remove the built-in battery.

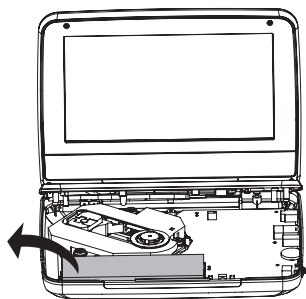

Copyright



Be responsible
Respect copyrights

This item incorporates copy protection technology that is protected by U.S. patents and other intellectual property rights of Rovi Corporation. Reverse engineering and disassembly are prohibited.

Specifications are subject to change without notice. Trademarks are the property of Koninklijke Philips Electronics N.V. or their respective owners. Philips reserves the right to change products at any time without being obliged to adjust earlier supplies accordingly.



Manufactured under license from Dolby Laboratories.
Dolby and the double-D symbol are trademarks of Dolby Laboratories.



ABOUT DIVX VIDEO: DivX® is a digital video format created by DivX.LLC, a subsidiary of Rovi Corporation. This is an official DivX Certified® device that plays DivX video. Visit divx.com for more information and software tools to convert your files into DivX videos.

ABOUT DIVX VIDEO-ON-DEMAND: This DivX Certified® device must be registered in order to play purchased DivX Video-on-Demand (VOD) movies. To obtain your registration code, locate the DivX VOD section in your device setup menu. Go to vod.divx.com for more information on how to complete your registration.

Warranty

- Never attempt to repair the product, this could lead to the risk of injury, damage to the product and will void your warranty.
- Use the product and accessories only as intended by the manufacturer. The caution sign printed on the back of the product indicates risk of electric shock.
- Never remove the cover of the product. Always contact Philips Customer Support for service or repairs.
- Any operation expressly prohibited in this manual, or any adjustments and assembly procedures not recommended or authorized in this manual shall void the warranty.

2 Your portable DVD player

You can play the following discs on the DVD player (including CD-R, CD-RW, DVD±R and DVD±RW):

- DVD-Video
- Video CD
- Audio CD
- MP3 CD
- DivX
- Discs with JPEG files

What's in the box

Check and identify the contents of your package:

- Main unit x 2
- AC power adaptor x 2, ASUC12E-090080 (Philips)
- Car adaptor x 1
- AV cable x 2
- Car mounting bracket x 2 (AY4246)
- Carry bag x 1
- Headphone x 2 (3822)
- User Manual x 1

Overview of the main unit

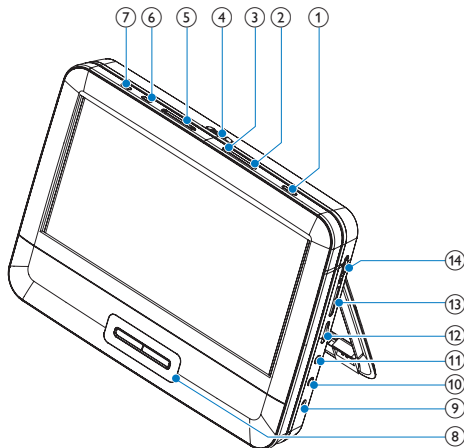

- ① ①
- Turns on/off DVD player.
- ② **OPTIONS**
- Accesses options relating to the current activity or selection.
- ③ **DISC MENU**
- For DVD, accesses or exits disc menu.
 - For VCD, turns on or off PBC (Playback Control) mode.
 - For VCD version 2.0 or SVCD with PBC turned on, returns to the menu.
- ④ **OPEN ►**
- Opens the disc compartment.
- ⑤ **◀▶**
- Skips to the previous or next title, chapter, or track.

- ⑥ **SETUP**
 - Accesses or exits the setup menu.
- ⑦ **AV MODE**
 - Switches between the PAL and NTSC mode.
- ⑧ **▲, ▼, ◀, ▶**
 - Navigates menus.**◀◀, ▶▶**
 - Searches backward/forward at different speeds.**▶||/OK**
 - Confirms an entry or selection.
 - Starts, pauses or resumes disc play.**■**
 - Stops disc play.
- ⑨ **DC IN**
 - Power supply socket.
- ⑩ **AV OUT**
 - Audio/video output jack.
- ⑪ **🎧**
 - Headphone jack.
- ⑫ **VOL +/-**
 - Increases or decreases volume.
- ⑬ **RESET**
 - When the player hangs up, press it with a ball-point pen or similar tool to reset the player.
- ⑭ **DVD/AV IN**
 - Switches between the DVD and audio/video (AV) input mode.

3 Get started



Caution

- Use the controls only as stated in this user manual.
- Always follow the instructions in this chapter in sequence.

If you contact Philips, you will be asked for the model and serial number of your apparatus. The model number and serial number are on the back of the apparatus. Write the numbers here:

Model No. _____

Serial No. _____

Prepare

Charge power

Charge through the AC adaptor

- 1 Press  to switch off the player.
- 2 Connect the supplied AC adaptor to the player and to the AC outlet.

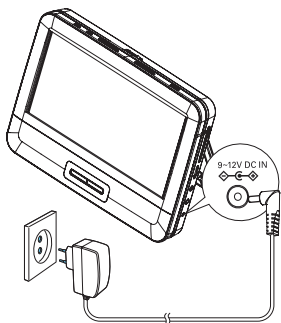



- ↳ The **CHR** indicator turns on (red).
- ↳ When the battery is fully charged, the **CHR** indicator turns off.

Note

- You can only charge the player when it is in power-off mode.
- To maximize battery life, recharge the battery immediately once the battery is fully discharged. If you do not use the player for a long time, recharge the battery once every two months.

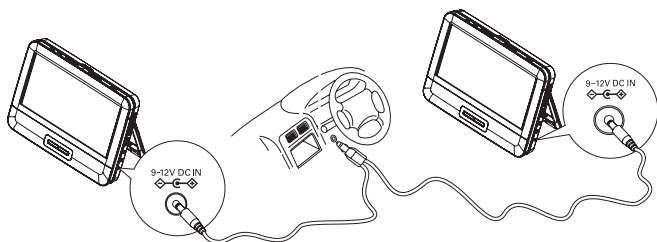
Connect power through the car adaptor



- 1 Press  to switch off the player.
- 2 Use the supplied car adaptor to connect the player to the cigarette lighter socket in your car.

Mount the player in your car (for in-car use)

Use the car mounting kit to mount the player onto the seat headrest in your car.

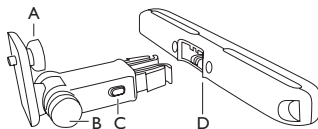

- A. Fastening screw node for DVD player
 B. Adjustment node for viewing angles

- C. Buckle release button
- D. Headrest mount bracket

**Warning**

- Remove the mounting kit and the DVD player from the seat when the DVD player is not in use.

To mount the DVD player onto the headrest

- 1** Fix the headrest mount bracket on to the front seat headrest.

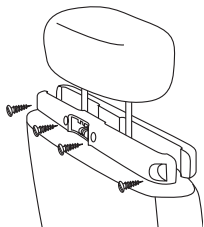

- ① Position the bracket on the bars of the headrest.
 - ② Fasten the screw to fix the bracket firmly on the bars.
- 2** Fix the DVD mount bracket to the portable DVD player:
 - ① Aim the fastening screw of the bracket to the screw nut on the back of the DVD player.
 - ② Screw tight the bracket onto the DVD player.

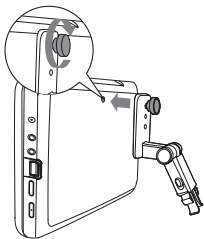

There are three holes on the bracket. Use any one as you like.

- 3** Install the DVD player to the headrest.

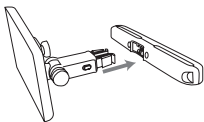

- Buckle DVD bracket into the headrest mount bracket.

- 4** Adjust the viewing angle.

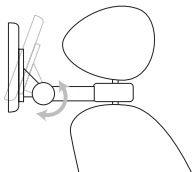

- ① Release the adjustment node.
- ② Adjust the viewing angle as desired.
- ③ Fasten the node.

To release the DVD player from the headrest

- Press the release button

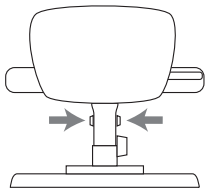

Use a player as dual screen

To have the two players play the same content, use one player as dual screen:

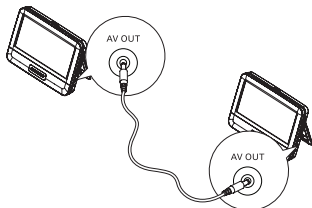

- 1 Through **AV OUT**, use the supplied AV cable to connect the two players.
- 2 To use a player as dual screen:
 - On the player, slide **DVD/AV IN** to **AV IN**.
 - ↳ You can watch the disc play on another player.

Switch on/off

- 1 Press **⏻** to switch on the player.
 - ↳ The power indicator turns on.
- 2 To switch off the player, press **⏻**.
 - ↳ The power indicator turns off.

Select OSD language

You can choose a different language for the on-screen display text.

- 1 Slide the **DVD/AV IN** switch to **DVD**.
- 2 Press **SETUP**.
↳ The setup menu is displayed.



- 3 Go to [-- General Setup Page --] > [OSD Language] (on-screen display language).
- 4 Press ▲ / ▼ to select a language.
- 5 Press ► || /OK to confirm.
- 6 Press **SETUP** to exit.

4 Play music or movies

Play discs

- 1 Slide the **DVD/AV IN** switch to **DVD**.
 - 2 Slide **OPEN ▶** on the main unit.
 - 3 Insert the disc with label side facing you.
 - 4 Push down to close the disc compartment.
 - ↳ Play starts automatically. If not, press **▶||/OK**.
 - If a menu is displayed, select an item, and then press **▶||/OK** to start play.
 - To pause, press **▶||/OK**. Press again to resume play.
 - To stop, press **■** twice.
 - To select the previous/next item, press **◀** or **▶**.
 - To start search within video/audio, press **◀◀** or **▶▶** once or more.
-

Play options

Select subtitle language

For DVDs that contain two or more subtitle languages,

- 1 Press **OPTIONS**.
 - ↳ The option menu is displayed.
- 2 Select **[Subtitle]**.
- 3 Press **◀◀/▶▶** to select a subtitle.
- 4 Press **▶||/OK** to confirm.

Select audio language

For DVDs that contain two or more subtitle languages,

- 1 Press **OPTIONS**.
 - ↳ The option menu is displayed.
- 2 Select **[Audio]**.
- 3 Press **◀◀/▶▶** to select a language.

4 Press **▶||**/OK to confirm.

Repeat

During play, you can select different repeat options.

1 Press **OPTIONS**.

↳ The option menu is displayed.

2 Select **[Repeat]**, then press navigation keys to select a repeat option.
For DVD

- **[Repeat Off]**: switch off the repeat mode
- **↻ [Chapter]**: repeat the current chapter
- **↻ [Title]**: repeat the current title or track
- **↻ [All]**: repeat all titles on the disc

For VCD/MP3/CD/DivX

- **[Repeat Off]**: switch off the repeat mode
- **↻ [Track]**: repeat the current track
- **↻ [All]**: repeat all the tracks

3 Select an option, then press **▶||**/OK to confirm.

4 Press **OPTIONS** to exit.



Tip

- For VCDs, if PBC is on, you cannot repeat items.

Display play time

During play, press **OPTIONS**.

↳ The option menu is displayed.

1 Select **[Time Disp.]**, then press **◀◀/▶▶** to select a display option.

↳ The display options are different depending on the disc type.

Option	Action
[Title Elapsed] / [Chapter Elapsed]	Displays DVD title or chapter elapsed play time.
[Title Remain] / [Chapter Remain]	Displays DVD title or chapter remaining play time.

[Total Elapsed] / [Single Elapsed]	Displays VCD/SVCD disc or track elapsed play time.
[Total Remain] / [Single Remain]	Displays VCD/SVCD disc or track remaining play time.

2 Select an option, then press ►||/OK.

Select audio mode

When you play VCDs, you can select an audio mode.

- 1 Press **OPTIONS**.
↳ The option menu is displayed.
- 2 Select **[Audio]**.
- 3 Press ◀◀/▶▶ to select audio channel: **[Stereo]**, **[Mono Left]** or **[Mono Right]**.

Rotate pictures

For JPEG CDs only. While the JPEG is displayed:

- Press ▲ to flip up/down.
- Press ▼ to flip left/right.

Connect additional equipment

You can connect the player to a TV or an amplifier to enjoy DVDs.

Connect to a TV



Caution

- Turn off your player before connecting to any additional equipment.

Match the color of the AV cables (the AV cable connected to TV is not supplied) with the jacks:

- the yellow cable is for the yellow video jack
- the red/white cable is for the red/white audio jacks.

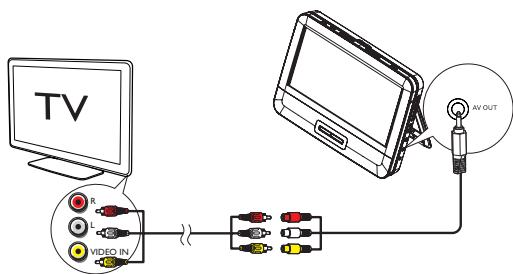

5 Adjust settings

Adjust settings

To maximize your play experience, use **SETUP** to fine tune your settings.

- 1 Press **SETUP**.
↳ The setup menu is displayed.
- 2 Use navigation keys to select an option and press **▶||/OK** to confirm.

[-- General Setup Page --]

[OSD Language]	Select an on-screen display language.
[Screen Saver]	Activate/deactivate the screen saver.
[Last Memory]	Select whether to start play from the point where the video was stopped last time.
[Angle Mark]	Select angle mark display options.

[-- Video Setup Page --]

[Brightness]	Adjust screen brightness.
[Contrast]	Adjust screen contrast.
[TV Display]	Select a display ratio.
[TV Type]	Select a TV standard.

[-- Battery Life Setup Page --]

[LCD Backlight]	Adjust the default brightness level of screen backlight.
-----------------	--

[-- Preference Page --]

[Audio]	Select a audio language.
[Subtitle]	Select a DVD subtitle language.
[Disc Menu]	Select a disc menu language.
[Parental]	Select a parental level.
[DivX Subtitle]	Select a DivX subtitle language.

[Password]	Change the password (3308 by default).
[DivX VOD]	Get DivX registration code.
[Default]	Restore original settings.

- 3 Press ◀ to go back to previous menu level.
- 4 Press **SETUP** to exit.

6 Product information



Note

- Product information is subject to change without prior notice.

Dimensions

- Main unit 195 x 152 x 29 mm

Weight

- Main unit 0.7 kg

AC power adaptor ASUL12E-090080 (Philips)

Power supply Input: 100-240V~ 50/60Hz 0.3A
Output: DC 9V \approx 0.8A
minimum

Power consumption 9.0 W

Operating temperature range 0-45°C

Laser wavelength 650 nm

Video output

Format PAL & NTSC

Output level 1V_p - p \pm 20%

Load impedance 75 Ω

Audio line out

Audio out (analog audio) Output level: 2V \pm 10%

Load impedance 10 K Ω

Audio distortion + noise \leq -80 (1KHz)

Frequency response 20Hz-20KHz \pm 1dB

Signal/noise ratio \geq 80 dB

Channel separation \geq 80 dB

Dynamic range \geq 80 dB

7 Troubleshooting

No power

- Ensure that both plugs of the mains cord are properly connected.
- Ensure that there is power at the car cigarette lighter or AC outlet.

No sound

- Adjust the volume.
- Ensure that the AV cable is connected correctly.

Distorted picture

- Clean the disc. With a clean, soft, lint-free cloth, wipe the disc outwards from the center.
- Make sure that the video output format of the disc is compatible with the TV.
- Change the video output format to match your TV or program.
- The LCD is manufactured using high precision technology. You may, however, see tiny black points and/or bright points (red, blue, green) that continuously appear on the LCD. This is a normal result of the manufacturing process and does not indicate a malfunction.

Cannot play disc

- Ensure the disc label is upwards.
- Clean the disc. With a clean, soft, lint-free cloth, wipe the disc outwards from the center.
- Check if the disc is defective by trying another disc.

Not work properly or freeze up

- Press **RESET** with a ball-point pen or similar tool to switch off the player; and press **⏪** to restart.

The player feels warm

- When the player is in use for a long period of time, its surface will be heated. This is normal.



Specifications are subject to change without notice
© 2012 Koninklijke Philips Electronics N.V.
All rights reserved.

PD7042_12_UM_V2.0

