

Always there to help you

Register your product and get support at
www.philips.com/welcome

OTT2000



User manual

PHILIPS

Contents

1	Safety	2
	Safety	2

2	Your classic micro sound system	4
	Introduction	4
	What's in the box	4
	Overview of the product	5

3	Get started	8
	Connect power	8
	Prepare remote control	8
	Turn on	8
	Set the clock	9

4	Play	10
	Play a disc	10
	Play vinyl record	11
	Play from USB	12
	Play from a Bluetooth device	12
	USB record	12

5	Listen to FM radio stations	14
	Search for a radio station automatically	14
	Program radio stations automatically	14
	Program radio stations manually	14
	Select stereo/mono broadcast	14

6	Listen to an external device	15
----------	-------------------------------------	-----------

7	Other features	16
	Set the sleep timer	16
	Set the alarm timer	16
	Adjust the volume	16

8	Product information	17
	Specifications	17
	USB playability information	18
	Supported MP3 disc formats	18

9	Troubleshooting	19
	General	19
	About Bluetooth connection	19

10	Notice	20
	Compliance	20
	Care for your product	20
	Care of the environment	20
	Trademark notice	21
	Copyright	21

1 Safety

Read and understand all instructions before you use this product. If damage is caused by failure to follow the instructions, the warranty does not apply.

Safety



Warning

- Never remove the casing of this apparatus.
- Never lubricate any part of this apparatus.
- Never look into the laser beam inside this apparatus.
- Never place this apparatus on other electrical equipment.
- Keep this apparatus away from direct sunlight, naked flames or heat.
- Ensure that you always have easy access to the power cord, plug or adaptor to disconnect the apparatus from the power.

- The device shall not be exposed to dripping or splashing.
- Do not place any source of danger on the device (e.g. liquid filled objects, lit candles).
- Where the MAINS plug or an appliance coupler is used as the disconnect device, the disconnect device shall remain readily operable.
- Make sure that there is enough free space around the product for ventilation.
- Only use attachments/accessories specified by the manufacturer.

Risk of electric shock or fire!

- Never expose the product and accessories to rain or water. Never place liquid containers, such as vases, near the product. If liquids are split on or into the product, disconnect it from the power outlet immediately. Contact Consumer Care to have the product checked before use.
- Never place the product and accessories near naked flames or other heat sources, including direct sunlight.

- Never insert objects into the ventilation slots or other openings on the product.
- Where the mains plug or an appliance coupler is used as the disconnect device, the disconnect device shall remain readily operable.
- Disconnect the product from the power outlet before lightning storms.
- When you disconnect the power cord, always pull the plug, never the cable.
- Never remove the casing of this product.

Risk of short circuit or fire!

- Before you connect the product to the power outlet, make sure that the power voltage matches the value printed on the back of the product. Never connect the product to the power outlet if the voltage is different.
- Never expose the product to rain, water, sunshine, or excessive heat.
- Avoid force coming onto power plugs. Loose power plugs can cause arcing or fire.

Risk of injury or damage to the product!

- This product shall not be exposed to dripping or splashing!
- Do not place any sources of danger on this product (e.g. liquid filled objects, lighted candles).
- Never place the product or any objects on power cords or on other electrical equipment.
- If the product is transported in temperatures below 5°C, unpack the product and wait until its temperature matches room temperature before connecting it to the power outlet.
- Only use attachments/accessories specified by the manufacturer.

Risk of overheating!

- Never install this product in a confined space. Always leave a space of at least four inches around the product for ventilation.
- Make sure that curtains or other objects never cover the ventilation slots on the product.

Risk of swallowing coin battery!

- The device may contain a coin/button type battery, which can potentially be swallowed. Keep the battery out of reach of children at all times! If swallowed, the battery can cause serious injury or death. Severe internal burns can occur within two hours of ingestion.
- If you suspect that a battery has been swallowed or placed inside any part of the body, seek immediate medical attention.
- When you change the batteries, always keep all new and used batteries out of reach of children. Make sure that the battery compartment is completely secure after you replace the battery.
- If the battery compartment cannot be completely secured, discontinue use of the product. Keep out of reach of children and contact the manufacturer.



Note

- The type plate is located on the back of the product.

2 Your classic micro sound system

Congratulations on your purchase, and welcome to Philips! To fully benefit from the support that Philips offers, register your product at www.philips.com/welcome.

Introduction

With this product, you can:

- listen to vinyl records,
- listen to FM radio stations,
- listen to audio CDs,
- listen to audio from an external device through the **AUDIO-IN** socket,
- listen to audio from an external device via Bluetooth connection.
- listen to audio from a USB storage device.

What's in the box

Check and identify the contents of the package:

- ① Main unit
- ② Short User manual
- ③ Safety & Notice sheet
- ④ AC power cord
- ⑤ Remote control

Overview of the product

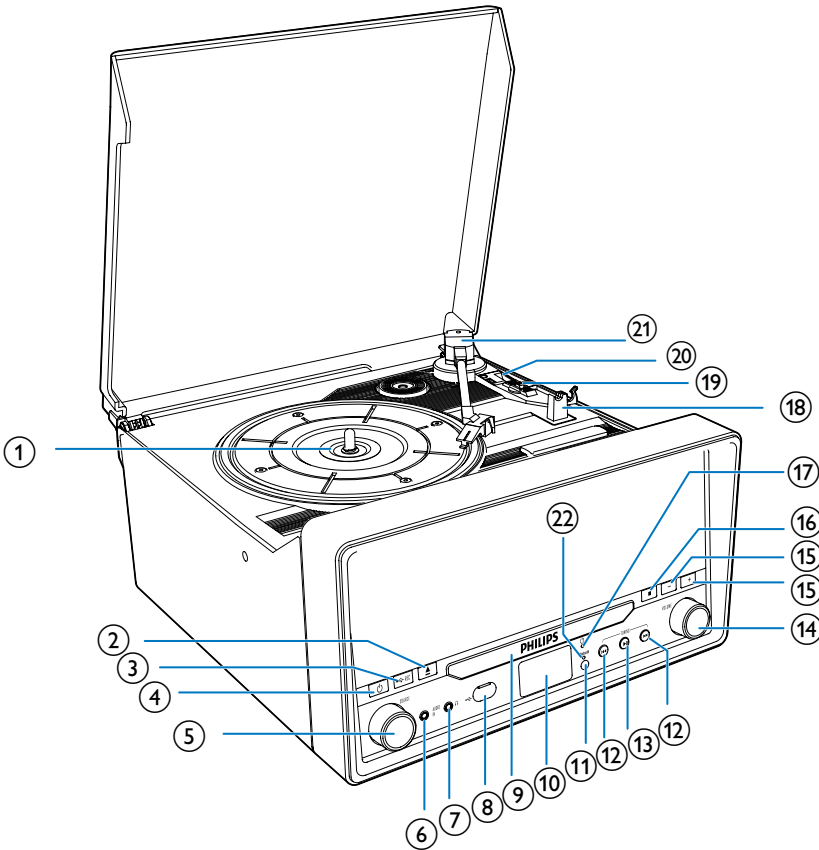

Overview of the device



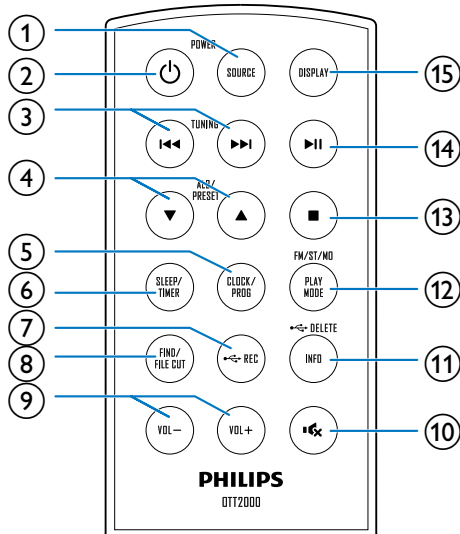

- ① **Vinyl record platter**
- ② ▲
 - Open/close the disc compartment.
- ③ **REC**
 - Record the track from disc/FM/Phono/AUX/Bluetooth to a USB device.
- ④ **⏻**
 - Turn on the device, or switch to Standby mode.
- ⑤ **SOURCE knob**
 - Select a source: CD, USB, FM, Phono/Aux, or Bluetooth.
- ⑥ **AUDIO IN**
 - Connect an external audio device.
- ⑦ **🎧**
 - Headphone socket.
- ⑧ **🔌**
 - USB socket.
- ⑨ **Disc compartment**

- ⑩ **Display panel**
 - Show current status.
- ⑪ **IR sensor**
 - Detect signals from the remote control (always point the remote control towards the IR sensor).
- ⑫ **⏮ / ⏭**
 - Skip to the previous/next track.
 - Tune to a radio station.
 - Press and hold the key to search within a track in disc/USB source.
 - Adjust time.
- ⑬ **▶**
 - Start or pause playback.
- ⑭ **VOLUME**
 - Rotate the knob to adjust volume.
- ⑮ **+/-**
 - Skip to the previous/next album.
 - Select a preset radio station.
- ⑯ **■**
 - Stop play.
 - Erase a program.
- ⑰ **power indicator**
 - Lights when the unit is in standby mode.
- ⑱ **Arm rest**
- ⑲ **Auto stop selector**
- ⑳ **Speed selector**
- ㉑ **Tone arm**
- ㉒ **Bluetooth indicator**
 - Flashes when the unit is in pairing mode or connecting mode.
 - Lights when the unit is connected with Bluetooth compatible device.

Overview of remote control



- ① **SOURCE**
 - Select a source: CD, USB, FM, Phono/Aux, or Bluetooth.
- ② **⏻**
 - Turn on the device, or switch to Standby mode.
- ③ **⏮ / ⏭**
 - Skip to the previous/next track.
 - Tune to a radio station.
 - Press and hold the key to search within a track in disc/USB source.
 - Adjust time.
- ④ **▲ / ▼**
 - Skip to the previous/next album.
 - Select a preset radio station.
 - Adjust time.
- ⑤ **CLOCK/PROG**
 - Set clock in standby mode.
 - Program tracks in disc/USB source.
 - Program radio stations.
- ⑥ **SLEEP/TIMER**
 - Set the sleep timer.
 - Set the alarm timer.

- ⑦  **REC**
- Record the track from disc/FM/Photo/AUX/Bluetooth to a USB device.
- ⑧ **FIND/FILE CUT**
- Search tracks by title or by folder name in disc/USB source.
 - Press to cut the audio file when recording audio files from Phono/AUX/Bluetooth source to a USB storage device.
- ⑨ **VOL +/-**
- Increase or decrease volume.
- ⑩  **嗽**
- Mute or restore volume.
- ⑪ **INFO/DELETE**
- In disc/USB source, press to display the playback information of .mp3 files.
 - Delete files from the USB storage device.
- ⑫ **PLAY MODE/FM/ST/MO**
- In disc/USB source, select repeat play mode.
 - In disc/USB source, select random play mode.
 - In FM source, select stereo playback or mono playback.
- ⑬  **■**
- Stop playback.
- ⑭  **▶||**
- Start or pause playback.
- ⑮ **DISPLAY**
- Display the time in any source mode.

3 Get started

Always follow the instructions in this chapter in sequence.

Connect power

Connect the AC power cord to the **AC MAIN~** socket and then to the wall outlet.

Prepare remote control

Caution

- Risk of explosion! Keep batteries away from heat, sunshine or fire. Never discard batteries in fire.
- Danger of explosion if battery is incorrectly replaced. Replace only with the same or equivalent type.

For first-time use:

1 Remove the protective tab to activate the remote control battery.

To replace the remote control battery:

- 1** Open the battery compartment.
- 2** Insert one CR2032 battery with correct polarity (+/-) as indicated.
- 3** Close the battery compartment.

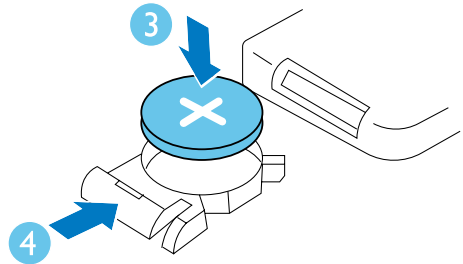
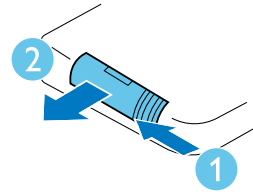

Note

- Before pressing any function button on the remote control, first select the source with the remote control and not the main unit.
- If the the remote control will not be used for an extended period of time, remove the battery.

Turn on

Press .

- ↳ The product switches to the last selected source.
- To switch the product to standby mode, press  again.

Set the clock

- 1 In standby mode, press **CLOCK/PROG**.
- 2 Press **◀◀ / ▶▶** to select a time format, and then press **CLOCK/PROG** to confirm.
↳ Hour digits blink.
- 3 Press **◀◀ / ▶▶** to set the hour, and then press **CLOCK/PROG** to confirm.
↳ Minute digits blink.
- 4 Press **◀◀ / ▶▶** to the minute and then press **CLOCK/PROG** to confirm.

4 Play

Play a disc

- 1 Press **SOURCE** repeatedly to select CD source.
- 2 Press **▲** to open the disc compartment.
- 3 Insert a disc with the printed side facing up, and then close the disc compartment.
- 4 Play starts automatically. If not, press **▶||**.

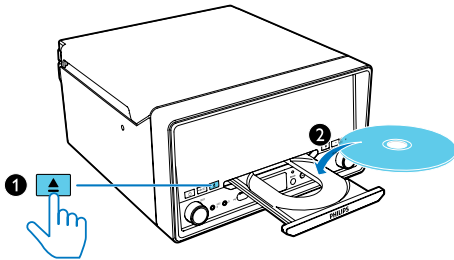

Pause/resume play

- During play, press **▶||** to pause/resume play.

Skip to a track

For CD:

- Press **◀◀ / ▶▶** to select another track.

For MP3 disc and USB:

- 1 Press **PRESET/ALBUM ▲ / ▼** to select an album or a folder.
- 2 Press **◀◀ / ▶▶** to select a track or a file.

Search within a track

- 1 During play, press and hold **◀◀ / ▶▶**.
- 2 Release to resume normal play.

Program tracks

Note

- You can program tracks only when the play stops.
- You can program a maximum of 20 tracks.

- 1 In playback stop mode, press **CLOCK/PROG** to activate the program mode.
↳ **[MEMORY]** (memory is displayed on the screen).
- 2 For MP3 tracks, press **▲ / ▼** to select an album.
- 3 Press **◀◀ / ▶▶** to select a track, then press **CLOCK/PROG** to confirm.
- 4 Repeat steps 2 to 3 to program more tracks.
- 5 Press **▶||** to play the programmed tracks.
 - To erase the program, in the stop position, press **■**.
 - The program mode stops automatically if no button is pressed for about 10 seconds.

Display play information

During playback, press and hold **INFO**.

- For CD:
 - Lap time of current track
 - Lap time remaining of current track
 - Total lap time of all tracks
 - Total lap time remaining of all tracks
- For MP3 disc and USB: ID3 information, such as **[TITLE]** (title), **[ARTIST]** (artist), **[ALBUM]** (album).

Search tracks

You can search a track by title or folder name within a disc/USB.

Note

- For MP3 files, the bit rates from 32 kbps to 320 kbps are supported.



For CD/MP3: Search by title

- 1 In playback stop mode, press **FIND/FILE CUT** once.
↳ The titles of all tracks are displayed in alphabetical order.
- 2 Press **◀◀ / ▶▶** to search for the desired track title in alphabetical order.
- 3 Press **▶||** start playback of the selected track.

For MP3: Search by folder

- 1 In playback stop mode, press **FIND/FILE CUT** twice.
↳ The folders are displayed in alphabetical order.
- 2 Press **◀◀ / ▶▶** to select a folder.
- 3 Press **▶||** start play all the tracks in the folder.

Select repeat/shuffle play options

- 1 During play, press **PLAY MODE/FM/ST/MO** to select a repeat option or the shuffle play mode.
 -  : Repeat the current track
 -  **FOLDER** : Repeat the current folder (for MP3 disc)
 -  ALL : Repeat all
 - **RAN.** : Random play
- 2 To resume normal play, press **PLAY MODE/FM/ST/MO** repeatedly until no option is displayed.

Play vinyl record

Caution

- Remove the stylus protector before use.
- Place one vinyl record on the platter at a time.
- Keep 15 cm at least between the device and other objects.

- 1 Press **SOURCE** repeatedly to select **PHONO/AUX** source.

- 2 Select the correct speed with the speed selector.
 - You can select speed 33 or speed 45 according to different vinyl type.
- 3 Place the vinyl record on the turntable platter.
- 4 Lift the tone arm carefully and move it towards the record.
↳ The turntable platter starts rotating automatically.
- 5 Gently lower the tone arm onto the edge of the record to begin playback from the beginning.
↳ Playback starts.
- 6 Adjust the volume to the desired level.
 - If **AUTO STOP** is set to **ON**, the platter stops rotating automatically after playback finishes.
- 7 Put the tone arm securely back on the arm rest.

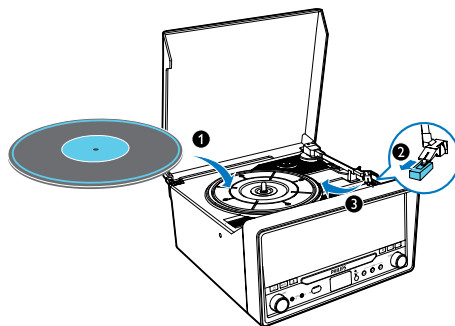

Note

- The micro system automatically switches to AUX source when there is an external device is connected through the **AUDIO IN** socket.

Play from USB

Note

- Make sure that the USB storage device contains playable audio content.
- Only MP3 files with bit rates from 32 kbps to 320 kbps are supported.
- The USB socket does not support connections with USB extension cables and is not designed for communicate directly with a computer.

- 1 Push down the USB protective cover and then insert a USB storage device into the  socket.

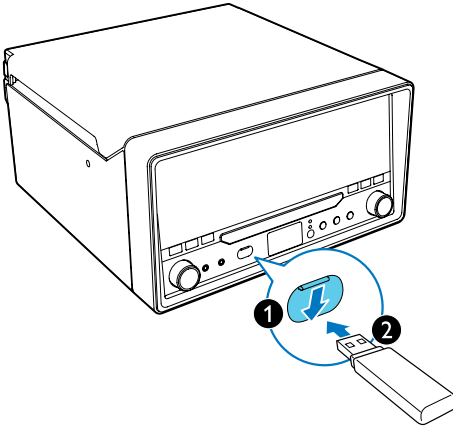

- 2 Press **SOURCE** repeatedly to select USB source.
↳ Play starts automatically. If not, press **▶||**
 - To select a folder, press **▲ / ▼**.
 - To select an audio file, press **◀◀ / ▶▶**.

Play from a Bluetooth device

You can listen to a Bluetooth device through the micro system.

Note

- Before you connect a Bluetooth device to the unit, familiarize yourself with the Bluetooth capabilities of the device.
- Keep the unit away from other electronic devices that may cause interference.
- The effective operation range between the unit and the paired device is approximately 10 meters (30 feet).
- Any obstacle between the unit and the device can reduce the operational range.

- 1 Press **SOURCE** repeatedly to select BT source.
↳ The Bluetooth indicator flashes blue.
- 2 Activate the Bluetooth function on your Bluetooth device (see the device user manual).
- 3 Select "PHILIPS OTT2000" on your device for pairing.
- 4 After successful connection, the Bluetooth indicator turns to solid blue.
- 5 Start music play on your Bluetooth device.

Tip



- If the micro system switches from a Bluetooth source to another source, the connected Bluetooth device disconnects automatically.
- The system can memorize up to 4 previously connected Bluetooth devices.

USB record

Audio CD tracks, MP3 discs, audio from vinyl record and Bluetooth, radio, and audio from external devices can be recorded as .mp3 format files to a USB storage device. The first time you record to the USB storage device, a folder named 'PHILIPS OTT2000' is automatically created in the USB storage device. Each time you record, the recorded files are stored to this folder:

Record to USB

Plug the USB storage device into the  socket of this device.

- 1 Prepare the source to record from.
 - Disc - Select the disc source and load a disc. You can select a track from which a recording starts.
 - Radio - Tune to a radio station.
 - AUX IN - Select the Phono /Aux source, then connect and start to play an external device.
 - Phono - Select the Phono /Aux source, then play the vinyl record.
 - Bluetooth - Select the Bluetooth source and play the tracks.
- 2 Press  **REC** to start recording.
 - For CD discs, press  **REC** repeatedly to select:
 - (A) **[REC_ONE]** (record one): the first/ current track is recorded.
 - (B) **[REC_ALL]** (record all): all tracks/the remaining tracks are recorded.
 - ↳ Disc play starts automatically from the beginning of the disc/the selected track, and the recording starts.
 - To stop recording, press .





Note

- If the USB storage device does not have enough memory to store the audio files, a message about a full memory is displayed.
- For CD disc, recording process is completed only when the entire track is recorded.
- For MP3 discs, the system copies files to the USB storage device if  **REC** is pressed.

Cut a file

When you record audio files from Bluetooth/ AUX/PHONO/FM to a USB storage device, you can cut a file by pressing **FIND/FILE CUT** during recording. A new audio file is generated and recording continues.

Delete file from USB

- 1 In playback stop mode, press **SOURCE** repeatedly to select USB source.
- 2 Press **INFO/**  **DELETE**.
↳ **DEL -- 001** is displayed in the screen.
- 3 Press **◀◀/▶▶** to select the file to be deleted.
- 4 Press **DELETE** to confirm.
 - To exit file deletion mode, press .

5 Listen to FM radio stations

- 1 Turn the **SOURCE** knob to select FM source.
- 2 Search for radio stations automatically or manually.

Note

- For optimal reception, fully extend the antenna and adjust its position.
- You can store a maximum of 20 FM radio stations.

Search for a radio station automatically

- 1 Press and hold **◀▶** for more than 2 seconds.
 - ↳ The radio automatically tunes to a station with strong reception.
- 2 Repeat step 1 to tune to more stations.
 - ↳ When a radio station with a strong signal is detected, the search stops and the radio station is broadcast.

Program radio stations automatically

- 1 Press **CLOCK/PROG** for more than 2 seconds to activate automatic program mode.
 - ↳ All available stations are programmed in the order of waveband reception strength.
 - ↳ The first programmed radio station is broadcast automatically.
- 2 Press **▲/▼** to select preset radio stations.

Program radio stations manually

- 1 Press **◀▶** to tune to a radio station.
- 2 Press **CLOCK/PROG** to activate the programming.
- 3 Press **▲/▼** to allocate a number to this radio station.
- 4 Press **CLOCK/PROG** to confirm.
 - ↳ The radio station is stored with the selected sequence number.
- 5 Repeat steps 1-4 to program more radio stations.

Note

- If a radio station is stored over the sequence number of a previously saved station, the earlier station will be overwritten.

Select stereo/mono broadcast

To improve the reception of stations with weak signals, monaural sound should be selected.

- In tuner source, press **FM/ST/MO** to select a setting:
 - **[STEREO]**: stereo broadcast.
 - **[MONO]**: monaural broadcast.

6 Listen to an external device

You can also listen to an external audio device, for example, MP3 player, through this product.

- 1 Turn the **SOURCE** knob to select **PHONO/AUX** mode.
- 2 Connect the audio in cable to
 - the **AUDIO IN** socket on the front panel of this product, and
 - the headphone jack on the external device.
- 3 Play the external device (refer to its user manual).

7 Other features

Set the sleep timer

This micro sound system can automatically switch to standby after a set period of time.

- When the micro system is turned on, press **SLEEP/TIMER** repeatedly to select a set period of time (in minutes).
 - [SLEEP -- 90]
 - [SLEEP -- 75]
 - [SLEEP -- 60]
 - [SLEEP -- 45]
 - [SLEEP -- 30]
 - [SLEEP -- 15]
 - [OFF]
- ↳ When sleep timer is activated, [SLEEP] is displayed.

To deactivate sleep timer

- Press **SLEEP/TIMER** repeatedly until [SLEEP OFF] (sleep off) is displayed.
 - ↳ When sleep timer is deactivated, [SLEEP] disappears.

Set the alarm timer

This micro system can be used as an alarm clock. The disc, USB, or tuner is activated to play at a preset time.

- 1 Press \odot to switch the unit to standby mode.
- 2 Make sure that you have set the clock correctly.
- 3 Press and hold **SLEEP/TIMER**.
 - ↳ A prompt to select the source is displayed.
- 4 Press **SOURCE** repeatedly to select a source: CD, USB, or FM.

- 5 Press **SLEEP/TIMER** to confirm.
 - ↳ The hour digits begin to blink.
- 6 Press **◀◀ / ▶▶** to set the hour.
- 7 Press **SLEEP/TIMER** to confirm.
 - ↳ The minute digits begin to blink.
- 8 Press **◀◀ / ▶▶** to set the minute.
- 9 Press **SLEEP/TIMER** to confirm.
 - ↳ The timer is set and activated.

Activate and deactivate the alarm timer

- 1 Press \odot to switch the micro system to standby mode.
- 2 Press **SLEEP/TIMER** repeatedly to activate or deactivate the timer.
 - ↳ If the timer is activated, the display shows ⌚ .
 - ↳ If the timer is deactivated, ⌚ is not shown on the display.

Note

- If DISC/USB source is selected and the track cannot be played, tuner is automatically activated.
- The micro sound system automatically switches to standby mode if no operation is performed within 30 minutes after the alarm source is activated.

Adjust the volume

Turn the **VOLUME** knob to increase/decrease volume.

8 Product information

Note

- Product information is subject to change without prior notice.

Specifications

General information

AC Power Rating	220 - 240 V~, 50 Hz
Operation Power Consumption	16 W
Standby power consumption	< 1 W
Dimensions - Main Unit (W x H x D)	335 x 311 x 169 mm
Weight (Main Unit)	2.5 kg

Tuner

Tuning Range	FM: 87.50 - 108.00 MHz;
Tuning grid	50 kHz
Total Harmonic Distortion	< 2%
Signal to Noise Ratio	> 50 dB
Number of preset radio stations	20

Vinyl

Supported vinyl size	7 inch 12inch
Speed	33/45

Amplifier

Rated Output Power	1.5 W x 2 RMS
Frequency Response	60 Hz - 16 kHz, ±3 dB
Signal to Noise Ratio	> 65 dB
Aux Input	0.5 V RMS 20 kohm

Speakers

Speaker Impedance	4 ohm
Speaker Driver	2 X 3" full range
Sensitivity	84 dB/m/W

Bluetooth

Communication system	Bluetooth Standard version 2.1
Output	Bluetooth Standard Power Class 2
Maximum communication range	Line of sight approx. 10m (30 feet)
Frequency band	2.4 GHz band (2.4000 GHz - 2.4835 GHz)
Compatible Bluetooth profiles	Advanced Audio Distribution Profile (A2DP)
Supported codecs	SBC (Sub Band Codec)
- Receive	Not supported
- Transmit	

USB playability information

Compatible USB devices:

- USB flash memory (USB 1.1 and USB 2.0)
- USB flash players (USB 1.1 and USB 2.0)
- memory cards (requires an additional card reader to work with this unit)

Supported formats:

- USB or memory file format FAT12, FAT16, FAT32 (sector size: 512 bytes)
- MP3 bit rate (data rate): 32-320 Kbps and variable bit rate
- Directory nesting up to a maximum of 8 levels
- Number of albums/ folders: maximum 99
- Number of tracks/titles: maximum 999
- ID3 tag v2.0 to v2.3
- File name in Unicode UTF8 (maximum length: 16 bytes)

Supported MP3 disc formats

- ISO9660, Joliet
- Maximum title number: 999 (depending on file name length)
- Maximum album number: 99
- Supported sampling frequencies: 32 kHz, 44.1 kHz, 48 kHz
- Supported Bit-rates: 32~320 (kbps), variable bit rates

9 Troubleshooting



Warning

- Never remove the casing of this product.

To keep the warranty valid, never try to repair the product yourself.

If you encounter problems when using this product, check the following points before requesting service. If the problem remains unsolved, go to the Philips Web page (www.philips.com/support). When you contact Philips, make sure that the product is nearby and the model number and serial number are available.

General

No power

- Make sure that the AC power cord is properly connected.
- Make sure that there is power at the AC power outlet.

No sound

- Adjust the volume.
- When listening to an external device, make sure that the external device is not muted.

No response from the product

- Make sure that the power is available.
- Turn off the product, and then turn it on again.

Poor radio reception

- Due to the interference from other electrics or building obstacles, the signals become weak. Move the product to a place free of interference.
- Make sure that the antenna is fully extended. Adjust the position of the antenna.

Clock/alarm setting is erased.

- Power has been interrupted, or the AC power adaptor has been disconnected.
- Set the clock/alarm again.

About Bluetooth connection

Music playback is unavailable on this product even after successful Bluetooth connection.

- The device cannot be used with this product to play music.

The audio quality is poor after connection with a Bluetooth-enabled device.

- The Bluetooth reception is poor. Move the device closer to this product or remove any obstacle between.

Cannot connect with this product.

- The device does not support the profiles required for this product.
- The Bluetooth function of the device is not enabled. Refer to the user manual of the device to find out how to enable the function.
- This product is not in the pairing mode.
- This product is already connected with another Bluetooth-enabled device. Disconnect that device and then try again.
- Press \odot to restart the product or switch the product to Bluetooth source again for reconnection.

The paired mobile device connects and disconnects constantly.

- The Bluetooth reception is poor. Move the device closer to this product or remove any obstacle between.
- Some mobile phones may connect and disconnect constantly when you make or end calls. This does not indicate any malfunction of this product.
- For some devices, the Bluetooth connection may be deactivated automatically as a power-saving feature. This does not indicate any malfunction of this product.

10 Notice

Any changes or modifications made to this device that are not expressly approved by WOOX Innovations may void the user's authority to operate the equipment.

Compliance

CE 0890

This product complies with the radio interference requirements of the European Community. Hereby, WOOX Innovations declares that this product is in compliance with the essential requirements and other relevant provisions of Directive 1999/5/EC. You can find the Declaration of Conformity on www.philips.com/support.



This is CLASS II apparatus with double insulation, and no protective earth provided.

Care for your product

- Do not insert any objects other than discs into the disc compartment.
- Do not insert warped or cracked discs into the disc compartment.
- Remove the discs from the disc compartment if you are not using the product for an extended period of time.
- Only use microfiber cloth to clean the product.

Care of the environment



Your product is designed and manufactured with high quality materials and components, which can be recycled and reused.



When this crossed-out wheeled bin symbol is attached to a product it means that the product is covered by the European Directive 2002/96/EC. Please inform yourself about the local separate collection system for electrical and electronic products.

Please act according to your local rules and do not dispose of your old products with your normal household waste. Correct disposal of your old product helps to prevent potential negative consequences for the environment and human health.



Your product contains batteries covered by the European Directive 2006/66/EC, which cannot be disposed with normal household waste. Please inform yourself about the local rules on separate collection of batteries because correct disposal helps to prevent negative consequences for the environmental and human health.

Environmental information

All unnecessary packaging has been omitted. We have tried to make the packaging easy to separate into three materials: cardboard (box), polystyrene foam (buffer) and polyethylene (bags, protective foam sheet.)

Your system consists of materials which can be recycled and reused if disassembled by a specialized company. Please observe the local regulations regarding the disposal of packaging materials, exhausted batteries and old equipment.

Trademark notice

Bluetooth

The Bluetooth® word mark and logos are registered trademarks owned by Bluetooth SIG, Inc. and any use of such marks by WOOX Innovations is under license.

Copyright

2013 © WOOX Innovations Limited. All rights reserved.

Specifications are subject to change without notice. WOOX reserves the right to change products at any time without being obliged to adjust earlier supplies accordingly.



Specifications are subject to change without notice
2013 © WOOX Innovations Limited. All rights reserved.
This product was brought to the market by WOOX
Innovations Limited or one of its affiliates, further referred
to in this document as WOOX Innovations, and is the
manufacturer of the product. WOOX Innovations is the
warrantor in relation to the product with which this booklet
was packaged. Philips and the Philips Shield Emblem are
registered trademarks of Koninklijke Philips N.V.

