

# Always there to help you

Register your product and get support at  
[www.philips.com/welcome](http://www.philips.com/welcome)

ORT7500



## User manual

# PHILIPS



# Contents

---

<b>1 Safety</b>	2
Important notes for users in the U.K.	2

---

<b>2 Your DAB+ Radio</b>	4
Introduction	4
What's in the box	4
Overview of the product	5

---

<b>3 Get started</b>	6
Connect power	6
Turn on	6
Set the clock	6

---

<b>4 Listen to FM radio stations</b>	7
Search for a radio station automatically	7
Store radio stations automatically	7
Program radio stations manually	8
Display RDS information	8
Adjust FM settings	9

---

<b>5 Listen to DAB radio stations</b>	10
For the first time use	10
Program radio stations	10
Display DAB information	10
Use DAB menus	11

---

<b>6 Use system menus</b>	12
Check the current software version	12
Reset the product	12
Upgrade the software	12

---

<b>7 Listen to an external device</b>	13
---------------------------------------	----

---

<b>8 Play audio via Bluetooth</b>	14
-----------------------------------	----

---

<b>9 Charge your devices</b>	15
------------------------------	----

---

<b>10 Adjust the volume</b>	15
-----------------------------	----

---

<b>11 Product information</b>	16
General information	16
Tuner	16
Amplifier	16
Speakers	16
Bluetooth	16

---

<b>12 Troubleshooting</b>	17
General	17
About Bluetooth connection	17

---

<b>13 Notice</b>	18
Compliance	18
Care of the environment	18
Trademark notice	18
Copyright	18

# 1 Safety

Read and understand all instructions before you use this product. If damage is caused by failure to follow the instructions, the warranty does not apply.

## Risk of electric shock or fire!

- Never expose the product and accessories to rain or water. Never place liquid containers, such as vases, near the product. If liquids are spilt on or into the product, disconnect it from the power outlet immediately. Contact Philips Consumer Care to have the product checked before use.
- Never place the product and accessories near naked flames or other heat sources, including direct sunlight.
- Never insert objects into the ventilation slots or other openings on the product.
- Where the mains plug or an appliance coupler is used as the disconnect device, the disconnect device shall remain readily operable.
- Disconnect the product from the power outlet before lightning storms.
- When you disconnect the power cord, always pull the plug, never the cable.
- Never remove the casing of this product.

## Risk of short circuit or fire!

- Before you connect the product to the power outlet, make sure that the power voltage matches the value printed on the back of the product. Never connect the product to the power outlet if the voltage is different.
- Never expose the product to rain, water, sunshine, or excessive heat.
- Avoid force coming onto power plugs. Loose power plugs can cause arcing or fire.

## Risk of injury or damage to the product!

- This product shall not be exposed to dripping or splashing!
- Do not place any sources of danger on this product (e.g. liquid filled objects, lighted candles).
- Never place the product or any objects on power cords or on other electrical equipment.
- If the product is transported in temperatures below 5°C, unpack the product and wait until its temperature matches room temperature before connecting it to the power outlet.
- Only use attachments/accessories specified by the manufacturer.

## Risk of overheating!

- Never install this product in a confined space. Always leave a space of at least four inches around the product for ventilation.
- Make sure that curtains or other objects never cover the ventilation slots on the product.

### Note

- The type plate is located on the back of the product.

---

## Important notes for users in the U.K.

### Mains fuse

This information applies only to products with a UK mains plug.

This product is fitted with an approved molded plug. If you replace the fuse, use one with:

- the ratings shown on the plug,
- a BS 1362 approval, and
- the ASTA approval mark.

Contact your dealer if you are not sure about what type of fuse to use.

Caution: To conform with the EMC directive (2004/108/EC), do not detach the plug from the power cord.

### **How to connect a plug**

The wires in the power cord are colored as follows: blue = neutral (N), brown = live (L).

If the colors do not correspond with the colors on your plug, identify the terminals in your plug as follows:

- 1** Connect the blue wire to the terminal marked N or colored black.
- 2** Connect the brown wire to the terminal marked L or colored red.
- 3** Do not connect either wire to the earth terminal in the plug, marked E (or e) or colored green (or green and yellow).

Before you replace the plug cover, make sure that the cord grip is clamped over the sheath of the cable and not just over the two wires in the cable.

### **Copyright in the U.K.**

Recording and playback of material may require consent. see Copyright Act 1956 and The performer's Protection Acts 1958 to 1972.

## 2 Your DAB+ Radio

Congratulations on your purchase, and welcome to Philips! To fully benefit from the support that Philips offers, register your product at [www.philips.com/welcome](http://www.philips.com/welcome).

Congratulations on your purchase, and welcome to Philips! To fully benefit from the support that Philips offers, register your product at [www.philips.com/welcome](http://www.philips.com/welcome).

---

### Introduction

#### With this product, you can:

- listen to FM radio stations (RDS supported),
- listen to DAB radio stations,
- listen to audio from an external device through the **AUDIO-IN** socket,
- listen to audio from an external device via Bluetooth connection.

---

### What's in the box

Check and identify the contents of the package:

- ① Digital radio
- ② User manual
- ③ Audio in cable
- ④ AC power cord
- ⑤ UK power cord

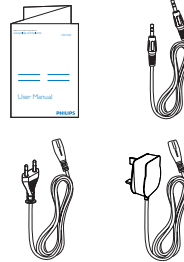
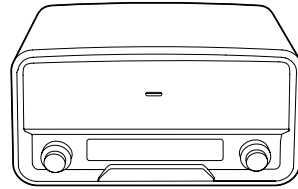

# Overview of the product

- Press to switch the system between standby mode and normal mode.
- Turn to adjust the volume.

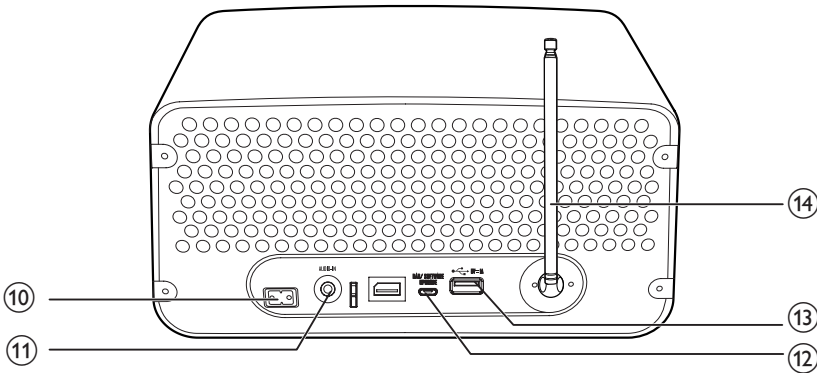
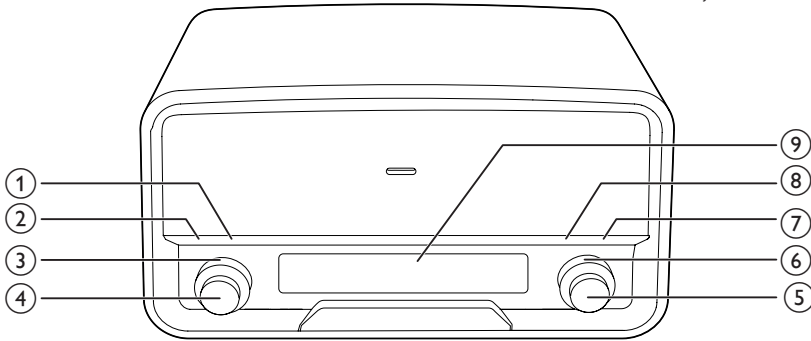

## ① INFO

- Press repeatedly to display available information.

## ② SCAN

- Press to activate the search for the next strong FM radio station.
- Press and hold to activate the automatic search for and storage of FM radio stations.

## ③ SOURCE

- Turn to select a source.
- Turn to switch the system from standby mode to normal mode.

## ④ POWER VOLUME

## ⑤ SELECT

- In FM mode, turn to tune to a radio station manually.
- Turn to toggle through FM or DAB menus.
- Under FM or DAB menu, press to enter lower level menus or confirm an option.

## ⑥ PRESET

- Turn to select a preset radio station.

## ⑦ PROGRAM

- Press to activate the programming of radio stations.

## ⑧ MENU

- Press to enter or exit FM or DAB menus.

9 LCD screen

10 AC MAIN~

- Connect to the AC power cord.

11 AUDIO IN

- Connect to an external device by an audio in cable.

12 DAB SOFTWARE

- The socket for firmware upgrade

13 ←→

- USB socket, charge the device only

14 Antenna

## 3 Get started

Always follow the instructions in this chapter in sequence.

### Connect power

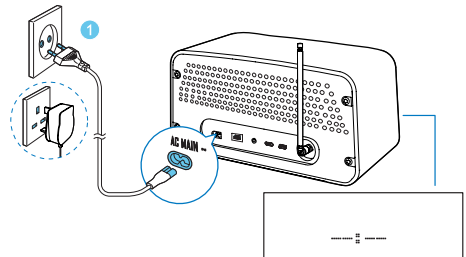

Connect the AC power cord to the **AC MAIN~** socket and then to the wall outlet.

### Turn on

Press the **POWER VOLUME** knob or turn the **SOURCE** knob.

↳ The product switches to the last selected source.

- To switch the product to standby mode, press the **POWER VOLUME** knob again.

### Set the clock

- 1 In standby mode, press and hold the **SELECT** knob for 2 seconds.  
↳ **12-Hour** (12-hour time format) or **24-Hour** (24-hour time format) blinks.
- 2 Turn the **SELECT** knob to select a time format, and then press the **SELECT** knob to confirm.  
↳ Hour digits blink.
- 3 Turn the **SELECT** knob to set the hour; and then press the **SELECT** knob to confirm.



↳ Minute digits blink.

- 4 Turn the **SELECT** knob to set the minute.
- 5 Press the **SELECT** knob to confirm.
- 6 Turn the **SELECT** knob to select whether to synchronize the DAB clock and then press the **SELECT** knob to confirm

---

## Search for a radio station automatically

Press **SCAN** to activate the auto search.

87.50MHz  
Scanning...

↳ After a strong radio station is detected, the search stops and the radio station is broadcast.

# 4 Listen to FM radio stations

- 1 Turn the **SOURCE** knob to switch the product to FM mode.
- 2 Search for radio stations automatically or manually.

### Note

- For optimal reception, fully extend the antenna and adjust its position.
- You can store a maximum of 30 FM radio stations.

---

## Search for a radio station automatically

Press **SCAN** to activate the auto search.

87.50MHz  
Scanning...

↳ After a strong radio station is detected, the search stops and the radio station is broadcast.

---

## Store radio stations automatically

Press and hold **SCAN** to activate the auto search.

- ↳ After the search is complete, the first stored radio station is broadcast.
- To tune to a stored radio station, turn the **PRESET** knob until its frequency is displayed.

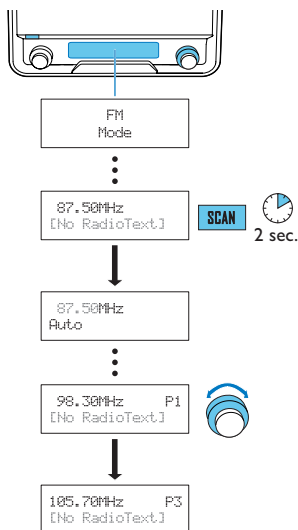

## Display RDS information

Radio Data System (RDS) is a service that allows FM stations to transmit additional information. When you tune to an FM radio station that transmits RDS signals, the station name is displayed.

- 1 Tune to an RDS station.
- 2 Press **INFO** repeatedly to scroll through the following information (if available):
  - Radio text
  - Program type such as **[NEWS]** (news), **[SPORT]** (sport), **[POP M]** (pop music)...
  - Program service
  - Mono/Stereo
  - Time
  - Date

## Program radio stations manually

- 1 Tune to a radio station.
- 2 Press the **PROGRAM** button to activate the programming.
- 3 Turn the **PRESET** knob to select a preset sequence number.
- 4 Press the **PRESET** knob to confirm.
  - ↳ The radio station is stored with the selected sequence number.
- 5 Repeat steps 1-4 to program more radio stations.
  - To tune to a preset radio station, turn the **PRESET** knob until its frequency is displayed.

### Note

- If you store a radio station with the sequence number of another one, the earlier one is overwritten.

## RDS program types

Program type	Description	Program type	Description
<b>NEWS</b>	News services	<b>FINANCE</b>	Finance
<b>AF-FAIRS</b>	Politics and current affairs	<b>CHILDREN</b>	Children's programs
<b>INFO</b>	Special information programs	<b>SOCIAL</b>	Social affairs
<b>SPORT</b>	Sports	<b>RELIGION</b>	Religion
<b>EDUCATE</b>	Education and advanced training	<b>PHONE IN</b>	Phone in
<b>Drama</b>	Radio plays and literature	<b>TRAVEL</b>	Travel
<b>CULTURE</b>	Culture, religion and society	<b>LEISURE</b>	leisure
<b>SCIENCE</b>	Science	<b>JAZZ</b>	Jazz Music
<b>VARIED</b>	Entertainment programs	<b>COUNTRY</b>	Country Music
<b>POP M</b>	Pop music	<b>NATIONAL M</b>	National Music
<b>ROCK M</b>	Rock music	<b>OLDIES</b>	Oldies Music

<b>MOR M</b>	Light music	<b>FOLK M</b>	Folk Music
<b>LIGHT M</b>	Light classical music	<b>DOCU-MENT</b>	Documen-tary
<b>CLAS-SICS</b>	Classical music	<b>TEST</b>	Alarm Test
<b>OTH-ER M</b>	Special music programs	<b>ALARM</b>	Alarm
<b>WEATHER</b>	Weather		

- **Forced mono** : Convert stereo signals to monophonic output even if the station transmits strong stereo audio signals.

3 Press the **SELECT** knob to confirm the option.

## System menus

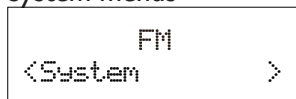

- 1 Press the **SELECT** knob to access system menus.
- 2 Turn the **SELECT** knob to select a sub-menu.
  - For details, refer to the section '**Use system menus**'.

## Adjust FM settings

- 1 In FM mode, press **MENU** to access FM menus.
- 2 Turn the **SELECT** knob to toggle through the menus.

## Scan setting

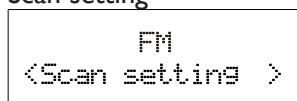

- 1 Press the **SELECT** knob to access sub-menus.
- 2 Turn the **SELECT** knob to select an option.
  - **Strong station** : Search for strong stations only.
  - **All stations** : Search for all stations no matter whether the signal strength of a station is strong or weak.
- 3 Press the **SELECT** knob to confirm the option.

## Audio setting

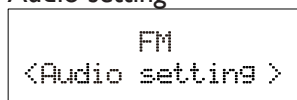

- 1 Press the **SELECT** knob to access sub-menus.
- 2 Turn the **SELECT** knob to select an option.
  - **Stereo allowed** : Allow stereo output even if the station transmits weak stereo audio signals.

# 5 Listen to DAB radio stations

## Note

- For optimal reception, fully extend the antenna and adjust its position.
- You can program a maximum of 30 DAB radio stations.
- Check with local retailer or go to [www.WorldDAB.org](http://www.WorldDAB.org) for applicable DAB radio frequencies in your area.

## For the first time use

- 1 Turn the **SOURCE** knob to switch the product to DAB mode.
- 2 Turn the **SELECT** knob until the **[Full scan]** menu is displayed.
- 3 Press the **SELECT** knob to activate the automatic search.
  - ↳ This product automatically stores radio stations with sufficient signal strength.
  - ↳ After the search is complete, the first stored radio station is broadcast automatically.
- 4 Turn the **SELECT** knob to select a station, and then press the **SELECT** knob to start listening.

## Tip

- You can re-scan to update the list of stored stations (see "Use DAB menus" > "Re-scan for stations").
- You can tune to a station manually (see "Use DAB menus" > "Tune to a station manually").

## About special symbols

Some symbol may be displayed before the name of a station.

- **H**: The station is one of your 10 favorite stations.
- **?**: The station is unavailable or inactive.
- **>>**: The station is a primary station with secondary service.
- **<<**: The station is a secondary station.

## Program radio stations

- 1 Tune to a DAB radio station.
- 2 Press **PROGRAM** to activate the programming.
- 3 Turn the **PRESET** knob to select a preset sequence number.
- 4 Press the **SELECT** knob to confirm.
  - ↳ The radio station is stored with the selected sequence number.
- 5 Repeat steps 1-4 to program more radio stations.
  - To tune to a preset radio station, turn the **PRESET** knob until its frequency is displayed.

## Note

- If you store a radio station with the sequence number of another one, the earlier one is overwritten.

## Display DAB information

On the display of DAB broadcasting, the first line shows station name, and the second line shows the service information for the current station.

Press **INFO** repeatedly to cycle through the following information (if available).

- Dynamic label segment (DLS)
- Signal strength
- Program type (PTY)
- Ensemble name
- Frequency

- Signal error rate
- Bitrate codec
- Time
- Date

---

## Use DAB menus

- 1 In DAB mode, press **MENU** to access the DAB menus.
- 2 Turn the **SELECT** knob to toggle through the menus.

---

## Tune to a stored station

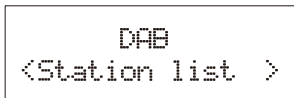

- 1 Press the **SELECT** knob to access the list of stored stations.
  - If no DAB station is stored, the product starts automatic search.
- 2 Turn the **SELECT** knob to select a station.
- 3 Press the **SELECT** knob to start listening.

---

## Re-scan for stations

Full scan is used to perform a wide range search for DAB radio stations.

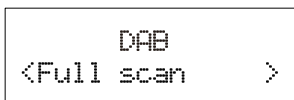

Press the **SELECT** knob to start scanning for available DAB stations.

- ↳ After the scanning is complete, the first detected station is broadcast.

---

## Tune to a station manually

With this feature, you can tune to a specific channel/frequency manually. In addition to antenna orientation for better radio reception, the optimal reception can also be obtained with this feature.

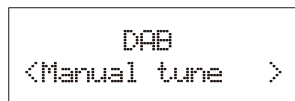

- 1 Press the **SELECT** knob to access the station list.
- 2 Turn the **SELECT** knob to select a station from 5A to 13F.



- 3 Press the **SELECT** knob to confirm the option.

---

## DRC (Dynamic Range Control)

DRC adds or removes a degree of compensation for the differences in the dynamic range between radio stations.

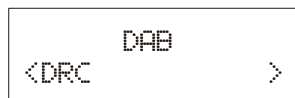

- 1 Press the **SELECT** knob to access the sub-menu.
- 2 Turn the **SELECT** knob to select an option. (The asterisk behind the option indicates the current setting.)
  - **DRC off** : No compensation applied.
  - **DRC low** : Medium compensation applied.
  - **DRC high** : Maximum compensation applied.
- 3 Press the **SELECT** knob to confirm the option.

---

## Remove invalid stations

This option lists active stations and removes any stations that are in the list but have no service in your area. In front of the station name of an invalid station, a question mark (?) is displayed.



- 1 Press the **SELECT** knob to access the sub-menus.
- 2 Turn the **SELECT** knob to select an option.
  - <No> : Return to the previous menu.
  - <Yes> : Remove invalid stations from the station list.
- 3 Press the **SELECT** knob to confirm the option.

---

## System menus

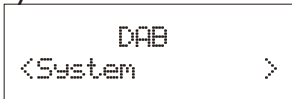

- 1 Press the **SELECT** knob to access system menus.
- 2 Turn the **SELECT** knob to select a sub-menu.
  - For details, refer to the section 'Use system menus'.

# 6 Use system menus

Use the system menus to

- check the version of current software of this product,
- upgrade the software, and
- reset the product to factory default status.

---

## Check the current software version

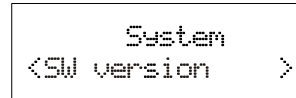

Press the **SELECT** knob to display the version of current software.

---

## Reset the product

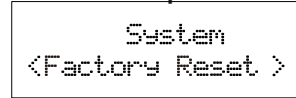

- 1 Press the **SELECT** knob to display the options.
- 2 Turn the **SELECT** knob to select an option.
  - <No> : Return to the previous menu.
  - <Yes> : Reset the product to factory default status.
- 3 Press the **SELECT** knob to confirm the option.

---

## Upgrade the software

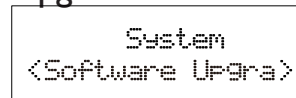

- 1 Go to [www.philips.com/support](http://www.philips.com/support).
- 2 Search for support information about your product with "**ORT7500/12**" as the keyword.
  - ↳ When an upgrade packet is available, the link of "**Firmware Upgrade Readme File**" is accessible. The exact wording of this link name may vary in different languages.
- 3 Click the link of "**Firmware Upgrade Readme File**".
- 4 Read and understand the instructions on software upgrade.
- 5 Follow the instructions to complete the upgrade.

## 7 Listen to an external device

You can also listen to an external audio device, for example, MP3 player; through this product.

- 1 Turn the **SOURCE** knob to switch the product to **AUDIO IN** mode.
- 2 Connect the audio in cable to
  - the **AUDIO IN** socket on the back panel of this product, and
  - the headphone jack on the external device.
- 3 Play the external device (refer to its user manual).

# 8 Play audio via Bluetooth

With this product, you can stream audio from a Bluetooth player.

An application **Philips DigitalRadio** is available on Apple App Store and Google Play. To fully enjoy features of this product, download and install the application to your smart device.

- 2 On your device, search for Bluetooth devices. In the device list, select **ORT7500**.
  - If a message prompts for the permission for Bluetooth connection with **ORT7500**, confirm it.

↳ If the connection succeeds, **[BT Connected]** is displayed on the LCD display of this product.
- 3 Play a track on the connected device.
  - To pause or resume play, press **▶||**.
  - To skip to the previous or next track, press **◀|▶**.

## Note

- Philips does not guarantee the compatibility with all Bluetooth devices.
- Before pairing a device with this system, read its user manual for Bluetooth compatibility.
- The product can memorize a maximum of 4 paired devices.
- Make sure that Bluetooth function is enabled on your device, and your device is set as visible to all other Bluetooth devices.
- The operational range between this system and a Bluetooth device is approximately 10 meters (30 feet).
- Any obstacle between this system and a Bluetooth device can reduce the operational range.
- Keep away from any other electronic device that may cause interference.

## Note

- **◀|▶** If the connected Bluetooth device supports the Advanced Audio Distribution Profile (A2DP), you can listen to tracks that are stored on the device through the system.
- If the device also supports the Audio Video Remote Control Profile (AVRCP), you can control play on this product.
- If the connected device does not support the AVRCP, control play on the connected device.

- 1 Turn the **SOURCE** knob to switch the product to BT mode.
  - ↳ If no Bluetooth device is connected, **[Bluetooth No Connection]** (No Bluetooth connection) scrolls.



## 9 Charge your devices

Connect your device to the **USB**  socket on the back of the product.

- ↳ Once the device is recognized, the charging starts.

### Note

- Philips does not guarantee the compatibility of this product with all devices.
- The **USB**  socket is for charging only.

## 10 Adjust the volume

Turn the **VOLUME** knob.

# 11 Product information

## Note

- Product information is subject to change without prior notice.

## General information

AC Power Rating	100-240 V~, 50/60 Hz
Operation Power Consumption	15 W
Standby power consumption	< 1 W
Dimensions (Main Unit)	325 x 175 x 167 mm
Weight (Main Unit)	3.5 kg

## Tuner

Tuning Range	FM: 87.50 - 108.00 MHz; DAB: 174.928-239.200 MHz
Tuning grid	50 kHz
DAB sensitivity (EN50248)	< -95 dbm
Total Harmonic Distortion	< 2%
Signal to Noise Ratio	> 50 dB
Number of preset radio stations	30 (FM), 30 (DAB)

## Amplifier

Rated Output Power	10 W x 2 RMS
--------------------	--------------

Frequency Response	60 Hz - 16 kHz, $\pm 3$ dB
Signal to Noise Ratio	> 65 dB
Aux Input	0.5V RMS 20 kohm

## Speakers

Speaker Impedance	6 ohm
Speaker Driver	2 X 3" full range
Sensitivity	>82 dB/m/W

## Bluetooth

Communication system	Bluetooth Standard version 2.0
Output	Bluetooth Standard Power Class 2
Maximum communication range	Line of sight approx. 10m (30 feet)
Frequency band	2.4 GHz band (2.4000 GHz - 2.4835 GHz)
Compatible Bluetooth profiles	Advanced Audio Distribution Profile (A2DP) Audio Video Remote Control Profile (AVRCP)
Supported codecs	SBC (Sub Band Codec) SBC (Sub Band Codec)
- Receive	
- Transmit	

# 12 Troubleshooting



## Warning

- Never remove the casing of this product.

To keep the warranty valid, never try to repair the product yourself.

If you encounter problems when using this product, check the following points before requesting service. If the problem remains unsolved, go to the Philips Web page ([www.philips.com/support](http://www.philips.com/support)). When you contact Philips, make sure that the product is nearby and the model number and serial number are available.

---

## General

### No power

- Make sure that the AC power cord is properly connected.
- Make sure that there is power at the AC power outlet.

### No sound

- Adjust the volume.
- When listening to an external device, make sure that the external device is not muted.

### No response from the product

- Make sure that the power is available.
- Turn off the product, and then turn it on again.

### Poor radio reception

- Due to the interference from other electrics or building obstacles, the signals become weak. Move the product to a place free of interference.
- Make sure that the antenna is fully extended. Adjust the position of the antenna.

**Clock setting is erased.**

- Power has been interrupted, or the AC power adaptor has been disconnected.
- Set the clock again.

---

## About Bluetooth connection

**Music playback is unavailable on this product even after successful Bluetooth connection.**

- The device cannot be used with this product to play music.

**The audio quality is poor after connection with a Bluetooth-enabled device.**

- The Bluetooth reception is poor. Move the device closer to this product or remove any obstacle between.

**Cannot connect with this product.**

- The device does not support the profiles required for this product.
- The Bluetooth function of the device is not enabled. Refer to the user manual of the device to find out how to enable the function.
- This product is not in the pairing mode.
- This product is already connected with another Bluetooth-enabled device. Disconnect that device and then try again.

**The paired mobile device connects and disconnects constantly.**

- The Bluetooth reception is poor. Move the device closer to this product or remove any obstacle between.
- Some mobile phones may connect and disconnect constantly when you make or end calls. This does not indicate any malfunction of this product.
- For some devices, the Bluetooth connection may be deactivated automatically as a power-saving feature. This does not indicate any malfunction of this product.

# 13 Notice

Any changes or modifications made to this device that are not expressly approved by WOOX Innovations may void the user's authority to operate the equipment.

---

## Compliance

# CE 0890

This product complies with the radio interference requirements of the European Community.

A copy of the EC declaration of Conformity is available in the Portable Document Format (PDF) version of the user manual at [www.philips.com/support](http://www.philips.com/support).



This is CLASS II apparatus with double insulation, and no protective earth provided.

---

## Care of the environment



Your product is designed and manufactured with high quality materials and components, which can be recycled and reused.



When this crossed-out wheeled bin symbol is attached to a product it means that the product is covered by the European Directive 2002/96/EC. Please inform yourself about the local separate collection system for electrical and electronic products.

Please act according to your local rules and do not dispose of your old products with your normal household waste.

Correct disposal of your old product helps to prevent potential negative consequences for the environment and human health.

### Environmental information

All unnecessary packaging has been omitted. We have tried to make the packaging easy to separate into three materials: cardboard (box), polystyrene foam (buffer) and polyethylene (bags, protective foam sheet.)

Your system consists of materials which can be recycled and reused if disassembled by a specialized company. Please observe the local regulations regarding the disposal of packaging materials, exhausted batteries and old equipment.

---

## Trademark notice

The Bluetooth® word mark and logos are registered trademarks owned by Bluetooth SIG, Inc. and any use of such marks by WOOX Innovations is under license.

---

## Copyright

2013 © WOOX Innovations Limited. All rights reserved.

Specifications are subject to change without notice. WOOX reserves the right to change products at any time without being obliged to adjust earlier supplies accordingly.









Specifications are subject to change without notice

All registered and unregistered trademarks are property of their respective owners.

2013 © WOOX Innovations Limited. All rights reserved.

Philips and the Philips' Shield Emblem are registered trademarks of Koninklijke Philips N.V. and are used by WOOX Innovations Limited under license from Koninklijke Philips N.V.

ORT7500\_10\_UM\_V2.0

