

PHILIPS

MX900 Dolby Surround Pro Logic Add-On Speaker System

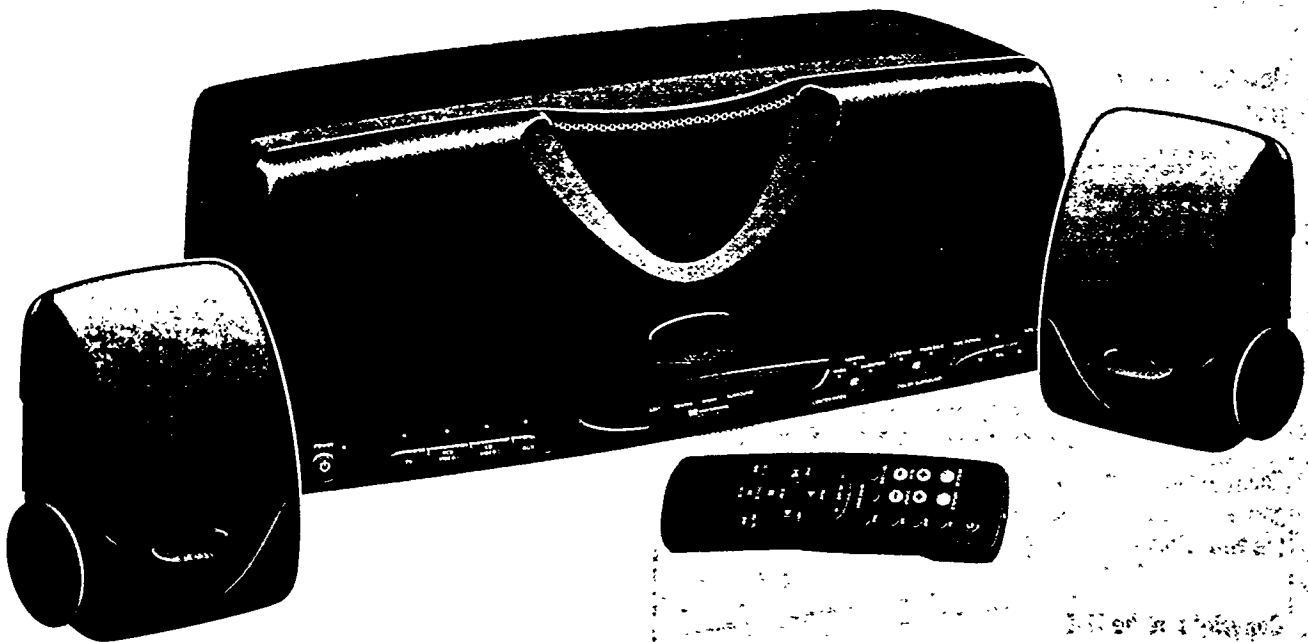

Instructions for use
Mode d'emploi
Instrucciones de manejo
Bedienungsanleitung
Gebruiksaanwijzing
Istruzioni per l'uso
Brugsanvisning
Bruksanvisning
Käyttöohje
Manual de utilização
Οδηγίες χρήσεως



PHILIPS



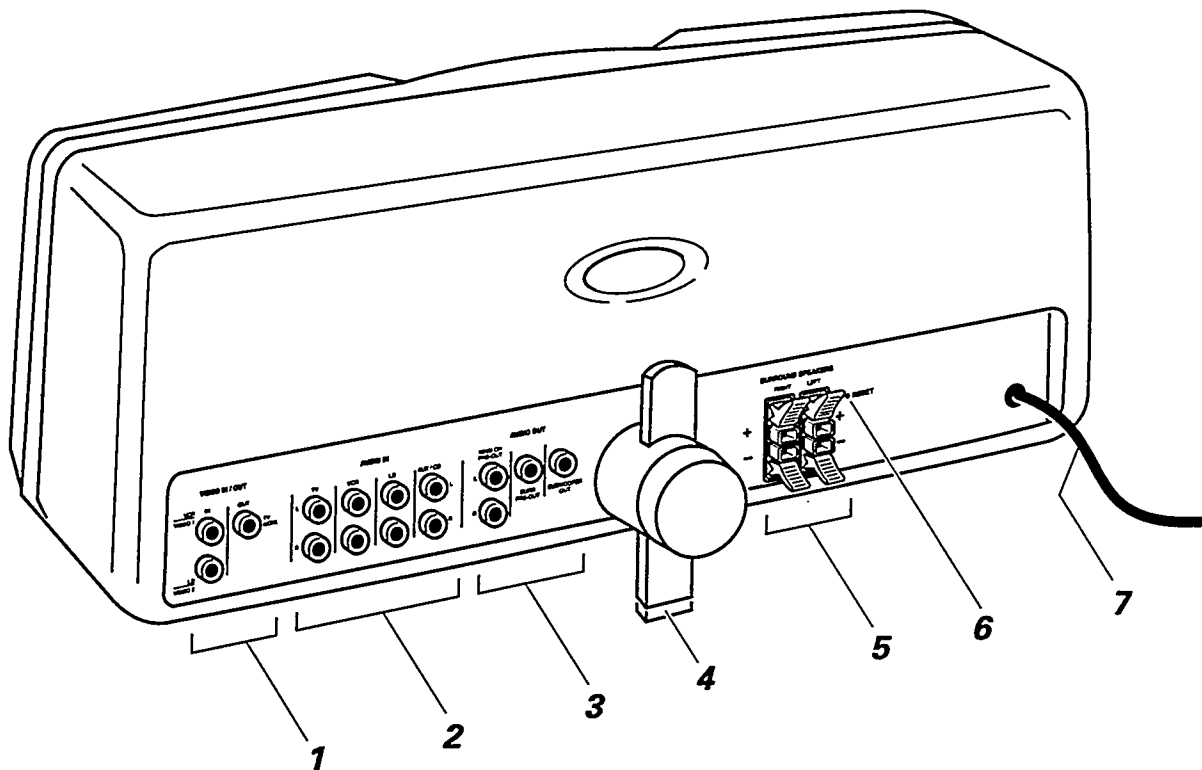
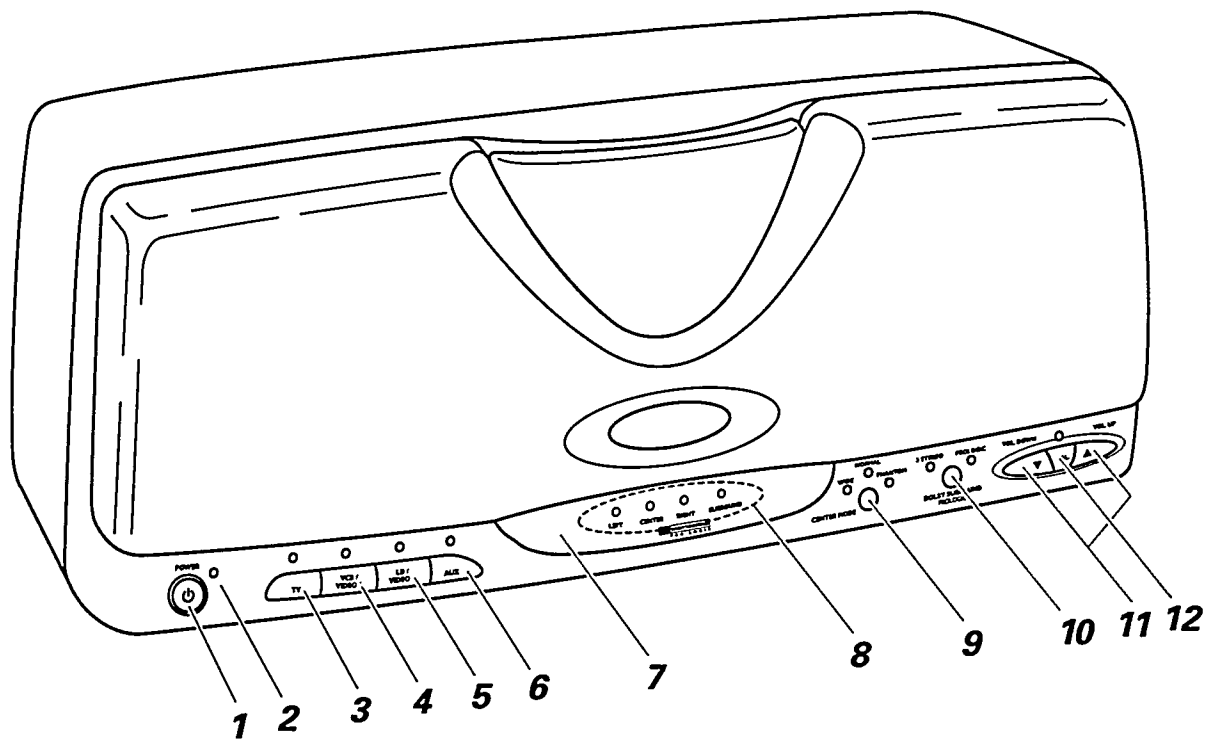

Important notes for users in the U.K.

Mains plug

This apparatus is fitted with an approved 13 Amp plug. To change a fuse in this type of plug proceed as follows:

- 1 Remove fuse cover and fuse.
- 2 Fix new fuse which should be a BS1362 5 Amp, A.S.T.A. or BSI approved type.
- 3 Refit the fuse cover.

If the fitted plug is not suitable for your socket outlets, it should be cut off and an appropriate plug fitted in its place.

If the mains plug contains a fuse, this should have a value of 5 Amp. If a plug without a fuse is used, the fuse at the distribution board should not be greater than 5 Amp.

Note: The severed plug must be disposed of to avoid a possible shock hazard should it be inserted into a 13 Amp socket elsewhere.

How to connect a plug

The wires in the mains lead are coloured with the following code: blue = neutral (N), brown = live (L).

As these colours may not correspond with the colour markings identifying the terminals in your plug, proceed as follows:

- Connect the blue wire to the terminal marked N or coloured black.
- Connect the brown wire to the terminal marked L or coloured red.
- Do not connect either wire to the earth terminal in the plug, marked E (or \perp) or coloured green (or green and yellow).

Before replacing the plug cover, make certain that the cord grip is clamped over the sheath of the lead - not simply over the two wires.

Copyright in the U.K.

Recording and playback of material may require consent. See Copyright Act 1956 and The Performer's Protection Acts 1958 to 1972.

Deutschland

Hiermit wird bescheinigt, daß dieses Gerät in Übereinstimmung mit den Bestimmungen der Amtsblattverfügung 1046/1984 funktentstört ist.

Der Deutschen Bundespost wurde das Inverkehrbringen dieses Gerätes angezeigt und die Berechtigung zur Überprüfung der Serie auf Einhaltung der Bestimmungen eingeräumt.

Norge

Typeskilt finnes på apparatens bakside.

Observer: Nettbryteren er sekundert innkoplet. Den innebygde nettdelen er derfor ikke frakoplet nettet så lenge apparatet er tilsluttet nettkontaktene.

For å redusere faren for brann eller elektrisk støt, skal apparatet ikke utsettes for regn eller fuktighet.

English.....6	English
Français.....12	Français
Español18	Español
Deutsch.....24	Deutsch
Nederlands30	Nederlands
Italiano.....36	Italiano
Svenska.....42	Svenska
Dansk.....48	Dansk
Suomi.....54	Suomi
Português.....60	Português
Ἑλληνικά66	Ἑλληνικά

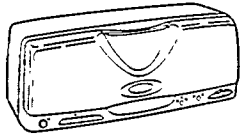

Home Theater Amplifier with built-in Center Speaker

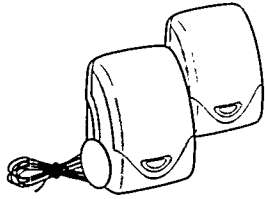

2 Surround Speakers

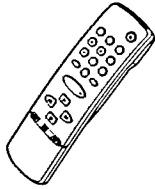

Remote control



2 Batteries for remote control



Spiral wrap for cables

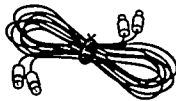

Cinch cable

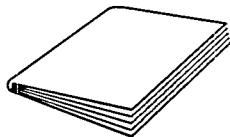

Instructions for use

Environmental information

All redundant packing material has been omitted. We have done our utmost to make the packaging easily separable into three mono materials: cardboard (box), polystyrene foam (buffer) and polyethylene (bags, protective foam sheet).

Your set consists of material which can be recycled if disassembled by a specialized company. Please observe the local regulations regarding the disposal of packing materials, exhausted batteries and old equipment.

General maintenance

Do not expose the set to humidity or rain, sand or to excessive heat caused by heating equipment or direct sunlight.

You can clean the set with a soft, slightly dampened chamois leather. Do not use any cleaning agents as they may have a corrosive effect.

This product complies with the radio interference requirements of the EU (European Union).

CONTROLS AND TERMINALS for illustration fold out cover

Controls at the front

- 1 **POWER**.....Switches the Home Theater Amplifier on and off.
- 2 **Power light**.....**RED:** Home Theater Amplifier is in standby mode.
- 3 **TV**.....Selects the TV input.
- 4 **VCR/VIDEO 1**.....Selects the VCR and the VIDEO 1 input.
- 5 **LD/VIDEO 2**.....Selects the LD and the VIDEO 2 input.
- 6 **AUX/CD**.....Selects the AUX/CD input.
- 7 Remote sensor
- 8 **LEFT, CENTER, RIGHT, SURROUND**.....Light for the corresponding speakers goes on when TEST TONE is pressed on the remote control.
- 9 **CENTER MODE**.....Selects a center mode.
NORMAL: Normal Dolby* Pro Logic and Normal Dolby 3 Stereo mode.
WIDE: Wide Dolby Pro Logic and Wide Dolby 3 Stereo mode.
PHANTOM: Phantom mode.
- 10 **DOLBY SURROUND PRO LOGIC**.....Selects a Dolby Surround Pro Logic mode.
3 STEREO: All Dolby 3 Stereo modes.
PRO LOGIC: All Dolby Pro Logic modes.

Notes: – The CENTER MODE and DOLBY SURROUND PRO LOGIC buttons are combined. If the NORMAL and 3 STEREO lights are on for instance, the Home Theater Amplifier is in Normal Dolby 3 Stereo mode.

– You cannot combine Dolby 3 Stereo with Phantom.

- 11 ▼ and ▲.....Adjusts the volume, or in combination with BALANCE to adjust the balance.
- 12 **BAL**.....To be used before ▼ and ▲ to adjust the balance between the left and right speakers.

Terminals at the back

- 1 **VIDEO IN/OUT**.....**VIDEO IN:** to connect the video output of a VCR and/or a LD.
VIDEO OUT: to connect the video input of a TV or a monitor.
- 2 **AUDIO IN**.....Input sockets:
TV: to connect the audio output of a TV.
VCR: to connect the audio output of a VCR.
LD: to connect the audio output of a LD or another VCR.
AUX/CD: to connect the audio output of a CD or another sound source.
- 3 **AUDIO OUT**.....Output sockets:
MAIN CH PRE-OUT: pre-amplified output to connect the audio input of an appliance.
SURR PRE-OUT: pre-amplified output to connect the surround input of an appliance.
SUBWOOFER OUT: to connect an active subwoofer.
- 4 Height adjustment.....Holder to support and balance the Home Theater Amplifier on inclined surfaces, e. g. on-top of your television.
- 5 **SURROUND SPEAKERS**...To connect the supplied Surround Speakers.
- 6 **RESET**.....Resets Home Theater Amplifier to its default settings.
- 7 Mains lead.....After all other connections have been made, connect the mains lead to the wall socket.

* Dolby Surround Pro Logic manufactured under license from Dolby Laboratories Licensing Corporation. "DOLBY" and the double-D symbol  are trademarks of Dolby Laboratories Licensing Corporation.

Buttons on the remote control

- STANDBY**Switches the Home Theater Amplifier to the standby mode.
- TV**Selects the TV input.
- VCR**Selects the VCR and the VIDEO 1 input.
- LD**Selects the LD and the VIDEO 2 input.
- AUX**Selects the AUX/CD input.
- PRO LOGIC**Selects the Dolby Pro Logic mode.
- 3 STEREO**Selects the Dolby 3 Stereo mode.
- CENTER MODE**Selects one of the three different center modes: Normal, Wide or Phantom.
- VOLUME + / -**Adjusts the volume.
- REAR + / -**Adjusts the volume of the Surround Speakers.
- CENTER + / -**Adjusts the volume of the Center Speaker.
- TEST TONE**Switches the test tone on.

Note: – All other buttons on the remote control can be used with appliances if they operate with the RC-5 remote control system.

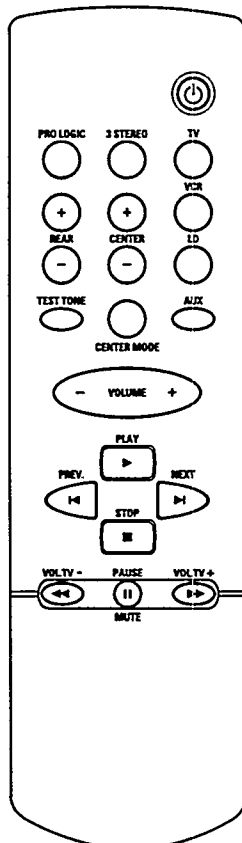

Before you start...

For users in the U.K.: please follow the instructions on page 2.

After unpacking the Home Theater Amplifier, remove all protective material.

Before connecting the Home Theater Amplifier to the mains, check if the mains voltage as shown on the type plate corresponds to your local mains voltage. If it does not, consult your local dealer or service organisation. If your Home Theater Amplifier is equipped with a voltage selector, set this selector to the local mains voltage.

To disconnect the set from the mains completely, remove the mains plug from the wall socket.

The type plate is located at the rear of the Home Theater Amplifier.

Place the Home Theater Amplifier on a hard surface, ideally on top, below, or in front of the television.

Do not cover any vents and make sure to leave a minimum of 5 centimeters (2 inches) room for ventilation.

Remote control installation

Open the battery compartment and insert the batteries supplied (type **R03, UM-4** or **AAA**) as indicated.

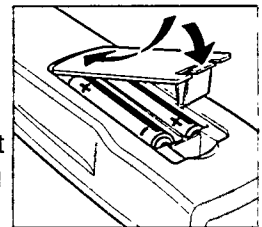

Remove the batteries if they are flat or if they will not be used for a long period of time.

Batteries contain chemical substances, so they should be disposed of properly.

Click-fit connectors

The loudspeaker terminals on the Home Theater Amplifier are click-fit connectors. Use them as shown below.

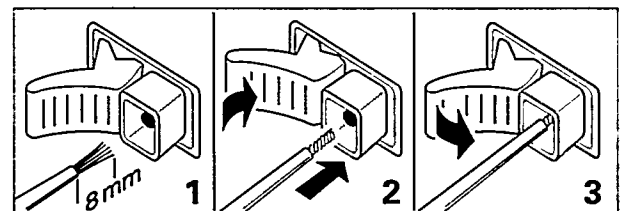

Basic connections

Important!

Always switch off all your equipment before making any connections!

- 1 Connect both Surround Speakers to the Home Theater Amplifier by connecting the unmarked wire to the red terminal, and the black marked wire to the black terminal.
- 2 Connect the AUDIO OUT (they could also be called LINE OUT or similar) sockets of your sources (TV, VCR, LD, ...) to the respective AUDIO IN sockets of the Home Theater Amplifier using cinch cables.
- 3 Connect the AUDIO IN (they could also be called LINE IN, AUX IN or similar) sockets of your audio system to the MAIN CH PRE-OUT of the Home Theater Amplifier using a cinch cable.

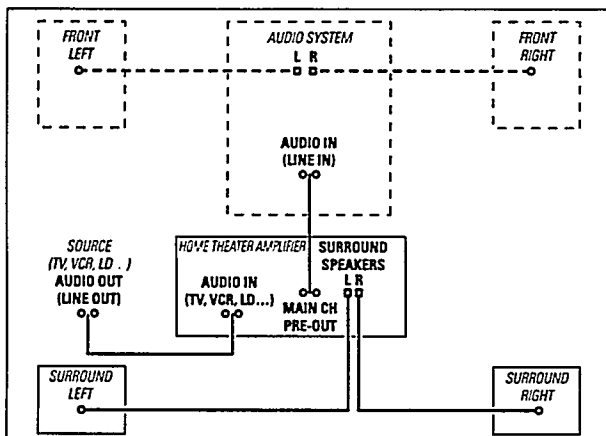

- Note:**
- The stereo speakers of your audio system will be used as front speakers.
 - After connecting all the speakers, do not forget to adjust the relative sound level between them.

Extended connections

It is possible to change both the sound source and the video source with the VCR/VIDEO 1 and LD/VIDEO 2 buttons.

- 1 Connect the VIDEO OUT of your source to a VIDEO IN on the Home Theater Amplifier. Use the video input with the same name as the audio input for this source.
- 2 Connect the VIDEO OUT of the Home Theater Amplifier to the VIDEO IN of your television.
- 3 Select the AV channel of your TV as usual.
- 4 Press VCR or LD on the Home Theater Amplifier or the remote control.
→ Sound and picture of the selected input are displayed.

Positioning of the speakers

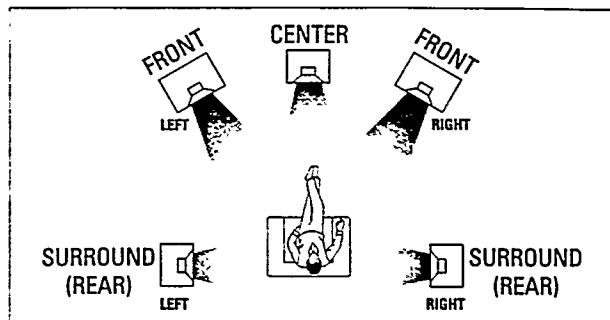

General hints for positioning

Avoid positioning the speakers in a corner or on the floor, as this will boost the bass tones too much. Placing the speakers behind curtains, furniture etc. will reduce the treble response, thus considerably reducing the stereo effect. The listener should always be able to "see" the speakers.

Each room has different acoustic characteristics and the positioning possibilities are often limited. You can find the best position for your speakers by following the picture above. The speakers should always be arranged as symmetrically as possible in the room.

Positioning the built-in Center Speaker

The Center Speaker is built into your Home Theater Amplifier. It should be placed in the center between the two front speakers, e. g. underneath or on top of the TV. The best height for the Center Speaker is at the height of the listener's ears (while seated).

Positioning the Surround Speakers

The Surround Speakers should face each other and be in line with, or at most 1.5m (5ft.) behind the listener.

Adjusting the relative speaker balance

Use the built-in test tone to set the correct balance between the Left, Right, Center, and Surround Speakers. We recommend adjusting the speaker balance at your normal listening level.

- 1 Press TEST TONE on the remote control.
→ A test tone (white sound) coming from the Left, Center, Right, and Surround Speakers will be heard.
- 2 While the CENTER light is on, adjust the sound level of the Center Speaker with the CENTER + and CENTER – buttons on the remote control.
- 3 While the SURROUND light is on, adjust the sound level of the Surround Speakers with the REAR + and REAR – buttons on the remote control.
- 4 Pressing any other button will end the test tone function.

SOUND SETTINGS

Basic sound adjustments

- 1 Switch on your audio system as usual.
- 2 Select the input used to connect the Home Theater Amplifier to your audio system.
- 3 If your source is a TV, VCR, or LD turn down the volume of your television completely. If your source is a CD player adjust its volume to a normal listening level.
- 4 Select the source used with TV, VCR, LD, or AUX on the Home Theater Amplifier or the remote control.
→ The light for the selected input on the Home Theater Amplifier goes on.
- 5 Press ▼ or ▲ on the Home Theater Amplifier, or VOLUME + or VOLUME – on the remote control to adjust the volume.
- 6 Press BAL on the Home Theater Amplifier.
→ The light above the BAL button goes on.
- 7 Then press ▼ or ▲ to adjust the balance.

Note: – Pressing BAL for more than 1 second will reset the balance.

- 8 Press CENTER + or CENTER – on the remote control to adjust the level of the Center Speaker.
- 9 Press REAR + or REAR – on the remote control to adjust the level of the Surround Speakers.

About Dolby Surround sound

Audio and video tapes and discs (video tapes, video CDs, LDs,...) with the  Dolby Surround mark are encoded for multi channel Dolby Surround sound. The DOLBY PRO LOGIC sound setting allows you to listen to audiotracks as they were recorded through the left, right, center, and rear channels.

Most ordinary stereo tapes and discs can be replayed using the Dolby Surround sound settings with good results. If the reproduction should be distorted in DOLBY PRO LOGIC mode switch to 3 STEREO or normal stereo mode.

Center modes

There are three different types of center modes to choose from. The effect is different in each mode.

Normal: This mode enables normal Dolby Surround sound reproduction.

Wide: This mode is used to add extra bass on the Center Speaker if the bass performance of all front speakers (left, center, and right) is equal.

Phantom: This mode enables listening to Dolby Surround sound without using a Center Speaker.

Dolby Surround sound modes

There are two different types of Dolby Surround sound modes to choose from. The effect is different in each mode.

Dolby Surround Pro Logic: The Dolby Surround Pro Logic mode enables normal Dolby Surround sound reproduction with 5 speakers.

Dolby 3 Stereo: In this mode the surround sound is muted and directional enhancement for surround signals is disabled. Dolby 3 Stereo enables listening to Dolby Surround sound without using Surround Speakers.

Selecting the different sound modes

You can select different sound modes by combining the different center modes with the different Dolby Surround sound modes. It is not possible to combine Phantom with Dolby 3 Stereo.

- 1 Select the source used with TV, VCR, LD, or AUX on the Home Theater Amplifier or the remote control.
→ The light for the selected input on the Home Theater Amplifier goes on.
- 2 Press DOLBY SURROUND PRO LOGIC on the Home Theater Amplifier to switch from one Dolby Surround mode to another. You can also press PRO LOGIC or 3 STEREO on the remote control for the desired sound mode.
→ The light for the selected Dolby Surround sound mode on the Home Theater Amplifier goes on.
- 3 Press CENTER MODE on the Home Theater Amplifier or the remote control to switch from one center mode to the next.
→ The light for the selected center mode on the Home Theater Amplifier goes on.
- 4 Adjust the sound settings as described in "Basic sound adjustments".

WARNING

Under no circumstances should you try to repair the set yourself, as this will invalidate the guarantee.

If a fault occurs, first check the points listed below before taking the set for repair.

If you are unable to solve a problem by following these hints, consult your dealer or service center.

PROBLEM	POSSIBLE CAUSE	SOLUTION
No sound	VOLUME is not adjusted correctly.	Adjust the VOLUME.
	Wrong input is selected.	Select the correct input.
	Speakers are not (or wrongly) connected.	Connect the speakers securely.
	Home Theater Amplifier is not connected securely to the mains.	Connect the mains cable properly.
No reaction to operation of any keys	Electrostatic discharge	Press the RESET button on the back cautiously by using an unbent paperclip.
Poor sound or no sound at the surround speakers	Surround speakers are not connected (properly).	Connect the speakers properly.
	One of the STEREO modes is selected.	Switch to DOLBY PRO LOGIC mode.
Poor bass sound	Speakers are not in phase.	Connect speakers properly; coloured cable to ⊕-pole, black marked cable to ⊖-pole.
Surround sound level is too low or too high	The level of the surround sound is not adjusted properly.	Adjust the surround sound level.
Center sound level is too low or too high	The sound level of the center channel is not adjusted properly.	Adjust the level of the center channel.

TECHNICAL DATA (subject to change without notice)

Amplifier

Standby power consumption < 10W

Output power

Surround.....25W RMS¹ / 2 × 6Ω / 1kHz / THD 10 %

Center25W RMS¹ / 3Ω / 1kHz / THD 10 %

Music Power

Surround.....45W

Center.....45W

Total harmonic distortion.....at 2W < 0.09 % at 1kHz

Power bandwidth.....60–20,000Hz, (at 10 % THD)

Frequency response60–20,000Hz, ±3dB

Surround level.....–20dB ~ +20dB to main output level

Center level.....–20dB ~ +20dB to main output level

Dimensions (h × w × d).....160 × 420 × 225mm

Weight.....approx. 4.5kg

¹ ±0.5dB

Magnetically shielded Center Speaker

Impedance.....3Ω

Frequency range.....75–20,000Hz

Drivers.....1 × 4" woofers, 1 × 2" tweeter

Surround Speakers

Impedance.....6Ω

Frequency range.....150–20,000Hz

Power handling capacity.....20W

Power handling capacity - peak.....40W

Sensitivity88dB

Drivers.....1 × 4" full range

Dimensions (h × w × d).....190 × 135 × 90mm

Weight.....approx. 0.8kg each



Meet Philips at the Internet
<http://www.philips.com>

English

Français

Español

Deutsch

Nederlands

Italiano

Svenska

Dansk

Suomi

Português

Ελληνικά

