



MMS171 Multimedia Speaker System User Guide



Website: www.philips.com/pcstuff

Caution:

Thank you for using Philips products. To assure the best working condition of the product and to prevent damage, please read this guide before use.



Caution: Dangerous voltage.

Note: Important information.

Caution

Only meant for 110V-120V

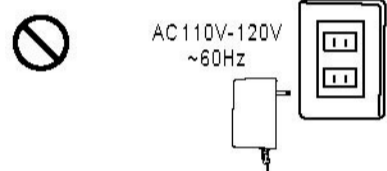

Do not use in unventilated environment or under heavy objects



Do not use during lightning.

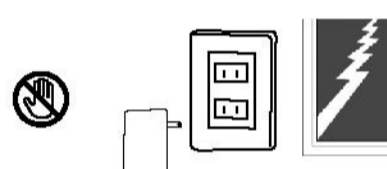

Do not put objects in the bass reflex port or ventilation port.



Characteristic and specification

Characteristic

- * Fit for music, games, movies and internet;
- * Pure timbre, good dynamic response;
- * Wooden subwoofer+2 satellite speakers;
- * Deep bass, clean treble;
- * Dynamic bass boost technology;
- * Minimize distortion for high output;
- * Dynamic bass boost;
- * With cable control to use more freely;

Specification:

- *Total electric power 26.4W
- *Power output 5.5W x 2 + 8W RMS (THD 10%)
- *frequency response 35Hz-20KHz
- *Input sensitivity 680mV
- *Harmonic Distortion: 0.3% 1W 1KHz
- *S/N: >65dB
- *Separate: >40dB
- *Driver unit: woofer 5" satellite speaker 2.5" magnetic shield
- *Audio input port: 3.5mm stereo jack
- *Audio output port: RCA jack
- *Power supply: AC110V-120V~60Hz
- *Production size: (LXWXH) Amplifier: 270x170x220 mm Speaker: 100x88x153 mm
- *packaging size: (LXWXH) 332X287X340

Placement and use

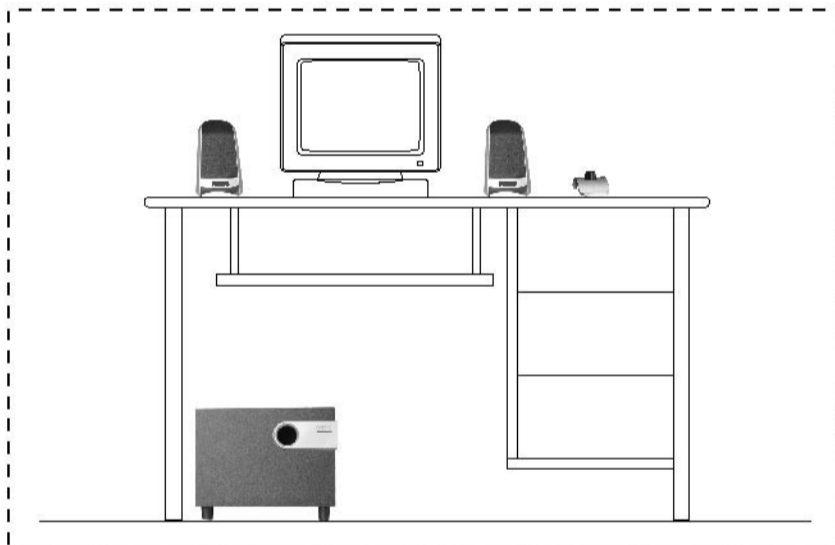

Speaker placement

MMS171 multimedia system includes 2 pieces (left and right) of satellite speakers and 1 unit of subwoofer. Put the satellite speakers on both sides of the monitor, keep their distance at approximately 70cm apart. Put the subwoofer on the floor near to PC. Adjust distance and angle for better sound effect.

Use

- 1.Minimize the volume knob on the cable control and minimize the bass knob on the side subwoofer.
- 2.Switch on the power.
- 3.Play music and adjust the knob for your comfortable volume level.

Note:

- * Do not frequently maximize volume to prevent distortion and impact on drivers and electronics.

Safety items:

If product is broken, turn off power or pull out plug

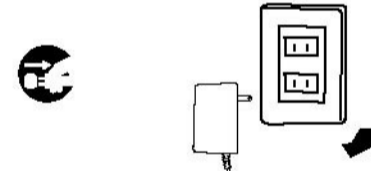

Do not splash or drop water on the products. do not put any container with water inside



Do not touch plug with wet hands

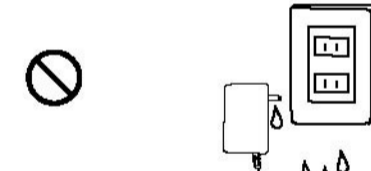

Do not break the power cable or plug



Do not personally open or disassemble the product



Do not install under strong sunlight or near any heat source

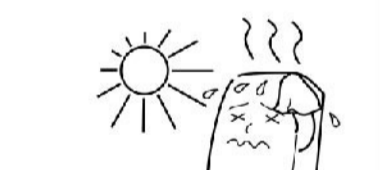

Do not always keep volume at maximum position



Do not install in dark and wet conditions.



Parts

Front view



Back view

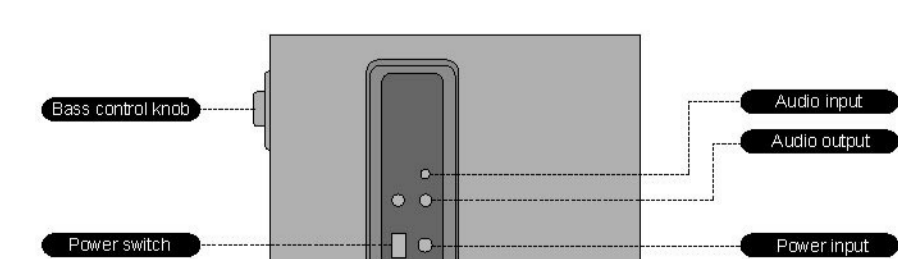

BACK VIEW OF THE SUBWOOFER

Installation

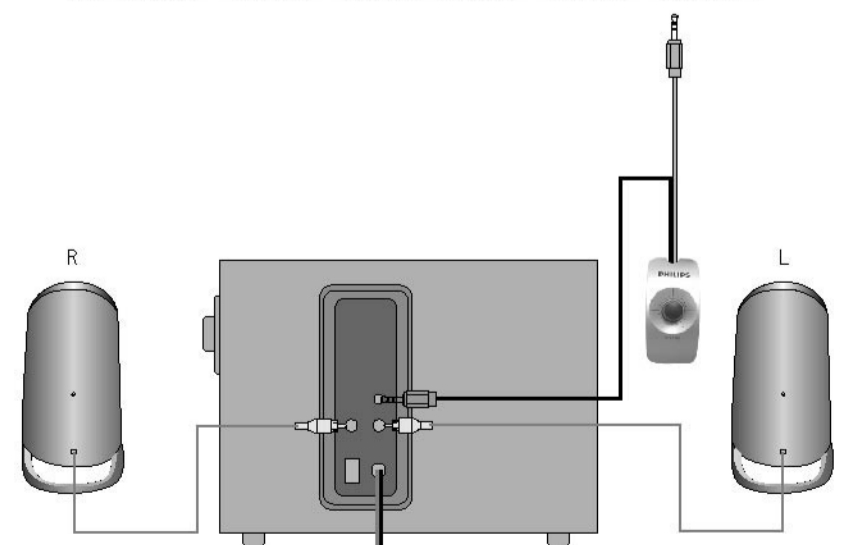
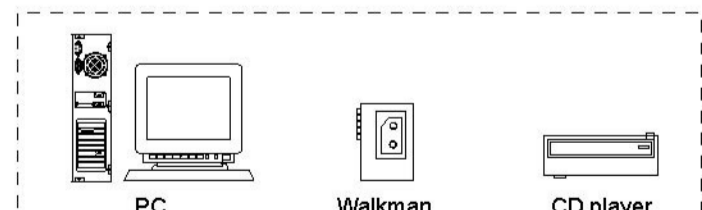

- 1.Connect both satellite speakers to the "Audio Output" connector on the side of the subwoofer And arrange speakers according to position.
- 2.Connect 3.5mm green stereo plug on the cable control to the "Audio Input" connector on the sound card (Normally marked "LINE OUT" or refer to the manual of the sound card). Connect the 3.5mm black stereo plug to the "Audio Input" connector at the back of the subwoofer.
- 3.Plug the Adaptor to the power supply outlet.

Connect AC power supply:
AC110V-120V
~60Hz

* Keep the power switched off when connecting power plug.