

## User manual



# PHILIPS

## Important notes for users in the U.K.

### Mains plug

This apparatus is fitted with an approved 13 Amp plug. To change a fuse in this type of plug proceed as follows:

- 1 Remove fuse cover and fuse.
- 2 Fix new fuse which should be a BS1362 5 Amp, A.S.T.A. or BSI approved type.
- 3 Refit the fuse cover:

If the fitted plug is not suitable for your socket outlets, it should be cut off and an appropriate plug fitted in its place.

If the mains plug contains a fuse, this should have a value of 5 Amp. If a plug without a fuse is used, the fuse at the distribution board should not be greater than 5 Amp.

**Note:** *The severed plug must be disposed of to avoid a possible shock hazard should it be inserted into a 13 Amp socket elsewhere.*

### How to connect a plug

The wires in the mains lead are coloured with the following code: blue = neutral (N), brown = live (L).

- As these colours may not correspond with the colour markings identifying the terminals in your plug, proceed as follows:
  - Connect the blue wire to the terminal marked N or coloured black.
  - Connect the brown wire to the terminal marked L or coloured red.
  - Do not connect either wire to the earth terminal in the plug, marked E (or  $\perp$ ) or coloured green (or green and yellow).

Before replacing the plug cover, make certain that the cord grip is clamped over the sheath of the lead - not simply over the two wires.

### Copyright in the U.K.

Recording and playback of material may require consent. See Copyright Act 1956 and The Performer's Protection Acts 1958 to 1972.

## CAUTION

***Use of controls or adjustments or performance of procedures other than herein may result in hazardous radiation exposure or other unsafe operation.***

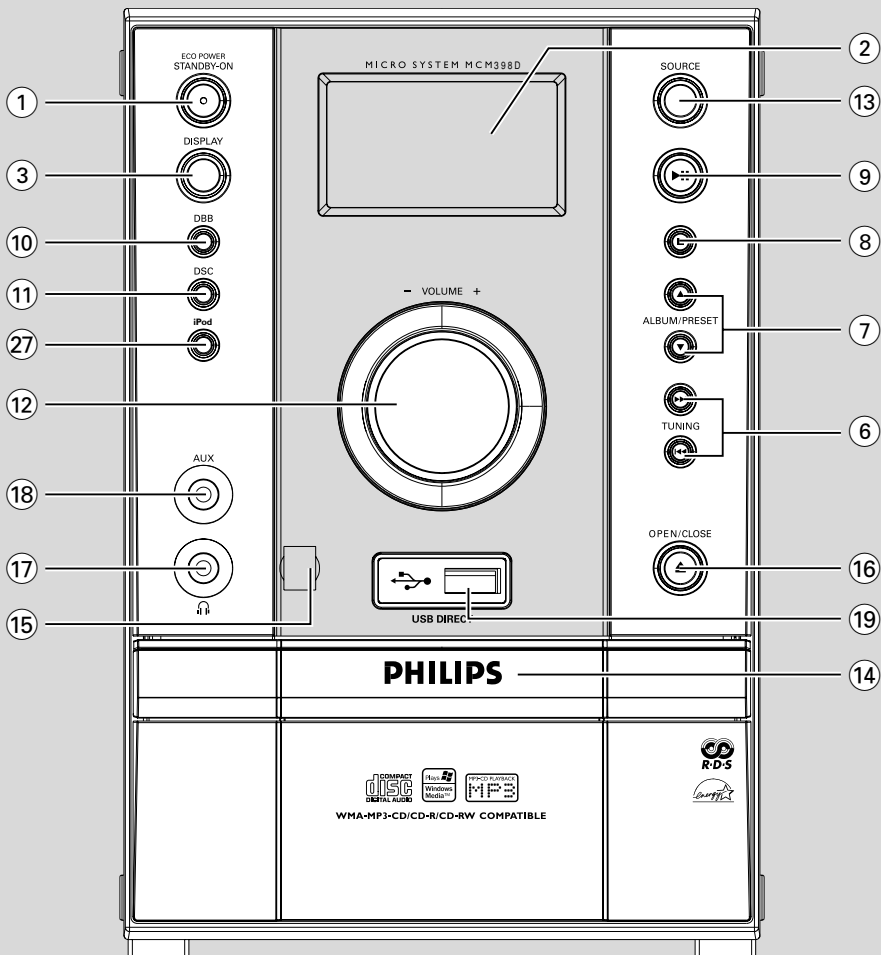

---

## General Information

Supplied accessories .....	5
Environmental information .....	5
Safety information .....	5
About MP3 disc .....	5
Hearing Safety .....	6

---

## Preparations

Rear connections .....	7–8
Power	
Antennas connection	
Speakers connection	
Optional connection	
Before using the remote control .....	8
Replacing battery (lithium CR2025) into the remote control .....	8

---

## Controls

Controls on the system and remote control .....	9–10
---	------

---

## Basic Functions

Switching the system on .....	11
Switching the system to Eco Power standby mode .....	11
Power-saving automatic standby .....	11
Volume control .....	11
Sound control .....	11

---

## CD/MP3/WMA Operations

Discs for playback .....	12
Playing a disc .....	12
Text display .....	12
Selecting a different track .....	12
Finding a passage within a track .....	13
Selecting a desired Album/Track (MP3/WMA disc only) .....	13
Different play modes: SHUFFLE and REPEAT .....	13
Programming the disc tracks .....	13
Reviewing the programme .....	13
Erasing the programme .....	13

---

## Radio Reception

Tuning to radio stations .....	14
Programming radio stations .....	14
Automatic programming	
Manual programming	
Tuning to preset radio stations .....	15
RDS .....	15
Setting the RDS clock	

---

## External Sources

Using a non-USB device .....	16
Using a USB mass storage device .....	16–17

---

## Clock/Timer

Clock setting .....	18
Timer setting .....	18
Activating and deactivating timer	
Sleep timer setting .....	18

---

## DOCK

Playing iPod using the dock.....	19
Compatible portable player	
Dock adaptor	
Selecting the correct dock adaptor	
Installing the dock adaptor	
Removing the dock adaptor	
Playing iPod	
Charging iPod battery using the dock .....	20

---

## Specifications .....

---

## Maintenance .....

---

## Troubleshooting .....

**This product complies with the radio interference requirements of the European Community.**

## Supplied accessories

- 2 speaker boxes
- remote control
- FM wire antenna
- Docking kit
  - 1 dock for Apple iPod
  - 8 dock adaptors for different iPod types

## Environmental Information

All unnecessary packaging has been omitted. We have tried to make the packaging easy to separate into three materials: cardboard (box), polystyrene foam (buffer) and polyethylene (bags, protective foam sheet).

Your system consists of materials which can be recycled and reused if disassembled by a specialised company. Please observe the local regulations regarding the disposal of packaging materials, exhausted batteries and old equipment.

## Safety Information

- Before operating the system, check that the operating voltage indicated on the typeplate (or the voltage indication beside the voltage selector) of your system is identical with the voltage of your local power supply. If not, please consult your dealer.
- Place the system on a flat, hard and stable surface.
- Place the system in a location with adequate ventilation to prevent internal heat build-up in your system. Allow at least 10 cm (4 inches) clearance from the rear and the top of the unit and 5 cm (2 inches) from each side.
- The ventilation should not be impeded by covering the ventilation openings with items, such as newspapers, table-cloths, curtains, etc.
- Do not expose the system, batteries or discs to excessive moisture, rain, sand or heat sources caused by heating equipment or direct sunlight.

- No naked flame sources, such as lighted candles, should be placed on the apparatus.
- No objects filled with liquids, such as vases, shall be placed on the apparatus.
- Install this unit near the AC outlet and where the AC power plug can be reached easily.
- If the system is brought directly from a cold to a warm location, or is placed in a very damp room, moisture may condense on the lens of the disc unit inside the system. Should this occur, the CD player would not operate normally. Leave the power on for about one hour with no disc in the system until normal playback is possible.
- The mechanical parts of the set contain self-lubricating bearings and must not be oiled or lubricated.
- **When the system is switched to Standby mode, it is still consuming some power. To disconnect the system from the power supply completely, remove the AC power plug from the wall socket.**

## About MP3 disc

### Supported formats

- ISO9660, Joliet, Multisession
- Max. track number plus album is 500
- Max. nested directory is 8 levels
- The max. album number is 99
- The max. MP3 programme track number is 20
- Supported VBR bit-rate
- Supported sampling frequencies for MP3 disc are: 32 kHz, 44.1 kHz, 48 kHz
- Supported Bit-rates of MP3 disc are: 32, 64, 96, 128, 192, 256 (kbps)

### Sound Quality

Take note that MP3-CD compilations should best contain only MP3 tracks (.mp3). **To achieve a good MP3 quality, a bit rate of 128 kbps is recommended.**

## Hearing Safety

### Listen at a moderate volume.

- Using headphones at a high volume can impair your hearing. This product can produce sounds in decibel ranges that may cause hearing loss for a normal person, even for exposure less than a minute. The higher decibel ranges are offered for those that may have already experienced some hearing loss.
- Sound can be deceiving. Over time your hearing "comfort level" adapts to higher volumes of sound. So after prolonged listening, what sounds "normal" can actually be loud and harmful to your hearing. To guard against this, set your volume to a safe level before your hearing adapts and leave it there.

### To establish a safe volume level:

- Set your volume control at a low setting.
- Slowly increase the sound until you can hear it comfortably and clearly, without distortion.

### Listen for reasonable periods of time:

- Prolonged exposure to sound, even at normally "safe" levels, can also cause hearing loss.
- Be sure to use your equipment reasonably and take appropriate breaks.

### Be sure to observe the following guidelines when using your headphones.

- Listen at reasonable volumes for reasonable periods of time.
- Be careful not to adjust the volume as your hearing adapts.
- Do not turn up the volume so high that you can't hear what's around you.
- You should use caution or temporarily discontinue use in potentially hazardous situations.
- Do not use headphones while operating a motorized vehicle, cycling, skateboarding, etc.; it may create a traffic hazard and is illegal in many areas.

### Disposal of your old product

Your product is designed and manufactured with high quality materials and components, which can be recycled and reused.



When this crossed-out wheeled bin symbol is attached to a product it means the product is covered by the European Directive 2002/96/EC

Please inform yourself about the local separate collection system for electrical and electronic products.

Please act according to your local rules and do not dispose of your old products with your normal household waste. The correct disposal of your old product will help prevent potential negative consequences for the environment and human health.

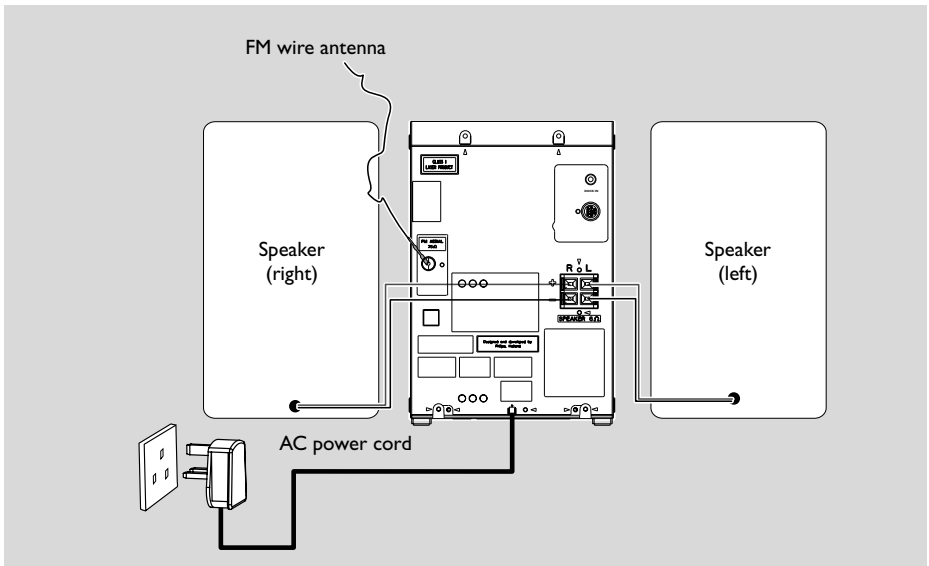

## Rear connections

The **type plate** is located at the rear of the system.

For users in the U.K.: please follow the instructions on page 2.

### (A) Power

- Before connecting the AC power cord to the wall outlet, ensure that all other connections have been made.

#### WARNING!

- For optimal performance, use only the original power cable.
- Never make or change connections with the power switched on.

To avoid overheating of the system, a safety circuit has been built in. Therefore, your system may switch to Standby mode automatically under extreme conditions. If this happens, let the system cool down before reusing it (not available for all versions).

### (B) Antenna Connection

Connect the supplied FM antenna to the **FM AERIAL** terminal. Adjust the position of the antenna for optimal reception.

#### FM Antenna

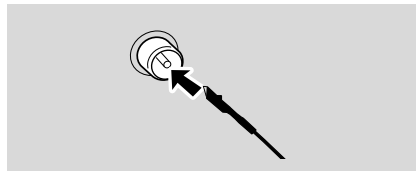

- For better FM stereo reception, connect an outdoor FM antenna to the FM AERIAL (FM ANTENNA) terminal.

### (C) Speakers Connection

#### Front Speakers

Connect the speaker wires to the SPEAKERS terminals, right speaker to "R" and left speaker to "L", coloured (marked) wire to "+" and black (unmarked) wire to "-".

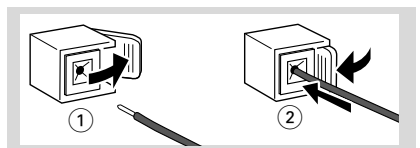

## Preparations

- Fully insert the stripped portion of the speaker wire into the terminal as shown.

### Notes:

- For optimal sound performance, use the supplied speakers.
- Do not connect more than one speaker to any one pair of  $+/-$  speaker terminals.
- Do not connect speakers with an impedance lower than the speakers supplied. Please refer to the SPECIFICATIONS section of this manual.
- Position FM antenna as far as possible from the speaker wires to avoid interference.

### D Optional connection

The optional equipment and connecting cords are not supplied. Refer to the operating instructions of the connected equipment for details.

#### Connecting a USB device or memory card

By connecting a USB mass storage device (including USB flash memory, USB flash players or memory cards) to the Hi-Fi system, you can enjoy the device's stored music through the powerful speakers of Hi-Fi system.

- Insert the USB device's USB plug into the  socket on the set.

OR

#### for the devices with USB cables:

- 1 Insert one plug of the USB cable (not supplied) to the  socket on the set.
- 2 Insert the other plug of the USB cable to the USB output terminal of the USB device.

OR

#### for the memory card:

- 1 Insert the memory card into a card reader (not supplied).
- 2 Use a USB cable (not supplied) to connect the card reader into the  socket on the set.

#### Connecting a non-USB device

Use a cinch cable to connect **AUX** to the analogue audio out terminals of an external equipment (TV, VCR, Laser Disc player, DVD

player or CD Recorder).

### Note:

- If you are connecting equipment with a mono output (a single audio out terminal), connect it to the AUX left terminal. Alternatively, you can use a "single to double" cinch cable (the output sound still remain mono).

### Before using the remote control

- 1 Pull out the plastic protective sheet.
- 2 Select the source you wish to control by pressing one of the source select keys on the remote control (for example CD, FM).
- 3 Then select the desired function (for example .

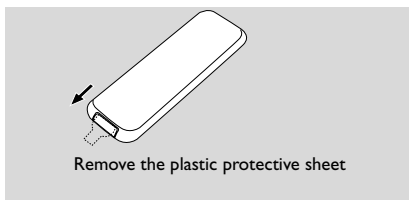

### Replacing battery (lithium CR2025) into the remote control

- 1 Press the slot on the battery compartment.
- 2 Pull out the battery compartment.
- 3 Replace a new battery and fully insert the

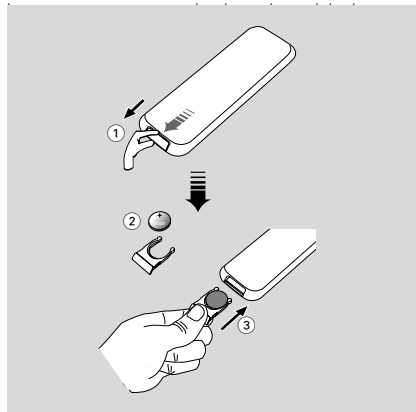

### CAUTION!

**Batteries contain chemical substances, so they should be disposed of properly.**



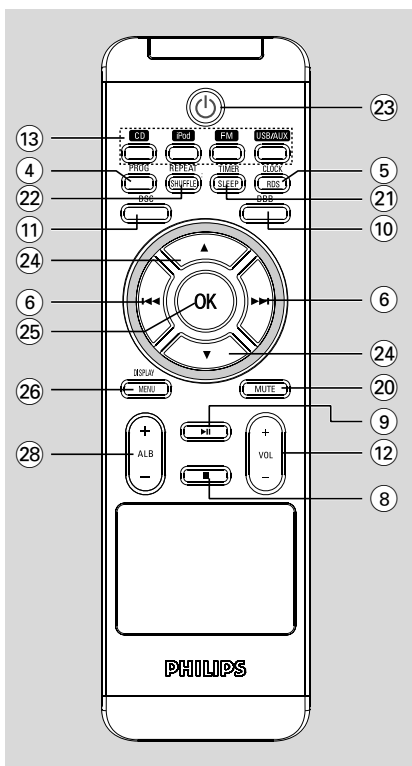

## Controls on the system and remote control

- ① **Eco Power/STANDBY-ON**

  - to switch the system on or to Eco Power standby mode.

- ② **Display screen**

  - to view the current status of the system.

- ③ **DISPLAY**

  - to display track information during playback.

- ④ **PROG**

  - for CD/MP3/WMA/USB
  - ..... to programme disc tracks.
  - for FM ..... to programme preset radio stations.

- ⑤ **Clock/RDS**

  - for FM ..... to activate RDS news.
  - for clock..... to set the clock function.

- ⑥ **TUNING**

  - for CD/MP3/WMA/USB/iPod
  - ..... to select a desired track.
  - ..... (press and hold) to search backward/forward.
  - for FM ..... to tune to a lower or higher radio frequency.

- ⑦ **ALBUM/PRESET**

  - for MP3/WMA/USB
  - ..... to select previous/next album.
  - for FM ..... to select a preset radio station.

- ⑧

  - for CD/MP3/WMA/USB
  - ..... to stop playback or to clear a programme.

- ⑨

  - for CD/MP3/WMA/USB/iPod
  - ..... to start or interrupt playback.

- ⑩ **DBB (Dynamic Bass Boost)**

  - to enhance the bass.

- ⑪ **DSC (Digital Sound Control)**

  - to select the desired sound effect : POP, JAZZ, CLASSIC or ROCK.

- ⑫ **VOLUME - / + (VOL + / -)**

  - to increase or decrease the volume.
  - to adjust the hours and minutes for the clock/ timer functions.

- ⑬ **SOURCE**

  - to select the respective sound source : CD, iPod, FM, USB/AUX.

- ⑭ **Disc tray**
- ⑮ **iR sensor**

  - infrared sensor for remote control.

- ⑯ **OPEN/CLOSE**

  - to open or close the disc tray.

- ⑰

  - plugs in a headphone.

- ⑱ **AUX**

  - to connect an auxiliary device.

- ⑲ **USB DIRECT**

  - jack for the external USB mass storage device.

## Controls (main set illustrations on page 3)

- ⑳ **MUTE**
  - to interrupt and resume sound reproduction.
- ㉑ **TIMER/SLEEP**
  - to activate/deactivate the timer function.
  - to activate/deactivate or set the sleep timer.
- ㉒ **REPEAT/SHUFFLE**
  - to play track(s)/program repeatedly.
  - to turn on/off the random play mode.
- ㉓ **⏻**
  - to switch the system to standby mode.
- ㉔ **▲ / ▼**
  - for iPod..... to select an item in a menu.
  - for FM..... to select a preset radio station
- ㉕ **OK**
  - to confirm a selection (for iPod menu operation only).
- ㉖ **DISPLAY/MENU**
  - for CD/MP3/WMA  
..... to display track information during playback.
  - for iPod..... is equivalent to the MENU button on your iPod player.
- ㉗ **iPod**
  - to select iPod source.
- ㉘ **ALB +/-**
  - for MP3/WMA/USB  
..... to select previous/next album.

### **Notes for remote control:**

- **First select the source you wish to control by pressing one of the source select keys on the remote control (for example CD, FM).**
- **Then select the desired function (for example ► II, ◀◀◀, ▶▶▶).**

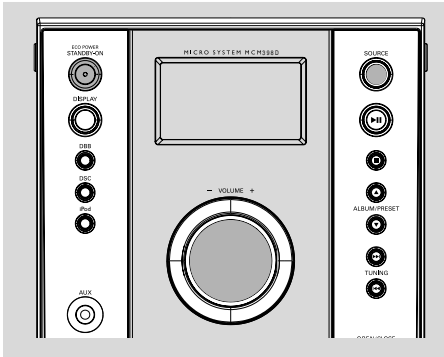



## IMPORTANT!

Before you operate the system, complete the preparation procedures.

## Switching the system on

- Press **Eco Power/STANDBY-ON**  or **SOURCE** on the main set.  
→ The system will switch to the last selected source.
- Press **CD, iPod, FM, or USB/AUX** on the remote control.  
→ The system will switch to the selected source.

## Switching the system to Eco Power Standby mode

- Press **Eco Power/STANDBY-ON**  in the active mode.  
→ The backlight of clock display is dim in standby.
- The volume level (up to a maximum volume level of 12) interactive sound settings, last selected mode, source and tuner presets will be retained in the player's memory.
- To view the clock time in Standby mode, press and hold **Eco Power/STANDBY-ON**  for 3 seconds or more.  
→ The system enters the normal standby mode with clock display.  
→ If the clock has not been set, "----:--" is displayed.
- Press and hold **Eco Power/STANDBY-ON**  for 3 seconds or more to go back to Eco Power Standby mode.

## Power-saving automatic standby

As a power-saving feature, the system will automatically switch to Standby mode if you do not press any buttons within 15 minutes after a disc has stopped playing.

## Volume control

Adjust **VOLUME +/- (VOL + / -)** to increase or decrease the volume level.

→ Display shows the volume level "VOL" and a number from 1-31. "MIN" denotes the minimum volume level and "MAX" denotes the maximum volume level.

## To switch off the volume temporarily

- Press **MUTE** on the remote control.  
→ Playback will continue without sound and "MUTE" is displayed.
- To restore the volume, press **MUTE** again or increase/decrease the volume level.

## Sound control

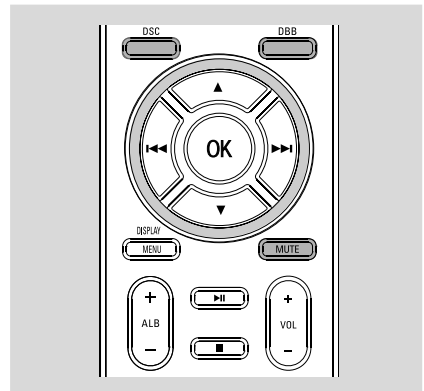

- Press **DSC** repeatedly to select the desired sound effect: **POP, JAZZ, CLASSIC** or **ROCK**.
- Press **DBB** to switch on or off the bass enhancement.  
→ If the DBB is activated, **DBB ON** is shown briefly.  
→ If the DBB is deactivated, **DBB OFF** is shown briefly.

# CD/MP3/WMA Operations

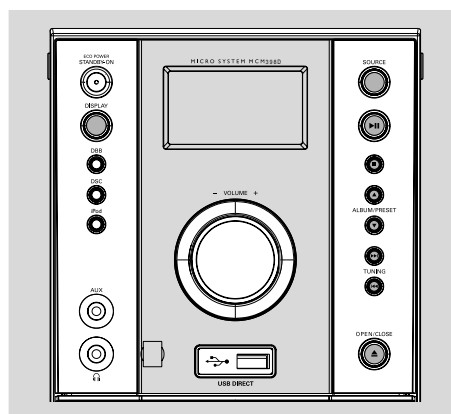

## Discs for playback

This system is able to play :

- All pre-recorded audio CDs
  - All finalised audio CDR and audio CDRW discs
  - MP3-CDs (CD-ROMs with MP3 tracks)
- CD-ROM, CD-I, CDV, VCD, DVD or computer CDs, however, are not possible.

## Playing a disc

- 1 Select **CD** source.
- 2 Press **OPEN/CLOSE ▲** on the front panel to open the CD compartment.  
→ "CD OPEN" is displayed.
- 3 Insert a disc with the printed side facing up and press **OPEN/CLOSE ▲** to close the CD door.  
→ "RETRIVING" is displayed as the CD player scans the contents of a disc, and then the total number of tracks and playing time (or the total number of albums and tracks for MP3 disc) are shown.
- 4 Press **▶||** to start playback.

### To interrupt playback

- Press **▶||**.
- To resume playback, press **▶||** again.

### To stop playback

- Press **■**.

### Notes:

- Disc play will also stop when you select another source or the disc has reached the end.
- For MP3 disc, the disc reading time may exceed 10 seconds due to the large number of songs compiled into one disc.

## Text display

### During CD playback

- Press **DISPLAY** (or **DISPLAY/MENU** on the remote control) repeatedly to see the following information.
  - Track number and remaining playback time of current track.
  - Track number and elapsed playback time of current track.
  - Track number and total remaining playback time.
  - Track number and total elapsed playback time.

### During MP3/WMA-CD playback

- Press **DISPLAY** (or **DISPLAY/MENU** on the remote control) repeatedly to select three display modes : Track, Album and ID3.
  - Track** → The current track name scrolls.
  - Album** → The current album name scrolls.
  - ID-3** → The ID-3 tag scrolls (if any).

## Selecting a different track

- Press **TUNING |◀◀ / ▶▶|** (or **|◀◀▶▶|** on the remote control) repeatedly until the desired track number appears in the display.
- If playback is stopped, press **▶||** to start playback.

## Finding a passage within a track

- 1 Press and hold down on **TUNING** |◀◀ / ▶▶| (or |◀◀▶▶| on the remote control).  
→ The disc is played at high speed.
- 2 When you recognize the passage you want, release **TUNING** |◀◀ / ▶▶| (or |◀◀▶▶| on the remote control).  
→ Normal playback continues.

## Selecting a desired album/track (MP3/WMA disc only)

### To select a desired album

- Press **ALBUM/PRESET** ▼ / ▲ (or **ALB +/-** on the remote control) repeatedly.

### To select a desired track

- Press **TUNING** |◀◀ / ▶▶| (or |◀◀▶▶| on the remote control) repeatedly.

## Different play modes: SHUFFLE and REPEAT

You can select and change the various play modes before or during playback.

- 1 Press **REPEAT/SHUFFLE** on the remote control to select :  
→ **SHUF** – tracks of the entire disc/ programme are played in random order.  
→ **SHUF REP ALL** – to repeat the entire disc/ programme continuously in random order.  
→ **REP ALL** – to repeat the entire disc/ programme.  
→ **REP** – to repeat the current track.
- 2 To return to normal playback, press **REPEAT/SHUFFLE** until the various SHUFFLE/REPEAT modes are no longer displayed.
- You can also press ■ to cancel your play mode.

### Note:

– If Shuffle is activated on an MP3-CD, all titles stored in the disc will be played in random order.

## Programming the disc tracks

Programming tracks is possible when playback is stopped. Up to 20 tracks can be stored in the memory in any order.

- 1 Press **PROG** on the remote control to enter the programming mode.  
→ A track number is shown and **PROG** flashes.
- 2 Press **TUNING** |◀◀ / ▶▶| (or |◀◀▶▶| on the remote control) repeatedly to select your desired track number.
- For MP3 disc, press **ALBUM/PRESET** ▼ / ▲ (or **ALB +/-** on the remote control) and **TUNING** |◀◀ / ▶▶| (or |◀◀▶▶| on the remote control) to select the desired album and track for programming.
- 3 Press **PROG** to confirm the track number to be stored.
- 4 Repeat steps 2-3 to select and store all desired tracks.
- 5 To start playback of your disc programme, press ■ followed by ▶ II.
- If you attempt to programme more than 20 tracks, "FULL" will appear on the display. In this case :  
→ The system will exit programming mode automatically.  
→ Pressing ■ button will erase all the programmed tracks.  
→ Pressing ▶ II button will start playback of the programmed tracks.

## Reviewing the programme

In stop mode, press and hold **PROG** until the display shows all your stored track numbers in sequence.

## Erasing the programme

- Press ■ **once** when playback is stopped or **twice** during playback.  
→ **PROG** disappears and "CLEAR" is displayed.

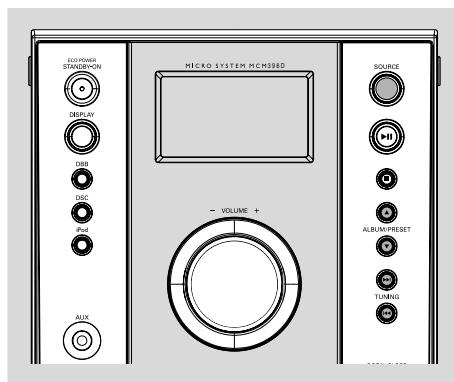

## Tuning to radio stations

- 1 Press **SOURCE** on the front panel repeatedly (or **FM** on the remote control) to select FM.
- 2 Hold **TUNING** |◀◀/▶▶| (or |◀◀▶▶| on the remote control) and then release the button.  
→ The display will show "SEARCH" until a radio station with sufficient signal strength is found.  
→ If a FM station is received in stereo, ∞ is shown.
- 3 Repeat step 2 if necessary until you find the desired station.
- To tune to a weak station, press **TUNING** |◀◀/▶▶| (or |◀◀▶▶| on the remote control) briefly and repeatedly until you have found optimal reception.

## Programming radio stations

You can store up to 40 radio stations in the memory.

### Automatic programming

Automatic programming will start with a chosen preset number. From this preset number upwards, former programmed radio stations will be overridden.

- 1 Press **ALBUM/PRESET** ▼ / ▲ to select the preset number where programming should start.

**Note:**

– If no preset number is selected, default is preset (1) and all your presets will be overridden.

- 2 Press **PROG** on the remote control for more than two seconds to activate programming.  
→ All available stations are programmed.

### Manual programming

- 1 Tune to your desired station (refer to "Tuning to radio stations").
- 2 Press **PROG** to activate programming.  
→ **PROG** flashes in the display.
- 3 Press **ALBUM/PRESET** ▼ / ▲ to allocate a number from 1 to 40 to this station.
- 4 Press **PROG** again to confirm the setting.  
→ **PROG** disappears, the preset number and the frequency of the preset station are shown.
- 5 Repeat the above four steps to store other stations.
- You can override a preset station by storing another frequency in its place.

## Tuning to preset radio stations

- Press **ALBUM/PRESET ▼ / ▲** until the desired preset station is displayed.

## RDS

**Radio Data System** is a service that allows FM stations to show additional information. If you are receiving a RDS station, **RDS** and the station name are displayed.

When automatic programming is used, RDS stations will be programmed first.

### Scrolling through different RDS information

- Press **CLOCK/RDS** on the remote control briefly and repeatedly to scroll through the following information (if available):
  - Station name
  - Radio text messages
  - Frequency

### Setting the RDS clock

Some RDS radio station may be transmitting a real clock time at an interval of every minute. It is possible to set the clock by using a time signal which is broadcast together with the RDS signal.

- 1 Tune to a RDS station (refer to "Tuning to radio stations").
- 2 Press **CLOCK/RDS** for more than two seconds.
  - "SERR TM" is displayed.
  - When RDS time is read, "RDS" and RDS time value are displayed and the current time will be stored.

#### Note:

– Some RDS radio station may be transmitting a real time clock at a minute interval. The accuracy of the transmitted time depends on the transmitting RDS radio station.

# External Sources

## Using a non-USB device

- 1 Connect the audio out terminals of the external equipment (TV, VCR, Laser Disc player, DVD player or CD Recorder) to the AUX terminals of your system.
- 2 Press **SOURCE** repeatedly (or **USB/AUX** on the remote control) to select external equipment.

### Note:

- All the sound control features (DSC or DBB, for example) are available for selection.
- Refer to the operating instructions for the connected equipment for details.

## Using a USB mass storage device

By connecting a USB mass storage device to the Hi-Fi system, you can enjoy the device's stored music through the powerful speakers of Hi-Fi system.

### Playing a USB mass storage device Compatible USB mass storage devices

With the Hi-Fi system, you can use:

- USB flash memory (USB 2.0 or USB1.1)
- USB flash players (USB 2.0 or USB1.1)
- memory cards (requires an additional card reader to work with this Hi-Fi system)

### Note:

- In some USB flash players (or memory devices), the stored contents are recorded using copyright protection technology. Such protected contents will be unplayable on any other devices (such as this Hi-Fi system).

### Supported formats:

- USB or memory file format FAT12, FAT16, FAT32 (sector size: 512 bytes)
- MP3 bit rate (data rate): 32-320 Kbps and variable bit rate
- WMA v9 or earlier
- Directory nesting up to a maximum of 8 levels
- Number of albums/ folders: maximum 99
- Number of tracks/titles: maximum 500
- ID3 tag v2.0 or later
- File name in Unicode UTF8 (maximum length: 128 bytes)

### The system will not play or support the following:

- Empty albums: an empty album is an album that does not contain MP3/WMA files, and will not be shown in the display.
- Non-supported file formats are skipped. This means that e.g.: Word documents .doc or MP3 files with extension .dlf are ignored and will not be played.
- AAC, WAV, PCM audio files
- DRM protected WMA files
- WMA files in Lossless format

### How to transfer music files from PC to a USB mass storage device

By dragging and dropping music files, you can easily transfer your favorite music from PC to a USB mass storage device.

For the flash player, you can also use its music management software for the music transfer.

**However, those WMA files may be unplayable for compatibility reasons.**



## How to organize your MP3/WMA files on the USB mass storage device

This Hi-Fi system will browse the MP3/WMA files in the folders/sub-folders/titles order:

Example:

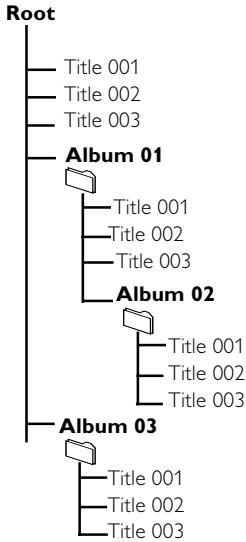

Organize your MP3/WMA files in different folders or subfolders as required.

### Notes:

- If you have not organized MP3/WMA files into any albums on your disc, an album "01" will be automatically assigned for all those files.
- Make sure that the file names of MP3 files end with .mp3. and the file names of WMA files end with .wma.
- For DRM protected WMA files, use Windows Media Player 10 (or later) for conversion. Visit [www.microsoft.com](http://www.microsoft.com) for details about Windows Media Player and WM DRM (Windows Media Digital Rights Management).

- 1 Check the USB device has been properly connected. (See Installation: Connecting an additional appliance).
- 2 Press **SOURCE (USB/AUX)** on the remote) once or more to select USB.
  - **NO TRACK** appears if no audio file is found in the USB device.

- 3 Play the USB's audio files as you do with the albums/tracks on a CD (See CD/MP3/WMA Operations).

### Notes:

- For compatibility reasons, the album/track information may differ from what it is displayed through flash players' music management software.
- File names or ID3 tags will be displayed as — if they are not in English.

### IMPORTANT!

#### Compatibility of the USB connection on this product:

- This product supports most USB Mass storage devices (MSD) that are compliant to the USB MSD standards.
  - Most common Mass storage class devices are flash drives, memory sticks, jump drives and etc.
  - If you see a "Disc Drive" show up on your computer after you plugged the mass storage device into your computer, most likely it is MSD compliant and it will work with this product.
- If your Mass storage device required a battery/power source. Please make sure you have a fresh battery in it or charge the USB device first and then plug it into the product again.

#### Supported Music type:

- This device only supports unprotected music with the following file extension:
  - .mp3
  - .wma
- Music bought from on-line music stores are not supported because they are secured by Digital Rights Management protection (DRM).
- File name extensions that end with the following are not supported:
  - .wav; .m4a; .m4p; mp4; .aac and etc.

**No Direct connection can be made from Computer USB port to the product even you have either or both mp3 or wma files in your computer.**

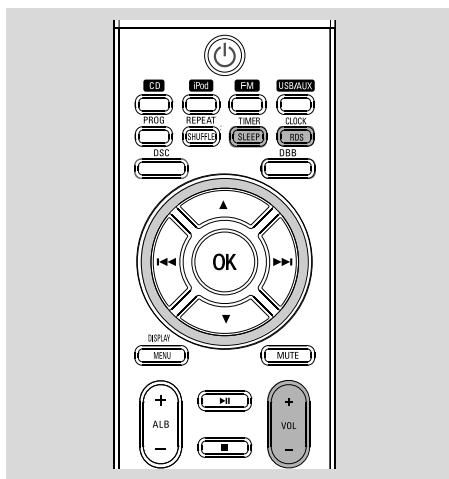

## Clock setting

There are two possible methods for setting the clock: manually or automatically by using RDS.

### Automatic clock setting

Refer to "Setting the RDS clock".

### Manual clock setting

The clock can be set in either 12-hour or 24-hour mode ("FM 12:00" or "00:00" for example).

- 1 In standby mode, press and hold **CLOCK/RDS** on the remote control.  
→ **SET CLOCK** is displayed briefly. Then, the clock digits for the hours flash.
- 2 Press **■** on the remote control to select clock mode.  
→ "12 TO 24 HOUR" or "24 TO 12 HOUR" scrolls once. Then, the clock digits for the hours continue to flash.
- 3 Adjust **VOLUME +/-** (or press **VOL +/-** on the remote control) to set the hours.
- 4 Press **CLOCK/RDS** again.  
→ The clock digits for the minutes flash.
- 5 Adjust **VOLUME +/-** (or press **VOL +/-** on the remote control) to set the minutes.
- 6 Press **CLOCK/RDS** to confirm the time.

## Timer setting

- The system can be used as an alarm clock, whereby the CD, FM or USB is switched on at a set time (one time operation). The clock time

needs to be set first before the timer can be used.

- During setting, if no button is pressed within 90 seconds, the system will exit timer setting mode automatically.
- 1 In standby mode, press **TIMER/SLEEP** on the remote control for more than two seconds.
- 2 Press **SOURCE** repeatedly to select the sound source.  
→ "SET TIME" and "SELECT SOURCE" are displayed.
- 3 Press **TIMER/SLEEP** to confirm your desired mode.  
→ "SET ON TIME" is displayed and the clock digits for the hours flash.
- 4 Adjust **VOLUME +/-** (or press **VOL +/-** on the remote control) to set the hours.
- 5 Press **TIMER/SLEEP** again.  
→ The clock digits for the minutes flash.
- 6 Adjust **VOLUME +/-** (or press **VOL +/-** on the remote control) to set the minutes.
- 7 Press **TIMER/SLEEP** to confirm the time.  
→ The timer is now set and activated.

### Activating and deactivating timer

- In standby or during playback, press **TIMER/SLEEP** once on the remote control.  
→ Display shows  if activated, and disappears if deactivated.

## Sleep timer setting

The sleep timer enables the system to switch off by itself after a set period of time.

- 1 Press **TIMER/SLEEP** on the remote control repeatedly to select a preset time.  
→ The selections are as follows (time in minutes):  
**60 → 45 → 30 → 15 → 0 → 60 ...**  
→ "SLEEP xx" is displayed. "xx" is the time in minutes.  
→  is displayed if the sleep time you have selected is not 0.
- 2 When you reach the desired length of time, stop pressing the **TIMER/SLEEP** button.

### To deactivate the sleep timer

- Press **TIMER/SLEEP** repeatedly until **0** is displayed, or press **Eco Power/STANDBY-IN** .

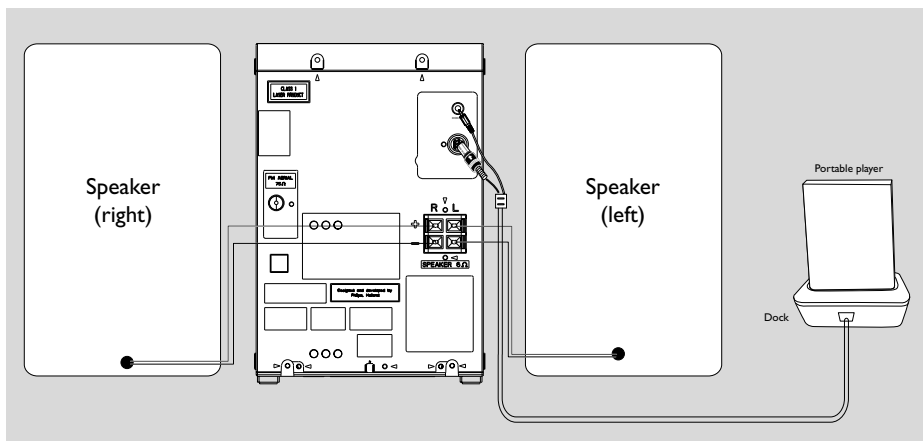

## Playing iPod using the dock

By connecting the supplied dock to your Hi-Fi system, you can listen to the sound of the docked player through the powerful speakers of the Hi-Fi system.

### Compatible iPod player

- Most Apple iPod models with 30-pin dock connector as follows:  
20GB, 40GB, 20/30GB photo, 40/60GB photo, 30GB video, 60GB video, 80GB video, Mini, Nano and Nano 2nd generation.

### Dock adaptor

Before plugging your player in the dock, snap the suitable dock adaptor into the dock to provide a snug fit for the player to be docked.

### Selecting the correct dock adaptor

- 8 dock adaptors of different type, as indicated at the back of the adaptor; are included to fit the following iPod:  
**20GB, 40GB, 20/30GB photo, 40/60GB photo, 30GB video, 60GB video, 80GB video, Mini, Nano and Nano 2nd generation.**

### Installing the dock adaptor

- Align two holes of the dock and two latches of the adaptor; then gently push in the adaptor until it clicks.

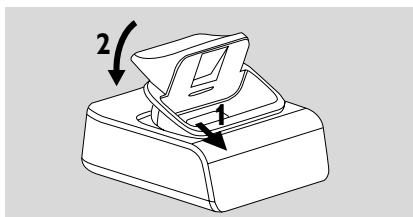

### Removing the dock adaptor

- Slightly push down the dock adaptor; as indicated in the figure below, to un-latch the adaptor; then take it out.

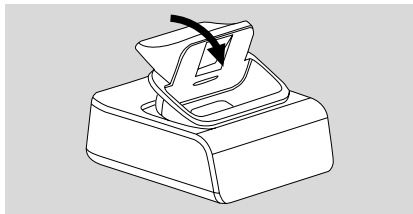

## Playing iPod

- 1 Select the dock adaptor of the correct type, and snap it into the dock (See "**Dock adaptor**").
  - 2 Correctly place your iPod in the dock.
  - 3 Connect the cables of the dock to DOCK IN jacks on the main set correspondingly.
  - 4 Press **SOURCE** repeatedly or **iPod** to select iPod source.
- The connected player will play automatically.

### Notes:

- By using the buttons (▶||, ◀◀, ▶▶ and **VOLUME**) on the MCM398D and its remote control, the following iPod playback features are available: Play/Pause, selecting next/previous track, fast forwarding/rewinding and changing volume.
- The buttons (▲/▼, **OK** and **DISPLAY/MENU**) on the MCM398D and its remote control can work only with playback of the audio contents stored on the docked player.
- Stop (■) function of disc playback is not available to the docked player.

---

## Charging iPod battery using the dock

Docking your iPod and connecting the dock to MCM398D, you can charge the iPod in the standby mode and power-on mode of MCM398D.

### Notes:

- In Eco power standby mode, iPod cannot be charged.
- When the set is switched to the dock mode, if no player is plugged in for 15 minutes, the set will switch to the standby mode.

## AMPLIFIER

Output power .....  
 ..... 2 x 50 W RMS / 2 x 100 W music power  
 Signal-to-noise ratio .....  $\geq 62$  dBA (IEC)  
 Frequency response ..... 40 – 15000 Hz,  $\pm 3$  dB  
 Impedance loudspeakers ..... 6  $\Omega$   
 Impedance headphones ..... 32  $\Omega$

## CD/MP3/WMA-CD PLAYER

Number of programmable tracks ..... 20  
 Frequency range ..... 20 – 20000 Hz  
 Signal-to-noise ratio ..... 75 dBA  
 Channel separation .....  $\geq 60$  dB (1 kHz)  
 Total harmonic distortion .....  $< 0.003\%$   
 MPEG 1 Layer 3 (MP3-CD) ..... MPEG AUDIO  
 MP3-CD bit rate ..... 32-256 kbps  
 (128 kbps advised)  
 Sampling frequencies ..... 32, 44.1, 48 kHz

## USB PLAYER

USB ..... 12 Mb/s, V1.1  
 ..... support MP3 and WMA files  
 Number of albums/folders ..... maximum 99  
 Number of tracks/titles ..... maximum 500

## FM

FM wave range ..... 87.5 – 108 MHz  
 Sensitivity at 75  $\Omega$   
 – mono, 26 dB signal-to-noise ratio ..... 2.8  $\mu$ V  
 – stereo, 46 dB signal-to-noise ratio ..... 61.4  $\mu$ V  
 Selectivity .....  $\geq 28$  dB  
 Total harmonic distortion .....  $\leq 5\%$   
 Frequency response ..... 63 – 12500 Hz ( $\pm 3$  dB)  
 Signal-to-noise-ratio .....  $\geq 50$  dBA

## SPEAKERS

2-way Bass reflex system  
 Dimensions (w x h x d) . 140 x 228 x 247 (mm)

## GENERAL INFORMATION

AC Power ..... 220 – 230 V / 50 Hz  
 Dimensions (w x h x d) .. 152 x 228 x 273 (mm)  
 Weight (with/without speakers)  
 ..... approx. 6.2/3.65 kg  
 Eco Power Standby .....  $< 1$  W  
 Power consumption Standby .....  $< 12$  W

**Specifications and external appearance are subject to change without notice.**

# Maintenance

## Cleaning the Cabinet

- Use a soft cloth slightly moistened with a mild detergent solution. Do not use a solution containing alcohol, spirits, ammonia or abrasives.

## Cleaning Discs

- When a disc becomes dirty, clean it with a cleaning cloth. Wipe the disc from the centre out.
- Do not use solvents such as benzene, thinner, commercially available cleaners, or antistatic spray intended for analogue records.



## Cleaning the disc lens

- After prolonged use, dirt or dust may accumulate at the disc lens. To ensure good playback quality, clean the disc lens with Philips CD Lens Cleaner or any commercially available cleaner. Follow the instructions supplied with cleaner.

# Troubleshooting

## WARNING

**Under no circumstances should you try to repair the system yourself, as this will invalidate the warranty. Do not open the system as there is a risk of electric shock.**

**If a fault occurs, first check the points listed below before taking the system for repair. If you are unable to remedy a problem by following these hints, consult your dealer or Philips for help.**

Problem	Solution
<b>"NO DISC" is displayed.</b>	<ul style="list-style-type: none"><li>✓ Insert a disc.</li><li>✓ Check if the disc is inserted upside down.</li><li>✓ Wait until the moisture condensation at the lens has cleared.</li><li>✓ Replace or clean the disc, see "Maintenance".</li><li>✓ Use a finalised CD-RW or CD-R.</li></ul>
<b>Radio reception is poor.</b>	<ul style="list-style-type: none"><li>✓ If the signal is too weak, adjust the antenna or connect an external antenna for better reception.</li><li>✓ Increase the distance between the Micro HiFi System and your TV or VCR.</li></ul>

Problem	Solution
<b>The system does not react when buttons are pressed.</b>	<ul style="list-style-type: none"> <li>✓ Remove and reconnect the AC power plug and switch on the system again.</li> </ul>
<b>Sound cannot be heard or is of poor quality.</b>	<ul style="list-style-type: none"> <li>✓ Adjust the volume.</li> <li>✓ Disconnect the headphones.</li> <li>✓ Check that the speakers are connected correctly.</li> <li>✓ Check if the stripped speaker wire is clamped.</li> <li>✓ Make sure the MP3-CD was recorded within 32-256 kbps bit rate with sampling frequencies at 48 kHz, 44.1 kHz or 32 kHz.</li> </ul>
<b>The left and right sound outputs are reversed.</b>	<ul style="list-style-type: none"> <li>✓ Check the speaker connections and location.</li> </ul>
<b>The remote control does not function properly.</b>	<ul style="list-style-type: none"> <li>✓ Select the source (CD or FM, for example) before pressing the function button (▶  , ◀◀, ▶▶).</li> <li>✓ Reduce the distance between the remote control and the system.</li> <li>✓ Insert the batteries with their polarities (+/- signs) aligned as indicated.</li> <li>✓ Replace the batteries.</li> <li>✓ Point the remote control directly toward IR sensor on the front of the system.</li> </ul>
<b>The timer is not working.</b>	<ul style="list-style-type: none"> <li>✓ Set the clock correctly.</li> <li>✓ Press TIMER to switch on the timer.</li> </ul>
<b>The Clock/Timer setting is erased.</b>	<ul style="list-style-type: none"> <li>✓ Power has been interrupted or the AC power cable has been disconnected. Reset the clock/timer.</li> </ul>
<b>Some files on the USB device are not displayed.</b>	<ul style="list-style-type: none"> <li>✓ Check if the number of folders exceeds 99 or the number of titles exceeds 500.</li> </ul>
<b>"DEVICE NOT SUPPORTED" scrolls on the display.</b>	<ul style="list-style-type: none"> <li>✓ Remove the USB mass storage device or select another source.</li> </ul>

Meet Philips at the Internet  
<http://www.philips.com>

English

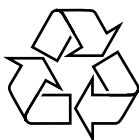

MCM398D



Printed in China

PDCC-ZC-0719