

Micro Hi-Fi System

MCM239

Register your product and get support at

www.philips.com/welcome

User manual

Manual do usuário

Manual del usuario



PHILIPS

México



Es necesario que lea cuidadosamente su instructivo de manejo.

	PRECAUCIÓN - ADVERTENCIA	
	No abrir, riesgo de choque eléctrico	
	ATENCIÓN	
	Verifique que el voltaje de alimentación sea el requerido para su aparato	
Para evitar el riesgo de choque eléctrico, no quite la tapa. En caso de requerir servicio, dirijase al personal calificado.		

Descripción: **Minisistema de Audio**
Modelo : **MCM239/ 55**
Alimentación: **100 – 240V~; 50 – 60 Hz**
Consumo: **15 W**
Importador: **Philips Mexicana, S.A. de C.V.**
Domicilio: **Av. La Palma No.6**
Col. San Fernando La Herradura
Huixquilucan
Localidad y Tel: **Edo. de México C.P. 52784**
Tel.52 69 90 00
Exportador: **Philips Electronics HK, Ltd.**
País de Origen: **China**
N° de Serie: _____

**LEA CUIDADOSAMENTE ESTE INSTRUCTIVO
ANTES DE USAR SU APARATO.**

AVISO IMPORTANTE

Philips Mexicana, S.A. de C.V. no se hace responsable por daños o desperfectos causados por:

- Maltrato, descuido o mal uso, presencia de insectos o roedores (cucarachas, ratones etc.).*
- Cuando el aparato no haya sido operado de acuerdo con el instructivo del uso, fuera de los valores nominales y tolerancias de las tensiones (voltaje), frecuencia (ciclaje) de alimentación eléctrica y las características que deben reunir las instalaciones auxiliares.*
- Por fenómenos naturales tales como: temblores, inundaciones, incendios, descargas eléctricas, rayos etc. o delitos causados por terceros (choques asaltos, riñas, etc.).*

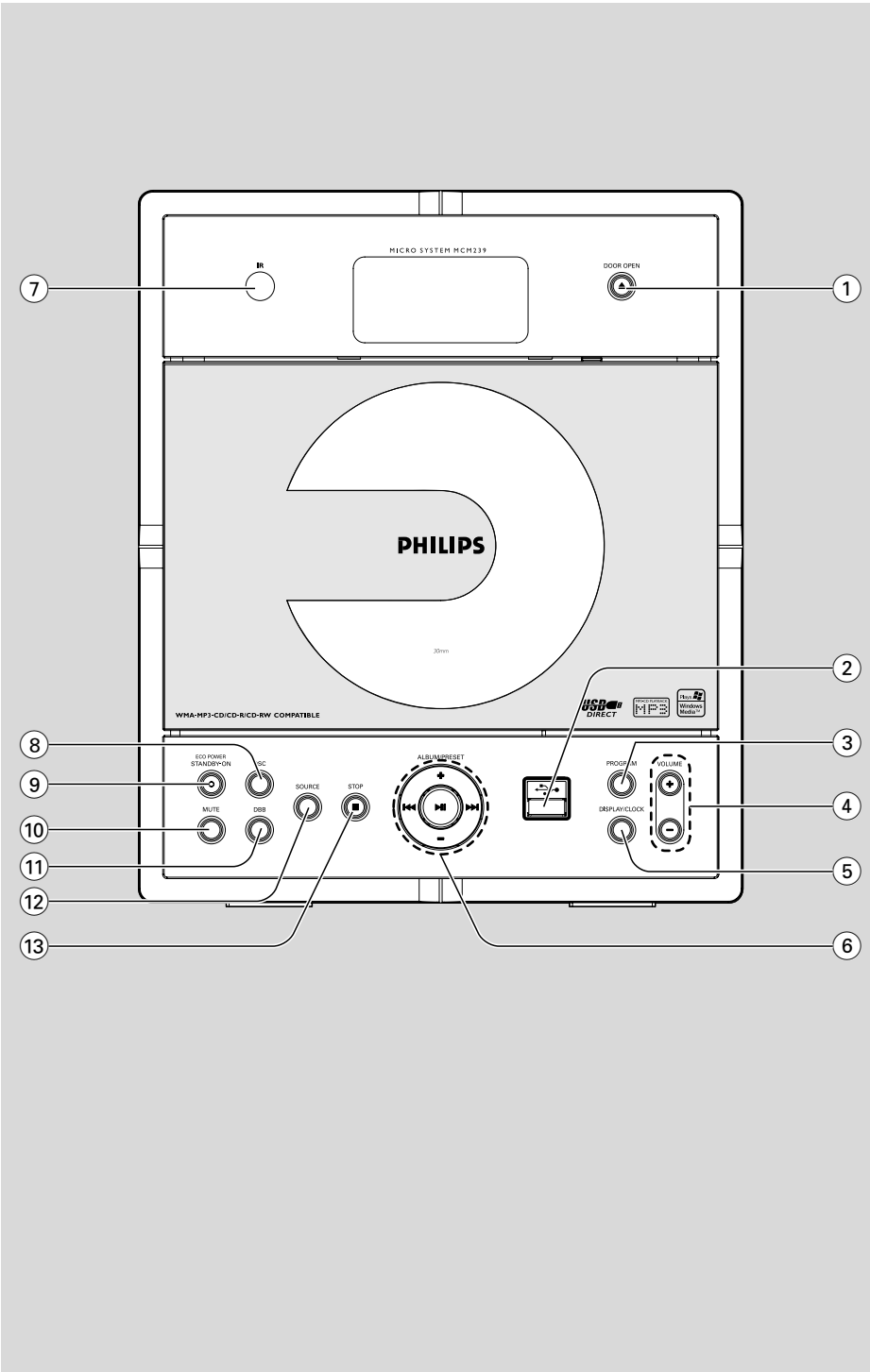

CAUTION

Use of controls or adjustments or performance of procedures other than herein may result in hazardous radiation exposure or other unsafe operation.

ATENCIÓN

El uso de mando o ajustes o la ejecución de métodos que no sean los aquí descritos puede ocasionar peligro de exposición a radiación.

CUIDADO

A utilização de comandos ou ajustes ou a execução de procedimentos diferentes dos descritos neste manual podem provocar uma exposição a radiações perigosas ou outras operações inseguras.

Index

English 6

Español 28

Português 52

English

Español

Português

Contents

General Information

Supplied accessories	7
Environmental information	7
Safety information	8

Controls

Controls on the set	9
Remote control	10-11

Installation

Placing MCM239	11
Mounting stand onto the set	
Rear connections	12-13
Speaker connections	
Antenna connections	
Connecting an additional appliance	13-14
Connecting a USB device	
Connecting a non-USB device	
Using AC power	14

Preparations

Using the remote control	15
Setting the clock	15

Basic Functions

Switching on/off the set and selecting functions	16
Auto-standby	16
Volume control	16
Volume adjustment	
MUTE	
Sound control	16
DSC	
DBB	
Displaying the clock	16

CD

Discs for playback	17
Playing discs	17
Selecting and searching	18
Selecting a different track	
Finding a passage within a track during playback	
Programming tracks	18
Reviewing the program	
Erasing the program	
Different play modes: REPEAT, SHUFFLE	19
Display track information (MP3/WMA only)	19

Tuner

Tuning to radio stations	20
Programming radio stations	20
Autostore:Automatic programming	
Manual programming	
To listen to a preset station	
Changing tuning grid	20

USB

Using a USB mass storage device	21-22
Playing a USB mass storage device	

AUX

AUX (Listening to an external source)	22
---	----

Timer

Setting the timer	23
Activating and deactivating TIMER	23

SLEEP

.....	23
-------	----

Specifications	24
----------------------	----

Maintenance	24
-------------------	----

Troubleshooting	25-26
-----------------------	-------

Congratulations on your purchase and welcome to Philips!

To fully benefit from the support that Philips offers, register your product at www.philips.com/welcome.

Supplied accessories

- 1 X certified power adapter
(Brand name: PHILIPS,
Model No.: AS180-150 AF
Input: 100-240V ~50/60Hz 0.7A,
Output: 15V --- 1.2A)
- 2 speaker boxes including 2 speaker cables
- remote control (with 1 x CR2025 battery)
- MW loop antenna
- FM wire antenna
- stand

Environmental Information

All unnecessary packaging has been omitted. We have tried to make the packaging easy to separate into three materials: cardboard (box), polystyrene foam (buffer) and polyethylene (bags, protective foam sheet).

Your system consists of materials which can be recycled and reused if disassembled by a specialized company. Please observe the local regulations regarding the disposal of packaging materials, exhausted batteries and old equipment.

Safety Information

- Place the system on a flat, hard and stable surface.
- Where the MAINS plug or an appliance coupler is used as the disconnct device, the disconnct device shall remain readily operable.
- Install the unit near the AC outlet and where the AC power plug can be easily reached.
- The apparatus shall not be exposed to dripping or splashing.
- Place the system in a location with adequate ventilation to prevent internal heat build-up in your system. Allow at least 10 cm (4 inches) clearance from the rear and the top of the unit and 5 cm (2 inches) from each side.
- The ventilation should not be impeded by covering the ventilation openings with items, such as newspapers, table-cloths, curtains, etc.
- Do not expose the system, batteries or discs to excessive moisture, rain, sand or heat sources caused by heating equipment or direct sunlight.
- No naked flame sources, such as lighted candles, should be placed on the apparatus.
- No objects filled with liquids, such as vases, shall be placed on the apparatus.
- If the system is brought directly from a cold to a warm location, or is placed in a very damp room, moisture may condense on the lens of the disc unit inside the system. Should this occur, the CD player would not operate normally. Leave the power on for about one hour with no disc in the system until normal playback is possible.
- The mechanical parts of the set contain self-lubricating bearings and must not be oiled or lubricated.
- Batteries (battery pack or batteries installed) shall not be exposed to excessive heat such as sunshine, fire or the like.
- **When the system is switched to Standby mode, it is still consuming some power. To disconnect the system from the power supply completely, remove the AC power plug from the wall socket.**

General Information

Hearing Safety

Listen at a moderate volume.

- Using headphones at a high volume can impair your hearing. This product can produce sounds in decibel ranges that may cause hearing loss for a normal person, even for exposure less than a minute. The higher decibel ranges are offered for those that may have already experienced some hearing loss.
- Sound can be deceiving. Over time your hearing "comfort level" adapts to higher volumes of sound. So after prolonged listening, what sounds "normal" can actually be loud and harmful to your hearing. To guard against this, set your volume to a safe level before your hearing adapts and leave it there.

To establish a safe volume level:

- Set your volume control at a low setting.
- Slowly increase the sound until you can hear it comfortably and clearly, without distortion.



Listen for reasonable periods of time:

- Prolonged exposure to sound, even at normally "safe" levels, can also cause hearing loss.
- Be sure to use your equipment reasonably and take appropriate breaks.

Be sure to observe the following guidelines when using your headphones.

- Listen at reasonable volumes for reasonable periods of time.
- Be careful not to adjust the volume as your hearing adapts.
- Do not turn up the volume so high that you can't hear what's around you.
- You should use caution or temporarily discontinue use in potentially hazardous situations.
- Do not use headphones while operating a motorized vehicle, cycling, skateboarding, etc.; it may create a traffic hazard and is illegal in many areas.

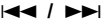
Controls on the set (illustrations on page 3)

- ① **DOOR OPEN**
 - press to open the CD door:
- ② 
 - jack for the external USB mass storage device
- ③ **PROGRAM**
 - **CD/USB:** programs tracks
 - **Tuner:** programs preset radio stations
- ④ **VOLUME**
 - adjusts the volume level
 - **Clock/Timer:** adjusts the hours and minutes
- ⑤ **DISPLAY/CLOCK**
 - **Clock:**
 - displays the set time
 - **In standby mode:** enters the clock setting mode (press and hold for more than 2 seconds)
 - **TUNER/Audio CD/AUX:** switches between clock display and playback display
 - **MP3/WMA files:** displays disc information during playback
- ⑥ **ALBUM/ PRESET + /-**
 - **CD/USB:** selects albums (for MP3/WMA only)
 - **TUNER:** selects a preset radio station
 - 
 - **CD/USB:** skips or searches CD tracks backwards/forwards
 - **Tuner:** tunes to radio stations
 - 
 - **CD/USB:** starts or pauses playback
- ⑦ **IR**
 - sensor for the infrared remote control
 - **Helpful hints:** Always point the remote control towards this sensor.
- ⑧ **DSC (Digital Sound Control)**
 - selects predefined sound settings: **ROCK, JAZZ, POP, CLASSIC, OPTIMAL**
- ⑨ **STANDBY-ON**
 - press briefly to switch the set on or off (standby)
- ⑩ **MUTE**
 - switches the sound off temporarily
- ⑪ **DBB (Dynamic Bass Boost)**
 - turns the bass enhancement on/off
- ⑫ **SOURCE**
 - selects sound source **CD, USB, TUNER,** or **AUX**
 - **In standby or Eco Power mode:** switches the set on and selects sound source **CD, USB, TUNER** or **AUX**
- ⑬ **STOP**
 - **CD/USB:** stops playback; erase a program.
 - **Tuner:** press and hold to change tuning grid between 10 kHz and 9 kHz.

Remote control

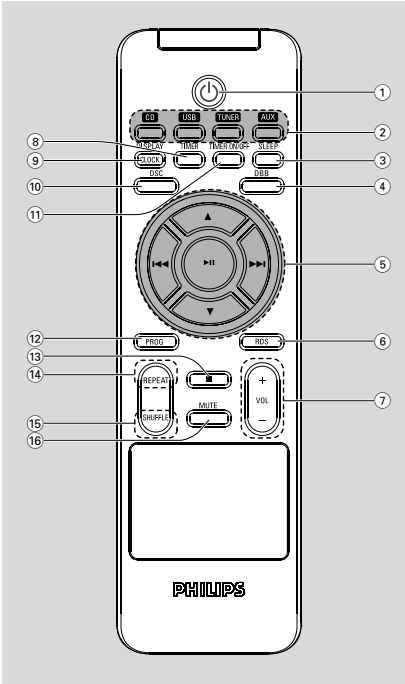

Notes for remote control:

- First select the source you wish to control by pressing one of the source select keys on the remote control (for example CD, TUNER).
- Then select the desired function (for example **▶ II**, **◀ II**).

- ① **⏻**
 - press briefly to switch the set on or off (standby)
- ② **Source buttons**

USB

 - selects **USB** source
 - **In standby mode:** switches the set on and selects **USB** source.

CD

 - selects **CD** source
 - **In standby mode:** switches the set on and selects **CD** source.

TUNER

- selects **TUNER** source and toggles between the wavebands: FM and MW
- **In standby mode:** switches the set on and selects **TUNER** source

AUX

- selects the audio input from an additional connected appliance
- **In standby mode:** switches the set on and selects the audio input from an additional connected appliance

- ③ **SLEEP**
 - set the sleep timer
- ④ **DBB (Dynamic Bass Boost)**
 - turns the bass enhancement on/off
- ⑤ **◀◀ / ▶▶**
 - **CD/USB:** skips or searches CD tracks backwards/forwards
 - **Tuner:** tunes to radio stations
 - **▲ / ▼**
 - **CD/USB:** selects the next/previous album (for MP3/WMA only)
 - **TUNER:** selects a preset radio station
 - **▶ II**
 - **CD/USB:** starts or pauses playback
- ⑥ **RDS (No function on this version)**
- ⑦ **VOL + / –**
 - adjusts the volume level

- **Clock/Timer:** adjusts the hours and minutes
- ⑧ **TIMER**
 - enters the timer setting mode (press and hold for more than 2 seconds)
- ⑨ **DISPLAY/CLOCK**
 - **Clock:** - displays the set time
 - **In standby mode:** enters the clock setting mode (press and hold for more than 2 seconds)
 - **TUNER/Audio CD/AUX:** switches between clock display and playback display
 - **MP3/WMA files:** displays disc information during playback

- ⑩ **DSC (Digital Sound Control)**
 - selects predefined sound settings: **ROCK**, **JAZZ**, **POP**, **CLASSIC**, **OPTIMAL**
- ⑪ **TIMER ON/OFF**
 - switches the timer on/off
- ⑫ **PROG**
 - **CD/USB**: programs tracks
 - **Tuner**: programs preset radio stations
- ⑬ **■**
 - **CD/USB**: stops playback; erase a program
- ⑭ **REPEAT**
 - selects continuous playback
- ⑮ **SHUFFLE**
 - selects random playback
- ⑯ **MUTE**
 - switches the sound off temporarily

Placing MCM239

MCM239 is supplied with a stand, you may attach or detach the stand to/from the main set.

Mounting the stand onto the set

- ① Locate the bottom of the main unit and find the slot, then slide the stand in the slot until it stops, as indicated in the figure below.

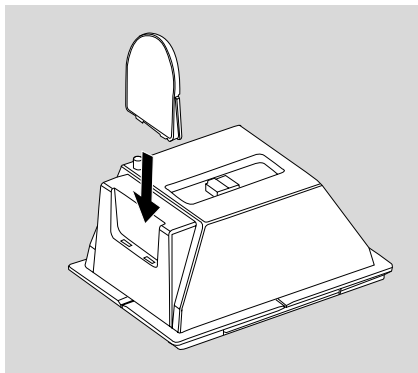

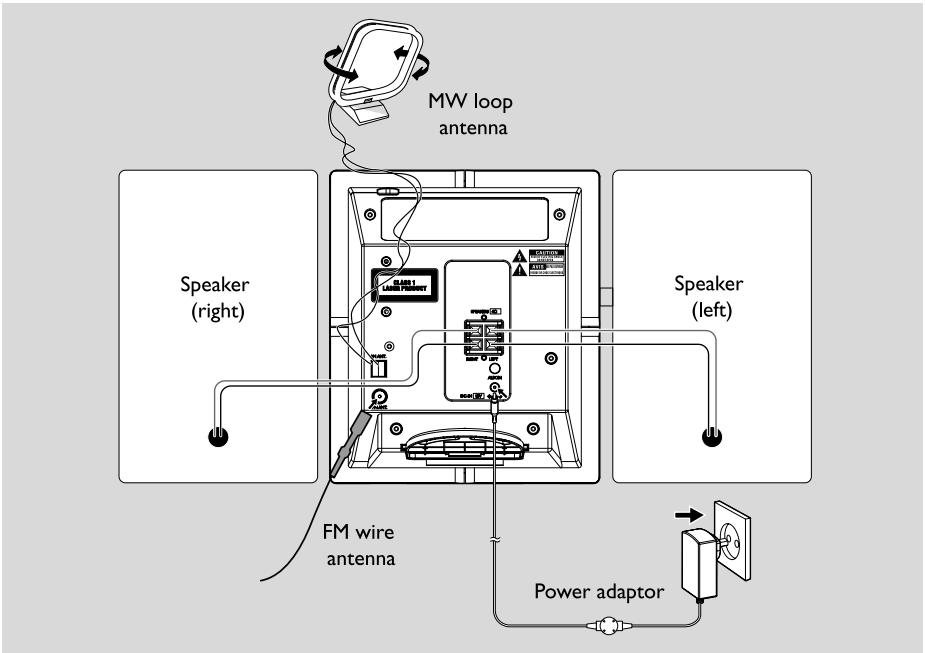

Rear connections

Warning:

- **Never make or change connections with the mains supply switched on.**
- **Install your set near the AC outlet and where the AC power plug can be reached easily.**

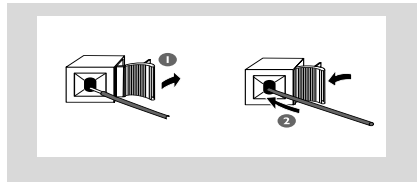

(A) Speaker connections

Use the supplied speakers only. Using other speakers can damage the set or the sound quality will be negatively affected.

- Connect the cable of the left speaker to **LEFT** (red and black) and the cable of the right speaker to **RIGHT** (red and black) as follows:
 - Press the clip of the red terminal and fully insert the stripped portion of the colored (or marked) speaker cable into the socket, then release the clip
 - Press the clip of the black terminal and fully insert the stripped portion of the black (or unmarked) speaker cable into the socket, then release the clip

(B) Antenna connections

MW antenna

Connect the supplied MW loop antenna to the "AM aerial" terminal. Adjust the position of the antenna for optimal reception.

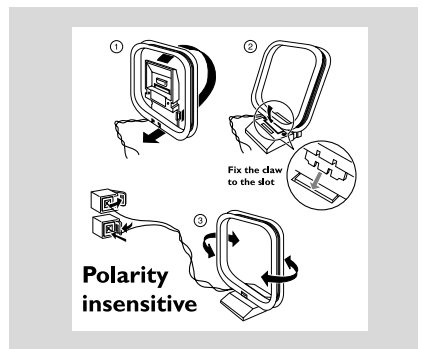

- Position the antenna as far as possible from a TV, VCR or other radiation source.

FM antenna

The wire antenna supplied can only be used to receive nearby stations. For better reception we recommend using a cable antenna system or an outdoor antenna.

- 1 Extend the wire antenna and fit it to FM ANTENNA as shown below.

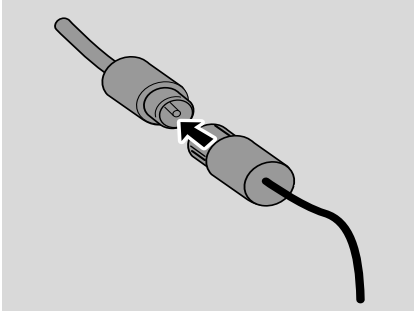

Note: If you are using a cable antenna system or an outdoor antenna, fit the antenna plug, instead of the wire antenna, to FM ANTENNA .

- 2 Move the antenna in different positions for optimal reception (as far away as possible from the TV, VCR or other radiation sources)
- 3 Fix the antenna's end to the wall.

Helpful hints:

– To receive optimal radio reception, put the main unit and the antennas as far away as possible from the power adaptor.

Connecting an additional appliance

Connecting a USB device or memory card

By connecting a USB mass storage device (including USB flash memory, USB flash players or memory cards) to the Hi-Fi system, you can enjoy the music stored on the external device through the powerful speakers of Hi-Fi system.

- 1 Insert the USB device's USB plug into the socket  on the front panel of the main set.

Or,

for the devices with USB cable:

- a. Insert one plug of the USB cable (not supplied) to the socket  on the front panel of the main set.
- b. Insert the other plug of the USB cable to the USB output terminal of the USB device.

Or,

for the memory card:

- a. Insert the memory card into a card reader (not supplied).
- b. Use a USB cable (not supplied) to connect the card reader to the socket  on the front panel of the main set.

Connecting a non-USB device

It is possible to use an additional appliance, e.g. TV, VCR or CD recorder with the set. On MCM239, you can playback music from an external source.

- 1 Insert one plug of the audio cable (not supplied) to the socket **AUX IN** at the rear panel of the main set.
- 2 Connect the other end of the audio cable to the **AUDIO OUT** terminal of the additional appliance.
- 3 Select **AUX** mode on the set.

Helpful hints:

– Always refer to the owner's manual of other equipment for complete connection.

Installation

Using AC power

- 1 Make sure all the connections have been made before switching on the power supply.
- 2 Connect the supplied AC/DC power adaptor to the DC jack (located on the rear panel of the main set) and to the wall socket. This switches on the power supply.

To avoid damage to the set, use only the adaptor supplied.

When MCM239 is switched to standby, it is still consuming some power: **To disconnect the system from the power supply completely, remove the power plug from the wall socket.**

The type plate is located on the rear of the set.

Warning!

To avoid overheating of the system, a safety circuit has been built in. Therefore, your system may switch to Standby mode automatically under extreme conditions. If this happens, let the system cool down before reusing it (not available for all versions). This product complies with the radio interference requirements of the European Community.

CAUTION

Visible and invisible laser radiation. If the cover is open, do not look at the beam.

High voltage! Do not open. You run the risk of getting an electric shock.

The machine does not contain any user-serviceable parts.

Modification of the product could result in hazardous radiation of EMC or other unsafe operation.

Using the remote control

IMPORTANT!

- Remove the **protective plastic tab** before using the remote control.
- Always point the remote control directly towards IR area on the Center or Station you wish to operate.

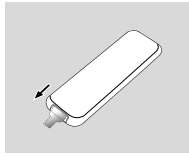

Notes for remote control:

- First select the source you wish to control by pressing one of the source select keys on the remote control (for example **CD, TUNER**).
- Then select the desired function (for example **▶ II, ◀ I, ▶ I**).

To replace the remote controls' battery

- 1 Push to open the battery tray.
- 2 Replace a new battery according to the indicated polarity.
- 3 Push the battery tray back to close it.

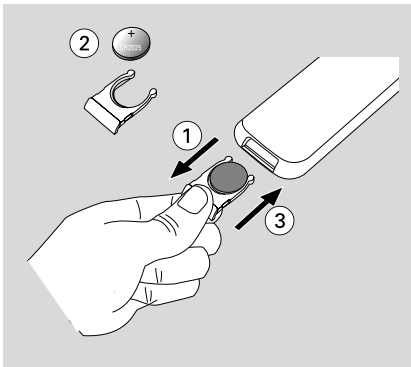

CAUTION!

- Remove the battery if it is exhausted or will not be used for a long time.
- Batteries contain chemical substances, so they should be disposed of properly.

Setting the clock

After connecting MCM239 to the power supply, set the clock first.

- 1 Press and hold **STANDBY-ON** to switch the set to Standby mode.
 - The display shows the set time.
 - -- --:-- -- flashes by default if you have not set the clock.
- 2 In the standby mode, press and hold **DISPLAY/CLOCK**.
 - **SET CLOCK** scrolls on the display
 - **24 HR** or **12 HR** appears for the initial clock setting. **To select 24-hour clock or 12-hour clock,**
 - a. Press **VOLUME +/-**.
 - b. Press **DISPLAY/CLOCK** to confirm
 - The hours digits start flashing
- 3 Hold down or press **VOLUME +/-** repeatedly to set the hours.
- 4 Press **DISPLAY/CLOCK** to confirm
 - The minutes digits start flashing
- 5 Hold down or press **VOLUME +/-** repeatedly to set the minutes.
- 6 Press **DISPLAY/CLOCK** to confirm
 - To exit without storing the clock setting press **STOP** ■

Helpful hints:

- The clock setting will be erased when the system is disconnected from the power supply.
- The set will exit from the clock setting mode if no button is pressed within 90 seconds.

Basic Functions

Switching on/off the set and selecting functions

- 1 To switch on, press **STANDBY-ON** or **SOURCE** on the set (or \odot on the remote control).
→ The set switches to the last source selected.
- OR**
On the remote control, press the source button (e.g. **USB, CD, TUNER, AUX**).
- 2 When the set is on, press **STANDBY-ON** to switch off (or \odot on the remote control).
- 3 To select your function, press **SOURCE** once or more on the set (or **USB, CD, TUNER, AUX** on the remote control).

To switch the system to standby mode

- Press **STANDBY-ON** \odot (or \odot on the remote).

Helpful hints:

– In the standby mode, the tone, sound settings, tuner presets and the volume level (up to a maximum volume level of 12) will be retained in the set's memory.

Auto-standby

When the set has reached the end of CD playback and remains in the stop position for more than 15 minutes, the set will switch off automatically to save power.

Volume control

Volume adjustment

- Adjust the volume by pressing **VOLUME +/-**.
→ **VOL** and the actual value (between 1 and 31) are displayed.
→ **VOL MIN** is the minimum volume level.
→ **VOL MAX** is the maximum volume level.

MUTE

You can temporarily switch off the sound without switching off the set.

- 1 Press **MUTE** to switch off the sound.
→ **MUTE** appears. Playback continues without sound.
- 2 To switch on the sound, you can:
 - press **MUTE** again;
 - adjust the volume controls;
 - change source.

Sound control

DSC

Digital Sound Control enables you to select predefined sound settings.

- Press **DSC** repeatedly to select the desired sound setting: **ROCK, JAZZ, POP, CLASSIC, OPTIMAL**.

DBB

- Press **DBB (Dynamic Bass Boost)** once or more to switch bass enhancement on or off.
→ **DBB** appears if **DBB** is activated.

Displaying the clock

- During playback, press **DISPLAY/CLOCK** on the remote control repeatedly to switch between the clock display and the playback display.

Note:

– When playing MP3 files, you will get track information

Discs for playback

With this system, you can play

- all pre-recorded audio CDs (CDDA)
- all finalized audio CD-Rs and CD-RWs
- MP3/WMA-CDs (CD-Rs/CD-RWs with MP3/WMA files)



IMPORTANT!

– **This system is designed for regular discs. Therefore, do not use any accessories such as disc stabilizer rings or disc treatment sheets, etc.**

About MP3/WMA

The music compression technology MP3 (MPEG1 Audio Layer 3) and WMA (Windows Media Audio) significantly reduces the digital data of an audio CD while maintaining CD quality sound.

Windows Media Audio® is a registered trademark of Microsoft Corporation.

Supported formats:

- Disc format ISO9660, Joliet, UDF (created on Adaptec Direct CD) and multi-session CDs
- MP3 bit rate (data rate): 32-320 Kbps and variable bit rate
- Directory nesting up to a maximum of 8 levels
- Max. track number plus album: 500
- WMA v9 or earlier



The system will not play or support the following:

- Empty albums: an empty album is an album that does not contain MP3/WMA files, and will not be shown in the display.
- Non-supported file formats are skipped. This means that e.g.: Word documents .doc or MP3 files with extension .dlf are ignored and will not be played.
- DRM protected WMA files
- WMA files in Lossless or VBR format

IMPORTANT!

- Make sure that the file names of MP3 files end with .mp3.
- For DRM protected WMA files, use Windows Media Player 10 (or later) for CD burning/ conversion. Visit www.microsoft.com for details about Windows Media Player and WM DRM (Windows Media Digital Rights Management).

Playing discs

- 1 Press **SOURCE** once or more to select **CD** (or **CD** on the remote control)
→ The CD icon  appears
- 2 Press **DOOR OPEN** to open the CD door:
→  OPEN is displayed.
- 3 Insert a disc with the printed side facing up. Then close the CD door:
→ **READING** is displayed as the CD player scans the contents of a disc
→ **Audio CD:** the total number of tracks and playing time are shown
MP3/WMA: Display shows current album number "A x x" and current track number "T x xx".

Helpful hints:

– If you have not organized MP3/WMA files into any albums on your disc, an album "00" will be automatically assigned for all those files.

- 4 Press **▶ ||** to start playback.
→ Display shows current track number and elapsed playing time.
- 5 To pause playback, press **▶ ||**. To resume playback, press the button again.
- 6 To stop playback, press **STOP ■**

Helpful hints:

CD play will also stop when

- the CD door is opened.
- the disc has reached the end.
- you select another source: **TUNER, USB** or **AUX**.

Selecting and searching

Selecting a different track

- Press **I◀◀ / ▶▶I** once or repeatedly until the desired track number appears in the display.
MP3/WMA: → Track information scrolls briefly.
- MP3/WMA:**
- Press **ALBUM/ PRESET** once or more to select the next or previous album.
 → Album information scrolls briefly.
or
- In the stop position, press **ALBUM/ PRESET** and **I◀◀ / ▶▶I** to select the desired album and track.
 → **MP3/WMA:** Display shows current album/ track number.

Finding a passage within a track during playback

- 1 During playback, press and hold **I◀◀ / ▶▶I**
 → The CD plays at a high speed.
- 2 When you recognize the passage you want, release **I◀◀** or **▶▶I**.
 → Normal playback resumes.

Programming tracks

You may store up to 20 tracks in the desired sequence. If you like, store any track more than once.

- 1 In the stop position, press **PROGRAM** to start programming.
 → **PROG** flashes.
- 2 Press **I◀◀ / ▶▶I** once or repeatedly until the desired track number appears in the display.
- **MP3/WMA:** press **ALBUM/ PRESET** and **I◀◀ / ▶▶I** to select the desired album and track.
- 3 Press **PROGRAM** to confirm.
 → Display shows briefly the number of tracks programmed.
 → Then, the display shows the track number you just stored.
- 4 Repeat steps 2-3 to select and store all desired tracks.
 → **FULL** is displayed if you attempt to program more than 20 tracks.
- 5 Press **▶ II** play the program.

Helpful hints:

- The set will return to the stop position if no button is pressed within 90 seconds. To resume programming, press **PROGRAM**.
- **MP3/WMA:** When playing a program, use of **ALBUM/ PRESET** are void.

Erasing the program

You can erase the contents of the memory by:

- Press **■**
 - once if in the stop position;
 - twice during playback;
- Press **STANDBY-ON**.
- Select another sound source.
- Open the CD door.
 → **PROG** disappears.

Different play modes: REPEAT, SHUFFLE

REP TRACK – plays the current track continuously.

REP ALL – plays the entire disc/program continuously.

SHUF – plays all the tracks in random order.

- 1 During playback, press once or more **REPEAT** or **SHUFFLE** to select play modes.
- 2 To return to normal playback, press **REPEAT** or **SHUFFLE** repeatedly until the various modes are no longer displayed.

Helpful hints:

– In the shuffle mode, press **▶▶1** to select tracks.

Display track information (MP3/WMA only)

The ID3 tag is part of an MP3/WMA file and contains various track information such as the track's title or the artist's name.

- During playback, press **DISPLAY/CLOCK** repeatedly on the remote control.
→ Display show title name, album name and ID3 tag information.

Helpful hints:

- Complete the ID3 tag information with your MP3/WMA encoder software before burning the MP3/WMA-CD.

Tuner

Tuning to radio stations

- 1 Press **SOURCE** once or more to select **TUNER** (or **TUNER** on the remote control).
- 2 Press **TUNER** on the remote control repeatedly to select your desired waveband, FM or MW.
 - Display shows: , radio station frequency, waveband and if programmed, a preset number.
- 3 Press and hold **◀◀ / ▶▶** until **SEARCH** appears.
 - The radio automatically tunes to a station with sufficient reception. Display shows **SEARCH** during automatic tuning.
 - **FM**: If a station is received in stereo, **STEREO** is shown.
 - **FM**: When you are receiving an RDS station, **R-D-S** is shown.
- 4 Repeat step 3 if necessary until you find the desired station.
- To tune to a weak station, press **◀◀ / ▶▶** briefly and repeatedly until you have found optimal reception.

Programming radio stations

You can store up to a total of 40 radio stations (FM and MW) in the memory, manually or automatically (Autostore).

Autostore: Automatic programming

Automatic programming will start from preset 1 or a chosen preset number. From this preset number upwards, former programmed tuner stations will be erased. The set will only program stations which are not in the memory already.

- 1 Press the **ALBUM/ PRESET** buttons once or more to select the preset number where programming should start.

Note:

– If no tuner preset number is selected, default is preset 1 and all your presets will be erased.

- 2 Press and hold **PROGRAM** until **AUTO** appears.
 - **PROG** flashes.
 - Available stations are programmed in order of waveband reception strength: FM followed by MW.

→ After all stations are stored, the first preset station will then be played.

Manual programming

- 1 Tune to your desired station (see **Tuning to radio stations**).
- 2 Press **PROGRAM** to activate programming.
 - **PROG** flashes.
- 3 Press **ALBUM/ PRESET** to allocate a number from 1 to 40 to this station.
- 4 Press **PROGRAM** to confirm.
 - Display shows the preset number, waveband and the frequency of the preset station.
- 5 Repeat steps 1-4 to store other stations.
- You can erase a preset station by storing another frequency in its place.

To listen to a preset station

- Press the **ALBUM/ PRESET** buttons once or more until the desired preset station is displayed.

Changing tuning grid

In some countries, the frequency step between adjacent channels is 9 kHz (10 kHz in some areas). The preset frequency step in the factory is 10 kHz.

- 1 Select tuner mode.
- 2 Press and hold **■** for more than 2 seconds .

Note:

– All preset stations will be lost and need to be reprogrammed.

Using a USB mass storage device

By connecting a USB mass storage device to the Hi-Fi system, you can enjoy the music stored on the external device through the powerful speakers of Hi-Fi system.

Playing a USB mass storage device

Compatible USB mass storage devices

With the Hi-Fi system, you can use

- USB flash memory (USB 2.0 or USB1.1)
- USB flash players (USB 2.0 or USB1.1)
- memory cards (requires an additional card reader to work with this Hi-Fi system)

Note:

- In some USB flash players (or memory devices), the stored contents are recorded using copyright protection technology. Such protected contents will be unplayable on any other devices (such as this Hi-Fi system).

Supported formats:

- USB or memory file format FAT12, FAT16, FAT32 (sector size: 512 - 65,536 bytes)
- MP3 bit rate (data rate): 32-320 Kbps and variable bit rate
- WMA v9 or earlier
- Directory nesting up to a maximum of 8 levels
- Number of albums/ folders: maximum 50
- Number of tracks/titles: maximum 500
- ID3 tag v2.0 or later
- File name in Unicode UTF8 (maximum length: 128 bytes)

The system will not play or support the following:

- Empty albums: an empty album is an album that does not contain MP3/WMA files, and will not be shown in the display.
- Non-supported file formats are skipped. This means that e.g.: Word documents .doc or MP3 files with extension .dlf are ignored and will not be played.
- AAC, WAV, PCM audio files
- DRM protected WMA files
- WMA files in Lossless format

How to transfer music files from PC to a USB mass storage device

By dragging and dropping music files, you can easily transfer your favorite music from PC to a USB mass storage device.

For the flash player, you can also use its music management software for the music transfer.

However, those WMA files may be unplayable for compatibility reasons.

How to organize your MP3/WMA files on the USB mass storage device

This Hi-Fi system will browse the MP3/WMA files in the folders/sub-folders/titles order.

Example:

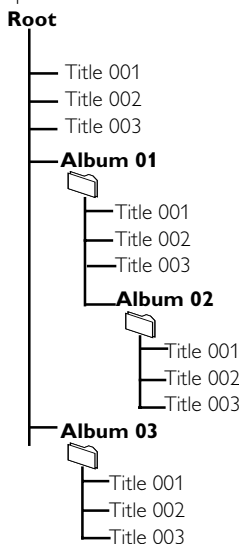

Organize your MP3/WMA files in different folders or subfolders as required.

Note:

- If you have not organized MP3/WMA files into any albums on your disc, an album "00" will be automatically assigned for all those files.
- Make sure that the file names of MP3 files end with .mp3, and the file names of WMA files end with .wma.
- For DRM protected WMA files, use Windows Media Player 10 (or later) for conversion. Visit www.microsoft.com for details about Windows Media Player and WM DRM (Windows Media Digital Rights Management).

USB

- 1 Check the USB device has been properly connected. (See **Installation: Connecting an additional appliance**).
- 2 Press **SOURCE** once or more to select **USB** (or **USB** on the remote control).
 - The icon  appears.
 - **NO AUDIO** appears if no audio file is found in the USB device.
- 3 Play the USB's audio files as you do with the albums/tracks on a CD (See **CD**).

Note:

- For compatibility reasons, the album/track information may differ from what it is displayed through flash players' music management software.
- File names or ID3 tags will be displayed as ---- if they are not in English.

INFORMATION REGARDING USB DIRECT:

1. *Compatibility of the USB connection on this micro system:*

- a) *This micro system supports most USB Mass storage devices (MSD) that these devices are compliant to the USB MSD standards.*
- i) *Most common Mass storage class devices are flash drives, memory sticks, jump drives and etc.*

- ii) *If you see a "Disc Drive" showing up on your computer after you have plugged the mass storage device into your computer, most likely it is MSD compliant and it will work with this micro system.*
 - b) *If your Mass storage device requires a battery/power source, please make sure you have a fresh battery in it or charge the USB device first and then plug it into the micro system again.*
- 2) **Supported Music type:**
- a) *This device only supports unprotected music with file extension: .mp3 .wma*
 - b) *Music bought from on-line music stores are not supported because they are secured by Digital Rights Management protection (DRM).*
 - c) *File name extensions that ended with the following are not supported: .wav; .m4a; .m4p; .mp4; .aac and etc.*
- 3) *No Direct connection can be made from a Computer USB port to the micro system even you have either or both mp3 or wma file in your -computer.*

AUX

AUX (Listening to an external source)



You can listen to the sound of the connected external device through your MCM239.

- 1 Check the external device has been properly connected (See **Installation, Connecting an additional appliance**).
- 2 Press **SOURCE** once or more to select **AUX** (or **AUX** on the remote control).
- 3 To avoid noise distortion, turn down the volume on your external device.

- 4 Press the **PLAY** key on the connected device to start playback.
- 5 To adjust the sound and volume, use the sound controls on your external device and the MCM239.

Setting the timer



The set can be used as an alarm clock, whereby the selected source (CD, TUNER or USB) starts playback at a preset time. **Make sure the clock is set before using the timer.**

- 1 In standby mode, press and hold **TIMER** on the remote control until  appears.
→  flashes. **SELECT SOURCE** displays.
- 2 Press **SOURCE** on the set repeatedly to select the source (or press **CD, TUNER** or **USB** on the remote control).
- 3 Press **TIMER** to confirm.
→ The hours digits start flashing.
- 4 Hold down or press **VOLUME +/-** repeatedly to set the hours.
- 5 Press **TIMER** to confirm.
→ The minutes digits start flashing.
- 6 Hold down or press **VOLUME +/-** repeatedly to set the minutes.
- 7 Press **TIMER** to confirm.
→ The timer is now set and activated.
→ At the set alarm time, the CD, TUNER or USB will switch on (volume level: max. 13).

Note:

– The set will exit from the timer setting mode if no button is pressed within 90 seconds.

Activating and deactivating TIMER

- In standby mode, press and hold **TIMER ON/OFF** on the remote once or more to activate or deactivate the timer.
→ Display shows  if activated, and  disappears if deactivated.

Helpful hints:

The timer will not work at the set time if

- the set is switched on
- the timer is deactivated

The set will switch to Tuner source automatically if :

- no CD is inserted when the selected source is CD;
- no USB device is connected when the selected source is USB.

SLEEP

You can set a certain period of time after which the set will switch off.

- During playback, on the remote control, press **SLEEP** repeatedly to select the desired time period options (in minutes):
→ Display shows in sequence: **Sleep 90, 75, 60, 45, 30, 15.**
→ Display shows the selected option briefly and returns to its previous status. The icon **zzZ** appears.

To deactivate the sleep timer, press **SLEEP** again.

→ The icon **zzZ** disappears.

or

Press **STANDBY-ON** to switch off the set (or  on the remote control).

Helpful hints:

– The SLEEP function does not affect your alarm time setting.

Specifications

AMPLIFIER

Output power 2 x 5 W RMS
Signal-to-noise ratio ≥ 65 dBA
Frequency response 100 – 18kHz, ± 3 dB
Input sensitivity AUX 2 V
Impedance loudspeakers $\geq 4 \Omega$
Impedance headphones 32Ω -1000 Ω
..... <15mW

CD PLAYER

Frequency range 100 – 18kHz
Signal-to-noise ratio 65 dBA

TUNER

FM wave range 87.5 – 108 MHz
MW wave range
1.Tuning grid 10 kHz 530 – 1700 kHz
2.Tuning grid 9 kHz 531 – 1602 kHz
Number of presets 40
Antenna
FM..... 75 Ω wire
MW Loop antenna

USB PLAYER

USB V2.0/V1.1
..... support MP3 and WMA files
Number of albums/ folders maximum 50
Number of tracks/titles maximum 500

SPEAKERS

Bass reflex system
Dimensions (w x h x d) .. 158 x 250x 118 (mm)

GENERAL INFORMATION

AC Power 100 – 240 V, 50 Hz/60Hz
Dimensions (w x h x d, with/without the stand)
..... 211 x 250 x 160/211 x 250 x 126 (mm)
Weight(with/without speakers) 2.9 / 1.23 kg
Standby power consumption <2 W

Specifications and external appearance are subject to change without notice.

Maintenance

Cleaning the Cabinet

- Use a soft cloth slightly moistened with a mild detergent solution. Do not use a solution containing alcohol, spirits, ammonia or abrasives.

Cleaning Discs

- When a disc becomes dirty, clean it with a cleaning cloth. Wipe the disc from the centre out.
- Do not use solvents such as benzene, thinner; commercially available cleaners, or antistatic spray intended for analogue records.



Cleaning the disc lens

- After prolonged use, dirt or dust may accumulate at the disc lens. To ensure good playback quality, clean the disc lens with Philips CD Lens Cleaner or any commercially available cleaner. Follow the instructions supplied with cleaner.

WARNING

Under no circumstances should you try to repair the system yourself, as this will invalidate the warranty. Do not open the system as there is a risk of electric shock.

If a fault occurs, first check the points listed below before taking the system for repair. If you are unable to remedy a problem by following these hints, consult your dealer or Philips for help.

Problem	Solution
"NO DISC" is displayed.	<ul style="list-style-type: none"> ✓ Insert a disc. ✓ Wait until the moisture condensation at the lens has cleared. ✓ Replace or clean the disc, see "Maintenance". ✓ Use a finalised CD-RW or a correct MP3/WMA-CD format disc.
Some files on the USB device are not displayed.	<ul style="list-style-type: none"> ✓ Check if the number of folders exceeds 50 or the number of titles exceeds 500
Radio reception is poor.	<ul style="list-style-type: none"> ✓ If the signal is too weak, adjust the antenna or connect an external antenna for better reception. ✓ Increase the distance between the Micro HiFi System and your TV or VCR.
The system does not react when buttons are pressed.	<ul style="list-style-type: none"> ✓ Remove and reconnect the AC power plug and switch on the system again.
Sound cannot be heard or is of poor quality.	<ul style="list-style-type: none"> ✓ Adjust the volume. ✓ Disconnect the headphones. ✓ Check that the speakers are connected correctly. ✓ Check if the stripped speaker wire is clamped. ✓ Make sure the MP3-CD was recorded within 32~256 kbps bit rate with sampling frequencies at 48 kHz, 44.1 kHz or 32 kHz.
The left and right sound outputs are reversed.	<ul style="list-style-type: none"> ✓ Check the speaker connections and location.

Troubleshooting

The remote control does not function properly.

- ✓ Select the source (CD or TUNER, for example) before pressing the function button (▶||, ◀, ▶|).
- ✓ Reduce the distance between the remote control and the system.
- ✓ Insert the battery with its polarities (+/- signs) aligned as indicated.
- ✓ Replace the battery.
- ✓ Point the remote control directly toward IR sensor on the front of the system.

The timer is not working.

- ✓ Check the set is switched off
- ✓ Set the clock correctly.
- ✓ Press TIMER to switch on the timer.

The Clock/Timer setting is erased.

- ✓ Power has been interrupted or the power cord has been disconnected. Reset the clock/timer.

The USB device doesn't play on my MCM239.

- ✓ It is not set in the USB mode. Select USB mode.
- ✓ The device is not securely connected to MCM239's USB port. Re-connect the device.
- ✓ The device is not supported by MCM239, or the audio file format stored on the device is not supported by MCM239. Use a compatible device/ playable audio file format.