

Docking Entertainment System

MCM138D

Register your product and get support at
www.philips.com/welcome

User manual

使用説明



PHILIPS

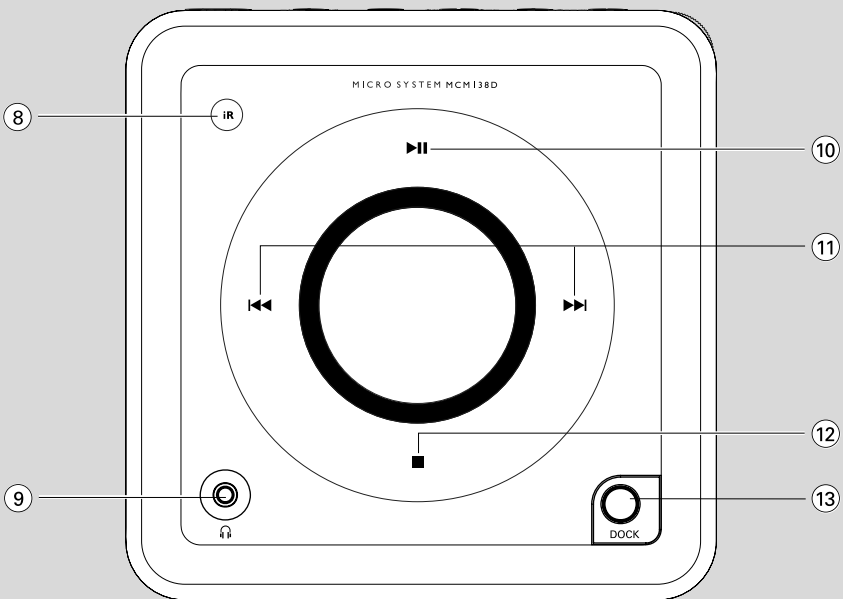
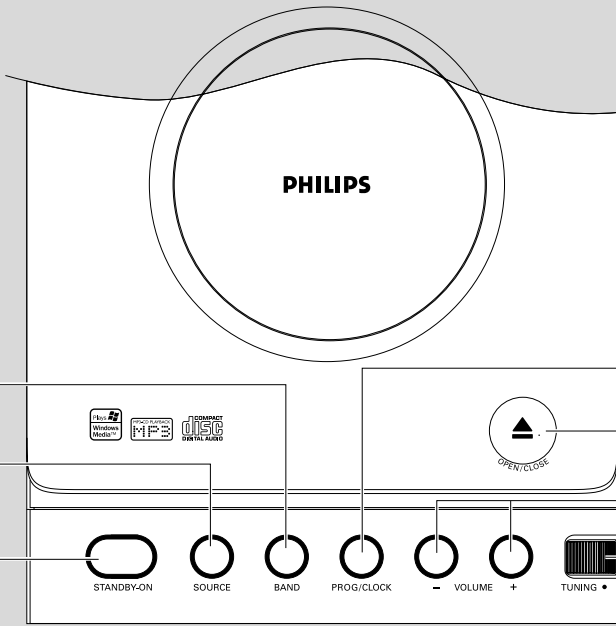

Hearing Safety

Listen at a moderate volume.

- Using headphones at a high volume can impair your hearing. This product can produce sounds in decibel ranges that may cause hearing loss for a normal person, even for exposure less than a minute. The higher decibel ranges are offered for those that may have already experienced some hearing loss.
- Sound can be deceiving. Over time your hearing "comfort level" adapts to higher volumes of sound. So after prolonged listening, what sounds "normal" can actually be loud and harmful to your hearing. To guard against this, set your volume to a safe level before your hearing adapts and leave it there.

To establish a safe volume level:

- Set your volume control at a low setting.
- Slowly increase the sound until you can hear it comfortably and clearly, without distortion.

Listen for reasonable periods of time:

- Prolonged exposure to sound, even at normally "safe" levels, can also cause hearing loss.
- Be sure to use your equipment reasonably and take appropriate breaks.

Be sure to observe the following guidelines when using your headphones.

- Listen at reasonable volumes for reasonable periods of time.
- Be careful not to adjust the volume as your hearing adapts.
- Do not turn up the volume so high that you can't hear what's around you.
- You should use caution or temporarily discontinue use in potentially hazardous situations.
- Do not use headphones while operating a motorized vehicle, cycling, skateboarding, etc.; it may create a traffic hazard and is illegal in many areas.

English 6

中文 21

CAUTION

Use of controls or adjustments or performance of procedures other than herein may result in hazardous radiation exposure or other unsafe operation.

Contents

General Information

Environmental information	7
Supplied accessories	7
Safety information	7

Preparation

Rear connections	8–9
Before using the remote control	9
Replacing battery (lithium CR2032) into the remote control	9

Controls

Controls on the system and remote control	10
--	----

Basic Functions

Switching the system on	11
Power-saving automatic standby	11
Adjusting volume and sound	11

CD/MP3/WMA Operation

Playing a disc	12
Basic playback controls	12
Playing an MP3/WMA disc	12
Different play modes: Shuffle and Repeat	13
Programming track numbers	13
Reviewing the programme	13
Erasing the programme	13

Radio Reception

Tuning to radio stations	14
--------------------------------	----

Clock/Timer

Setting the clock	15
Setting the timer	15
Activating and deactivating TIMER	15
Activating and deactivating SLEEP	15

DOCK

Playing iPod using the dock.....	16
Compatible portable player	
Dock	
Dock adaptor	
Selecting the correct dock adaptor	
Installing the dock adaptor.....	17
Removing the dock adaptor.....	17
Playing iPod.....	17
Charging iPod battery using the dock	17

Troubleshooting

.....	18–19
-------	-------

Specifications

.....	20
-------	----

Maintenance

.....	20
-------	----

Congratulations on your purchase and welcome to Philips!

To fully benefit from the support that Philips offers, register your product at www.philips.com/welcome.

IMPORTANT!

-The voltage selector located at the back panel of this system is preset at 220V-240V from the factory. For countries that operate at 110V-127V, please adjust to 110V-127V before you switch on the system.

Supplied accessories

- 2 speaker boxes
- MCM138D remote control with battery
- MW loop antenna
- Docking kit
 - 1 dock used for Apple iPod
 - Dock adaptors (4 adaptors for different iPod types)

Environmental Information

All unnecessary packaging has been omitted. We have tried to make the packaging easy to separate into three materials: cardboard (box), polystyrene foam (buffer) and polyethylene (bags, protective foam sheet).

Your system consists of materials which can be recycled and reused if disassembled by a specialized company. Please observe the local regulations regarding the disposal of packaging materials, exhausted batteries and old equipment.

Safety Information

- Before operating the system, check that the operating voltage indicated on the typeplate (or the voltage indication beside the voltage selector) of your system is identical with the voltage of your local power supply. If not, please consult your dealer.
- Place the system on a flat, hard and stable surface.
- Where the MAINS plug or an appliance coupler is used as the disconnet device, the disconnet device shall remain readily operable.

- Install the unit near the AC outlet and where the AC power plug can be easily reached.
- The apparatus shall not be exposed to dripping or splashing.
- Place the system in a location with adequate ventilation to prevent internal heat build-up in your system. Allow at least 10 cm (4 inches) clearance from the rear and the top of the unit and 5 cm (2 inches) from each side.
- The ventilation should not be impeded by covering the ventilation openings with items, such as newspapers, table-cloths, curtains, etc.
- Do not expose the system, batteries or discs to excessive moisture, rain, sand or heat sources caused by heating equipment or direct sunlight.
- No naked flame sources, such as lighted candles, should be placed on the apparatus.
- No objects filled with liquids, such as vases, shall be placed on the apparatus.
- If the system is brought directly from a cold to a warm location, or is placed in a very damp room, moisture may condense on the lens of the disc unit inside the system. Should this occur, the CD player would not operate normally. Leave the power on for about one hour with no disc in the system until normal playback is possible.
- The mechanical parts of the set contain self-lubricating bearings and must not be oiled or lubricated.
- Batteries (battery pack or batteries installed) shall not be exposed to excessive heat such as sunshine, fire or the like.
- **When the system is switched to Standby mode, it is still consuming some power. To disconnect the system from the power supply completely, remove the AC power plug from the wall socket.**

Preparations

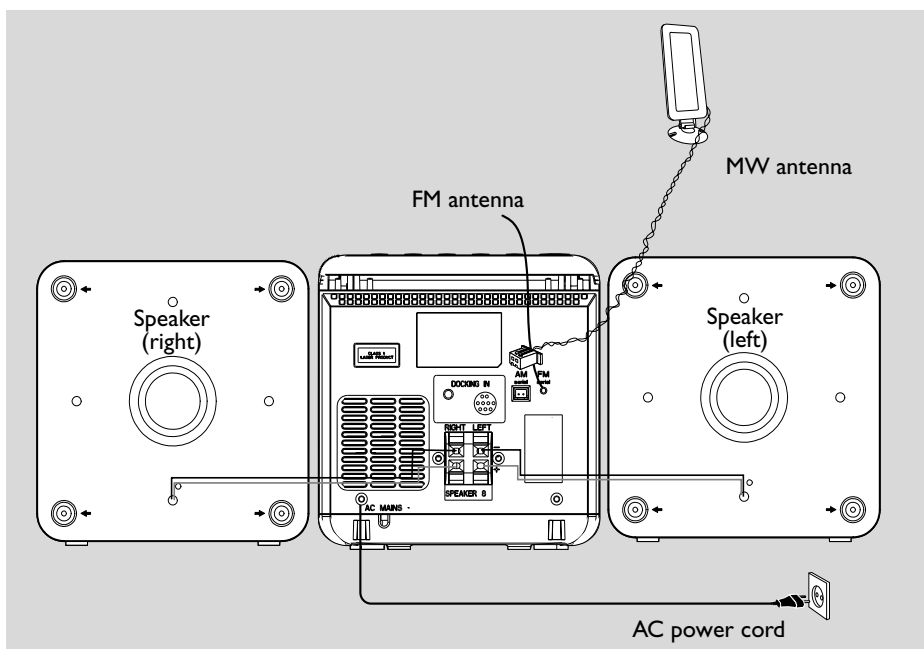

Rear connections

The type plate is located at the rear of the system.

A Power

- Before connecting the AC power cord to the wall outlet, ensure that all other connections have been made.
- If your system is equipped with a Voltage Selector, set the VOLTAGE SELECTOR to the local power line voltage.

WARNING!

- For optimal performance, use only the original power cable.
- Never make or change any connections with the power switched on.

B Antennas Connection

AM (MW) antenna

- 1 Unfold the loop antenna and if necessary, use screws (not supplied) to fix it to a flat, hard and stable place:

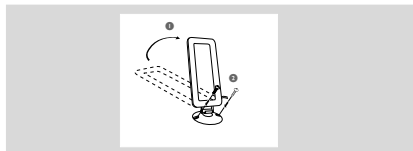

- 2 Fit the plug of the loop antenna to AM ANTENNA as shown above.
- 3 Adjust the antenna for optimal reception

FM Antenna

It is unnecessary to connect the FM pigtail antenna since it is fixed to the main unit.

- Position the antenna as far as possible from a TV, VCR or other radiation source.

Ⓒ Speakers Connection

Front Speakers

Connect the speaker wires to the SPEAKERS terminals, right speaker to "RIGHT" and left speaker to "LEFT", the wire (marked red) to "+ " and the wire (marked black) to "-".

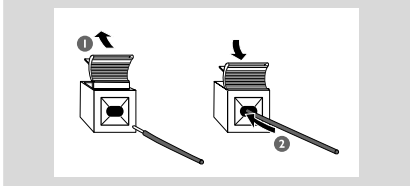

- Fully insert the stripped portion of the speaker wire into the terminal as shown.

Notes:

- For optimal sound performance, use the supplied speakers.
- Do not connect more than one speaker to any one pair of + / - speaker terminals.
- Do not connect speakers with an impedance lower than the speakers supplied. Please refer to the SPECIFICATIONS section of this manual.

Before using the remote control

- 1 Pull out the plastic protective sheet.
- 2 Select the source you wish to control by pressing one of the source select keys on the remote control (for example CD,TUNER).
- 3 Then select the desired function (for example ►, ◀, ▶).

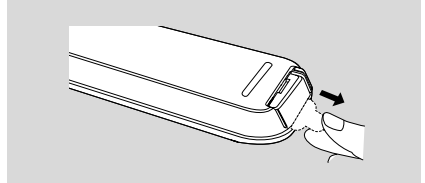

Replacing battery (lithium CR2032) into the remote control

- 1 Pull out the knob (A) slightly to the left.
- 2 Pull out the battery compartment (B) .
- 3 Replace a new battery and fully insert the battery compartment back to the original position.

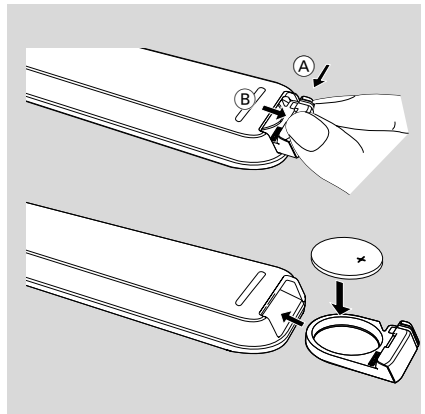

CAUTION!

Batteries contain chemical substances, so they should be disposed off properly.

Controls (illustrations on page 3)

Controls on the system and remote control

- ① **BAND**
 - for Tuner..... (on the set only) selects waveband.
- ② **SOURCE (CD/TUNER/DOCK)**
 - switches on the system.
 - selects the respective sound source for CD/ FM/ MW/ DOCK.
- ③ **STANDBY-ON / ⏻**
 - switches the system to standby/on.
- ④ **PROG/CLOCK**
 - for CD programs tracks and reviews the program.
 - for clock sets the clock function.
- ⑤ **OPEN-CLOSE**
 - opens/closes the CD door.
- ⑥ **VOLUME - / +**
 - adjusts volume level.
- ⑦ **TUNING ●**
 - tunes to radio stations.
- ⑧ **IR SENSOR**
 - infrared sensor for remote control.
- ⑨ **🎧**
 - connect headphones.
- ⑩ **▶ ||**
 - for CD starts or pauses CD playback.
- ⑪ **◀◀ / ▶▶**
 - skips to the beginning of a current track/previous/ next track.
 - fast searches back and forward within a track/ CD.
- ⑫ **STOP ■**
 - stops CD playback or erase a CD program.
- ⑬ **DOCK**
 - selects sound source of DOCK
- ⑭ **MUTE**
 - switches playback sound off and on.
- ⑮ **REPEAT**
 - repeats a track/ disc/all programmed tracks.
- ⑯ **SHUFF (SHUFFLE)**
 - plays CD/MP3 tracks in random order.
- ⑰ **SLEEP**
 - activates/deactivates or selects the sleeper time.

- ⑱ **TIMER**
 - activates/deactivates or sets the timer function.
- ⑲ **ALBUM ▼ ▲**
 - for MP3/WMA disc.....selects an album.
- ⑳ **DBB**
 - (Dynamic Bass Boost) enhances the bass.
- ㉑ **DSC**
 - (Digital Sound Control) selects sound characteristics: JAZZ/POP/CLASSIC/ROCK.

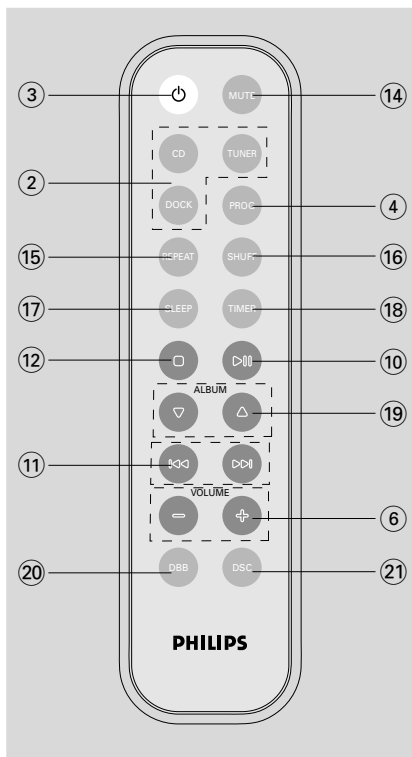

Notes for remote control:

- First select the source you wish to control by pressing one of the source select keys on the remote control (for example CD , TUNER).
- Then select the desired function (for example ▶ , ◀ , ▶▶).

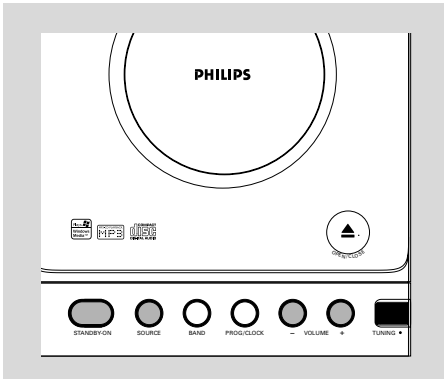

IMPORTANT:
Before you operate the system, complete the preparation procedures.

Switching the system on

- In standby, press **STANDBY-ON** (⏻ on the remote control).
 → The system will switch to the last selected source.
- Press **SOURCE** (CD, TUNER or DOCK on the remote control).
 → The system will switch to the selected source.



To switch the system to standby mode

- Press **STANDBY-ON** (⏻ on the remote control).
 → The clock is displayed.

Power-saving automatic standby

The power-saving feature automatically switches to standby 15 minutes after a CD/iPod playback has ended and no control is operated.

Adjusting volume and sound

- 1 Press **VOLUME - / +** to increase or decrease volume.
 → Display shows the volume level  and a number from 0-32.
- 2 Press **DSC** repeatedly to select the desired sound effect: **JAZZ / POP / CLASSIC / ROCK**.
- 3 Press **DBB** (on the remote control) to switch bass enhancement on or off.
 → Display shows:  if the DBB is activated.
- 4 Press **MUTE** on the remote control to stop sound play-back instantly.
 → Playback will continue without sound and the display shows **MUTE** .

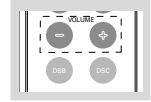

- To start sound playback you can:
 - press **MUTE** again;
 - adjust the volume controls;
 - change source.

CD/MP3/WMA Operation

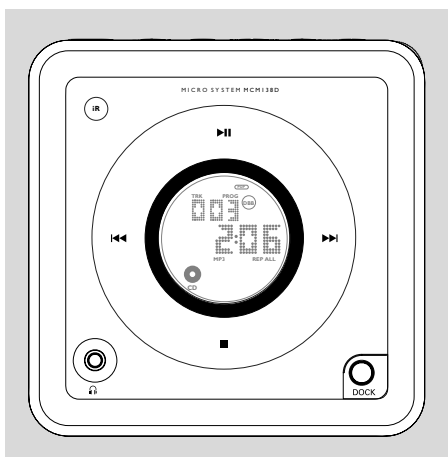

IMPORTANT:

The lens of the CD player should never be touched.

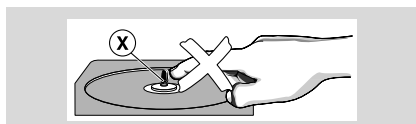

Loading a disc

This CD player plays Audio Discs including CD-Recordables, CD-Rewritables, MP3 CD and WMA CD.



- CD-ROM, CD-I, CDV, VCD, DVD or computer CDs, however, are not possible.

- 1 Select **CD** source.
- 2 Press **OPEN/CLOSE▲** on the top of the system to open the CD compartment.
→ **OPEN** is displayed when you open the CD compartment.
- 3 Insert a disc with the printed side facing up and press down on **OPEN/CLOSE▲** to close the CD door.

→ **REPEAT** is displayed as the CD player scans the contents of a disc, and then the total number of tracks and playing time (or the total number of albums and tracks for MP3/WMA disc) are shown.

Basic playback controls

To play a disc

- Press **▶||** to start playback.
→ The current track number and elapsed playing time of the track are displayed during disc playback.

To select a different track

- Press **◀◀ ▶▶** once or repeatedly until the desired track number appears in the display.

To find a passage within a track

- 1 Press and hold down on **◀◀ ▶▶**.
→ The disc is played at high speed and low volume.
- 2 When you recognise the passage you want, release **◀◀ ▶▶**.
→ Normal playback continues.

To interrupt playback

- Press **▶||** during playback.
→ The display freezes and the elapsed playing time flashes when playback is interrupted.
→ To resume, press **▶||** again.

To stop playback

- Press **■**.

Notes: CD play will also stop when;
– the CD door is opened.
– the disc has reached the end.
– you select another source: **TUNER**.
– you select standby

Playing an MP3, WMA disc

- 1 Load an MP3/WMA disc.
→ The disc reading time may exceed 10 seconds due to the large number of songs compiled into one disc.
→ "xxx xyy" is displayed. xxx is the current track number and yyy is the current album number.
- 2 Press **ALBUM ▼ ▲** to select a desired album.

- 3 Press **⏮** **⏭** to select a desired track.
→ The album number will change accordingly as you reach the first track of an album by pressing **⏮** or the last track of an album by pressing **⏭**.
- 4 Press **▶||** to start playback.
- During playback, press once **ALBUM ▼ ▲** to show the current album number.

Supported MP3 disc formats:

- ISO9660, Joliet, UDF 1.5
- Maximum title number: 512 (depending on filename length)
- Maximum album number: 99
- Supported sampling frequencies: 32 kHz, 44.1 kHz, 48 kHz
- Supported Bit-rates: 32~256 (kbps), variable bitrates

Different play modes: SHUFFLE and REPEAT

You can select and change the various play modes before or during playback. The REPEAT modes can also be combined with PROGRAMME.

SHUFFLE tracks of the entire disc are played in random order

REPEAT ALL ...repeats the entire disc/ programme

REPEAT plays the current track continuously

REPEAT ALB ...repeats all tracks in the current (for MP3/WMA only) album

- 1 To select your play mode, press the **SHUFF** or **REPEAT** on the remote control before or during playback until the display shows the desired function.
- 2 Press **▶||** (on the remote control **▶||**) to start playback if in the STOP position.
→ If you have selected SHUFFLE, playback starts automatically.
- 3 To return to normal playback, press **SHUFF** or **REPEAT** on the remote control until the various SHUFFLE/ REPEAT modes are no longer displayed.
- You can also press **■** to cancel your play mode.

Notes:

- The **SHUFFLE** and **REPEAT** functions cannot be used simultaneously.
- **SHUFFLE** play is not available in the programme mode.

Programming track numbers

Programme in the STOP position to select and store your disc tracks in the desired sequence. If you like, store any track more than once. Up to 40 tracks can be stored in the memory.

- 1 In the stop position, use the **⏮** **⏭** to select your desired track number.
- For MP3/WMA, you may press **ALBUM ▼ ▲** to select a desired album, then press **⏮** **⏭** to select your desired track.
- 2 Press **PROGRAM** (or **PROG/CLOCK** on the set) to store.
→ Display: **PROG** flashes, and **Ⓜ** **1** is displayed briefly, then the selected track number (and the selected album number for MP3/WMA).
- 3 Repeat **steps 1-2** to select and store all desired tracks.
→ **FULL** is displayed if you attempt to programme more than 40 tracks.
- 4 To start playback of your disc programme, press **▶||**.

Reviewing the programme

- Stop playback and press **PROGRAM** (or **PROG/CLOCK** on the set) repeatedly.
→ Display first shows a programme sequence, then the stored track number (and the album number for MP3/WMA).
- To exit review mode, press **■**.

Erasing the programme

You can erase the programme by:

- pressing **■** once in the STOP mode;
- pressing **■** twice during playback;
- opening the CD compartment;
- Select another sound source.
→ **PROG** disappears from the display.

Radio Reception

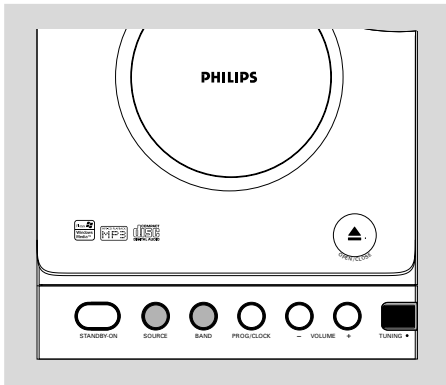

- 3 Turn **TUNING** ● to tune to a station.
→ Display shows: the frequency of the tuned station.

Helpful hints:

To improve radio reception:

- For **FM**, extend coil antenna at the back of the unit fully for optimum reception.

Tuning to radio stations

- 1 Select **TUNER** source.
→  is displayed.
- 2 Press **BAND** (**TUNER** on the remote control) once or more to select your waveband.

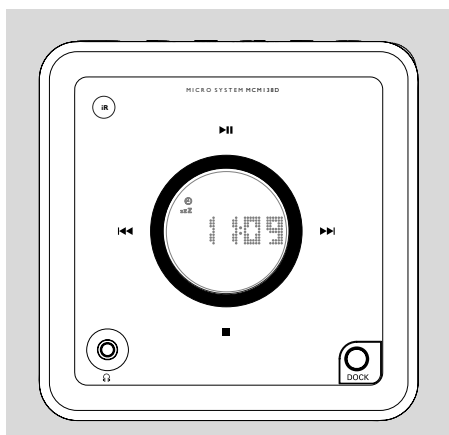

Setting the clock

- 1 In Standby mode, press **PROG/CLOCK** button.
→ The clock digits for the hours flash.
- 2 Press **◀◀ / ▶▶** to set the hours.
- 3 Press **PROG/CLOCK** again.
→ The clock digits for the minutes flash.
- 4 Press **◀◀ / ▶▶** to set the minutes.
- 5 Press **PROG/CLOCK** to confirm the time.

Note:

– If the clock has not been set, – : – will be displayed.

Setting the timer

- The system can be used as an alarm clock. CD or TUNER or DOCK can be set to switch on at a preset time. The clock time needs to be set first before the timer can be used.
 - If no button is pressed within 90 seconds during timer setup, the system will exit timer setting mode automatically.
- 1 In standby or during playback, press **TIMER** on the remote control for more than 2 seconds.
 - 2 Press **◀◀ / ▶▶** (or **CD/TUNER/DOCK** on the remote control) to select sound source.
 - 3 Press **TIMER** to confirm your desired source.
→ The clock digits for the hours flash.

- 4 Press **◀◀ / ▶▶** to set the hours.
- 5 Press **TIMER** again.
→ The clock digits for the minutes flash.
- 6 Press **◀◀ / ▶▶** to set the minutes.
- 7 Press **TIMER** to confirm the time.
→ The timer is now set and actiated.

Notes:

- If source **CD** is selected and no disc is in the CD tray or the disc has an error, **TUNER** will be selected automatically.
- If source **DOCK** is selected and no iPod is docked or no dock connection is made, **TUNER** will be selected automatically.

To activate and deactivate timer

- In standby or during playback, press **TIMER** once.
→ Display shows  if activated, and disappears if deactivated.

Activating and deactivating SLEEP

The sleep timer enables the system to switch off by itself after a set period of time. The clock time needs to be set first before the sleep timer can be used.

- Press **SLEEP** on the remote control repeatedly to select desired time before system shuts off.
→ Display shows **SLEEP** and series of time options for selection: 60, 45, 30, 15, 0, 60 ...
- To deactivate, press **SLEEP** on the remote control once or more until " " is shown, or press **STANDBY ON** on the system or remote control.



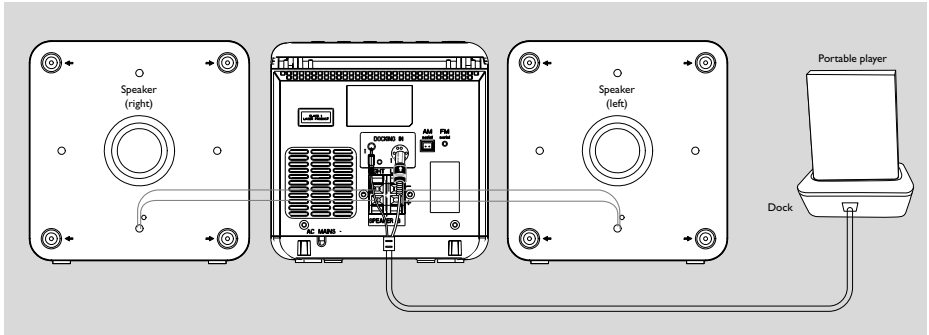

Playing iPod using the dock

By connecting the supplied dock to your Hi-Fi system, you can listen to the sound of the docked player through the powerful speakers of the Hi-Fi system.

Compatible portable player

- Apple iPod models with 30-pin dock connector as follows:
Nano 1st /2nd/3rd generation, iPod 5th generation (video), iPod touch and iPod classic.

Dock

This system comes with a dock used for iPod. Connect the cable of the dock to the system to let the system and your iPod work together.

Dock adaptor

Before plugging your player in the dock, snap the suitable dock adaptor into the dock to provide a snug fit for the player to be docked.

Selecting the correct dock adaptor

- 4 iPod dock adaptors are included. Each adaptor has indication to match different iPod types.

Installing the dock adaptor

- 1 Align two holes of the dock and two latches of the adaptor; then gently push in the adaptor until it clicks.

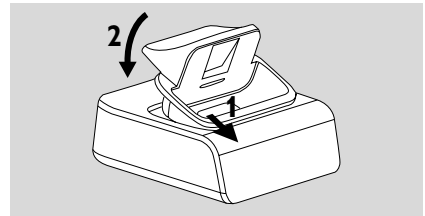

Removing the dock adaptor

- Slightly push down the dock adaptor; as indicated in the figure below, to un-latch the adaptor; then take it out.

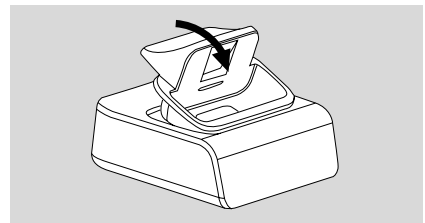

Playing iPod

- 1 Select the dock adaptor of the correct type, and snap it into the dock (See " **Dock adaptor** ").
 - 2 Correctly place your iPod in the dock.
 - 3 Connect the cables of the dock to **DOCKING IN** jacks on the main set correspondingly.
 - 4 Press **SOURCE** repeatedly or **DOCK** to select DOCK source.
- The connected player will play automatically.

Notes:

- By using the buttons (▶||, ◀◀, ▶▶ and **VOLUME**) on the MCM138D and its remote control, the following iPod playback features are available: Play/Pause, selecting next/previous track, fast forwarding/rewinding and changing volume.
- The buttons (▶||, ◀◀, ▶▶ and **VOLUME**) on the MCM138D and its remote control can work only with playback of the audio contents stored on the docked player.
- Stop (■) function of disc playback is not available to the docked player.

Charging iPod battery using the dock

Docking your iPod and connecting the dock to MCM138D, you can charge the iPod in the standby mode and power-on mode of MCM138D.

Troubleshooting

WARNING

Under no circumstances should you try to repair the system yourself, as this will invalidate the warranty. Do not open the system as there is a risk of electric shock.

If a fault occurs, first check the points listed below before taking the system for repair. If you are unable to remedy a problem by following these hints, consult your dealer or service centre.

Problem	Solution
"no cd" is displayed.	<ul style="list-style-type: none">✓ Insert a disc.✓ Check if the disc is inserted upside down.✓ Wait until the moisture condensation at the lens has cleared.✓ Replace or clean the disc, see "Maintenance".✓ Use a finalised CD-RW or CD-R, or a correct MP3-CD format disc.
Radio reception is poor.	<ul style="list-style-type: none">✓ If the signal is too weak, adjust the antenna for better reception.✓ Increase the distance between the Micro HiFi System and your TV or VCR.
The system does not react when buttons are pressed.	<ul style="list-style-type: none">✓ Remove and reconnect the AC power plug and switch on the system again.
Sound cannot be heard or is of poor quality	<ul style="list-style-type: none">✓ Adjust the volume.✓ Disconnect the headphones.✓ Check that the speakers are connected correctly.✓ Check if the stripped speaker wire is clamped.✓ Make sure the MP3-CD was recorded within 32-256 kbps bit rate with sampling frequencies at 48 kHz, 44.1 kHz or 32 kHz.
The left and right sound outputs are reversed.	<ul style="list-style-type: none">✓ Check the speaker connections and location.
The remote control does not function properly.	<ul style="list-style-type: none">✓ Select the source (CD or TUNER, for example) before pressing the function button (▶, ◀, ▶).✓ Reduce the distance between the remote control and the system.✓ Insert the batteries with their polarities (+/- signs) aligned as indicated.✓ Replace the batteries.✓ Point the remote control directly toward IR sensor on the front of the system.

Problem	Solution
<p>The timer is not working.</p>	<ul style="list-style-type: none"> ✓ Set the clock correctly. ✓ Press TIMER to switch on the timer.
<p>The Clock/Timer setting is erased.</p>	<ul style="list-style-type: none"> ✓ Power has been interrupted or the power cord has been disconnected. Reset the clock/timer.
<p>The menu navigation or photo playback of the docked player cannot be carried out through the buttons on MCM138D or its remote control.</p>	<ul style="list-style-type: none"> ✓ The buttons on MCM138D and its remote control can only control playback of audio contents. To navigate the menu, use the controls on the docked player.
<p>The STOP ■ and some buttons on MCM138D and its remote control have no function.</p>	<ul style="list-style-type: none"> ✓ The playback of the docked player cannot be stopped using the STOP ■ button on MCM138D and its remote control. ✓ The buttons (▶ , ◀◀, ▶▶ and VOLUME) can function only.

Specifications

AMPLIFIER

Output power 2 x 2W
..... 4W total power
Signal-to-noise ratio ≥ 62 dBA (IEC)
Frequency response 125 – 16000 Hz, ± 3 dB
Impedance loudspeakers 8 Ω
Impedance headphones 32 Ω

CD PLAYER

Frequency range 20 – 20000 Hz
Signal-to-noise ratio 62 dBA

TUNER

FM wave range 87.5 – 108.5 MHz
MW wave range 515 – 1630 kHz
Sensitivity at 75 Ω
– mono, 26 dB signal-to-noise ratio 3.8 μ V
– stereo, 46 dB signal-to-noise ratio 61.4 μ V
Selectivity ≥ 28 dB
Total harmonic distortion $\leq 5\%$
Frequency response 63 – 12500 Hz (± 3 dB)
Signal-to-noise-ratio ≥ 50 dB

SPEAKERS

Bass reflex system
Dimensions (w x h x d) . 150 x 153 x 204 (mm)

GENERAL INFORMATION

AC Power 110 – 127 / 220 – 240 V
..... 50/60 Hz, switchable
Dimensions (w x h x d) .. 150 x 153 x 244 (mm)
Weight (with/without speakers)
..... approx. 4.9 / 2.3 kg

Subject to modification.

Maintenance

Cleaning the Cabinet

- Use a soft cloth slightly moistened with a mild detergent solution. Do not use a solution containing alcohol, spirits, ammonia or abrasives.

Cleaning Discs

- When a disc becomes dirty, clean it with a cleaning cloth. Wipe the disc from the centre out.
- Do not use solvents such as benzene, thinner, commercially available cleaners, or antistatic spray intended for analogue records.

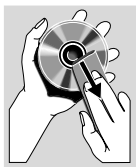

Cleaning the disc lens

- After prolonged use, dirt or dust may accumulate at the disc lens. To ensure good playback quality, clean the disc lens with Philips CD Lens Cleaner or any commercially available cleaner. Follow the instructions supplied with cleaner.



Be responsible
Respect copyrights

規格更改恕不另行通知。
商標為荷蘭皇家飛利浦電子股份有限公司或
其各自所有者的專有財產。
2008 © 荷蘭皇家飛利浦電子股份有限公司。版權所有。

