

Quick Start Guide



Step A *Connect*

Step B *Setup*

Step C *Enjoy*

What's in the Box?

You should find these items upon opening the box.

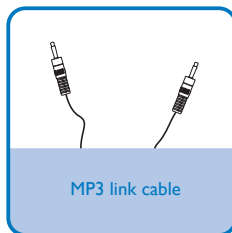
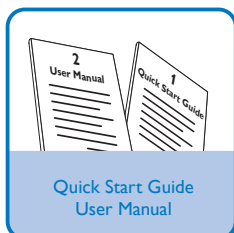
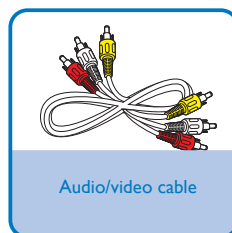
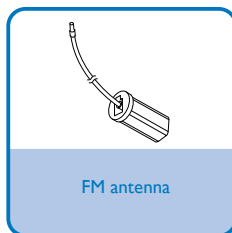

PHILIPS

Step A **Connect**

- 1 Connect the speaker cables.
- 2 Connect the AC power cord to AC~MAINS jack on the main unit, and the wall socket.

Tip

See the User Manual for how to connect other equipment to this apparatus.

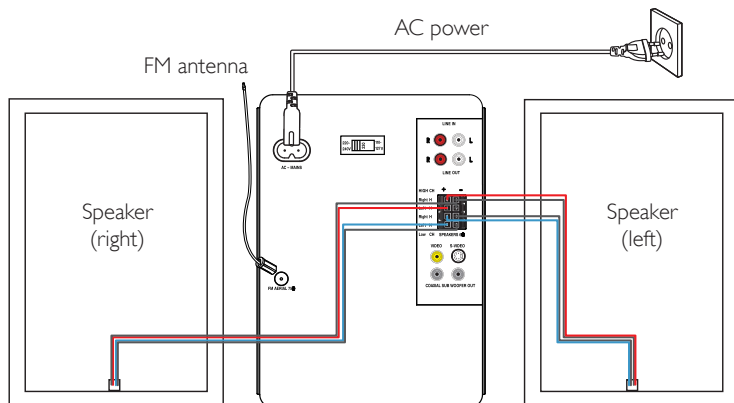

Step B **Setup**

Setting the clock

- 1 In standby mode, press and hold **CLOCK/DISPLAY**.
- 2 Press **VOL+/-** to set the hour.
- 3 Press **CLOCK/DISPLAY** to confirm.
- 4 Press **VOL+/-** to set the minute.
- 5 Press **CLOCK/DISPLAY** again to confirm the time setting.

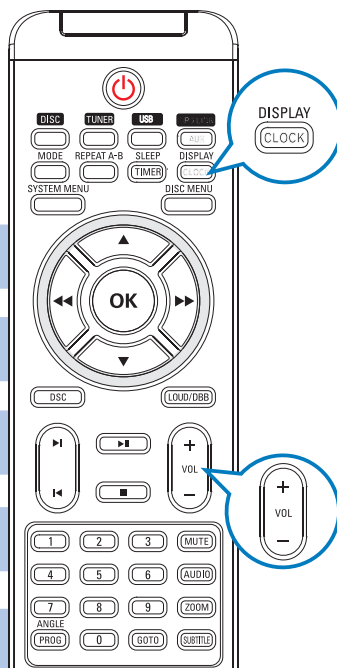

Step C Enjoy

Playing a disc

- 1 Press **DISC** to select DISC.
- 2 Press **▲** to open the disc compartment.
- 3 Insert a disc with the printed side facing up, then close the disc door.
- 4 Playback will start automatically. If not, press **▶II**.
- 5 To stop playback, press **■**.

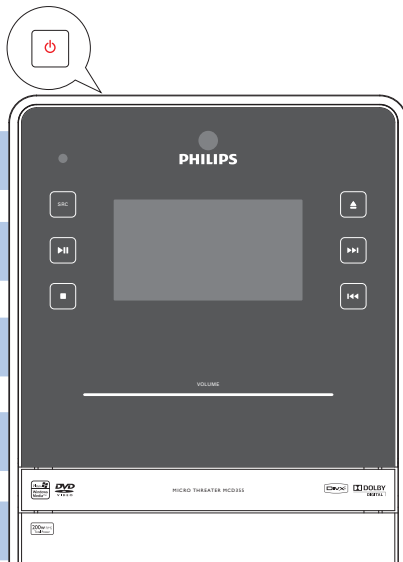

Playing a USB mass storage device

With the apparatus, you can use USB flash memory (USB 2.0 or USB1.1), USB flash players (USB 2.0 or USB1.1), memory cards (requires an additional card reader to work with this apparatus).

- 1 Insert the USB device's USB plug into the socket  on the main unit.
- 2 Press **USB**.
- 3 Press **▲▼** to select a folder.
- 4 Press **◀/▶** to select a file.
- 5 Press **▶II** to pause or resume play.
- 6 To stop play, press **■**.

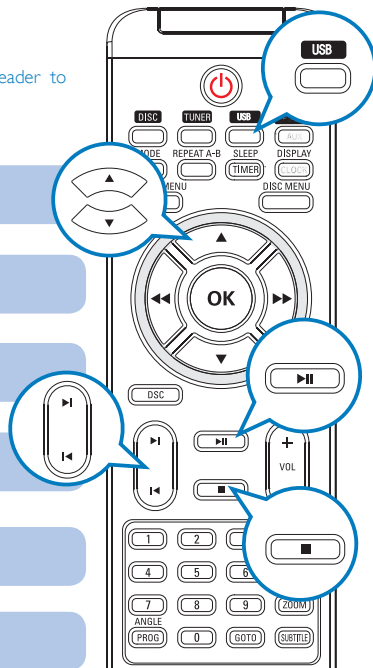

Programming and tuning to radio stations

- 1 Press **TUNER** to select tuner source.
- 2 Press **PROG/ANGLE** for more than two seconds to program all available stations in order of waveband.
- 3 Press **◀** or **▶** until the desired preset station is displayed.

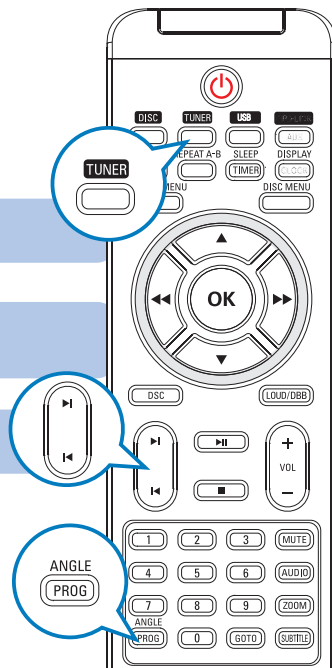

Tip

Detailed playback features and additional functions are described in the accompanied owner's manual.



© Royal Philips Electronics N.V. 2009
All rights reserved.

<http://www.philips.com>

