

Register your product and get support at
www.philips.com/welcome

MCD107



EN	User manual	3
ZH-TW	使用手冊	29

PHILIPS

Contents

1 Important	4	7 Adjust sound	19
Safety	4	Adjust volume level	19
Notice	6	Select a preset sound effect	19
		Enhance bass	19
		Mute sound	19
2 Your DVD Micro Theater	7		
Introduction	7	8 Adjust settings	19
What's in the box	7	System settings	19
Overview of the main unit	8	Playback settings	20
Overview of the remote control	9	Video settings	21
		Audio settings	22
3 Connect	11		
Preparations	11	9 Other features	23
Connect speakers	11	Set the alarm timer	23
Connect TV	11	Set the sleep timer	23
Connect power	12	Listen to an external device	23
4 Get started	13	10 Product information	24
Prepare the remote control	13	Specifications	24
Auto install radio stations	13	USB playability information	25
Set clock	13	Supported MP3 disc formats	25
Turn on	14		
Set up the TV	14	11 Troubleshooting	25
		No sound or poor sound	25
5 Play	15		
Play discs	15	12 Glossary	27
Play from USB devices	15		
Play DivX video	15		
View pictures	16		
Play control	16		
Play options	17		
6 Listen to radio	18		
Tune to a radio station	18		
Program radio stations automatically	18		
Program radio stations manually	18		
Select a preset radio station	18		

1 Important

Safety

Know these safety symbols

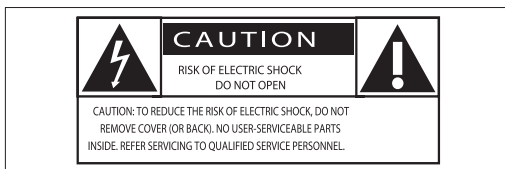

This 'bolt of lightning' indicates uninsulated material within your unit may cause an electrical shock. For the safety of everyone in your household, please do not remove product covering.

The 'exclamation point' calls attention to features for which you should read the enclosed literature closely to prevent operating and maintenance problems. **WARNING:** To reduce the risk of fire or electric shock, this apparatus should not be exposed to rain or moisture and objects filled with liquids, such as vases, should not be placed on this apparatus.

CAUTION: To prevent electric shock, match wide blade of plug to wide slot, fully insert.

- ① Read these instructions.
- ② Keep these instructions.
- ③ Heed all warnings.
- ④ Follow all instructions.
- ⑤ Do not use this apparatus near water.
- ⑥ Clean only with dry cloth.

- ⑦ Do not block any ventilation openings. Install in accordance with the manufacturer's instructions.
- ⑧ Do not install near any heat sources such as radiators, heat registers, stoves, or other apparatus (including amplifiers) that produce heat.
- ⑨ Protect the power cord from being walked on or pinched, particularly at plugs, convenience receptacles, and the point where they exit from the apparatus.
- ⑩ Only use attachments/accessories specified by the manufacturer.
- ⑪ Use only with the cart, stand, tripod, bracket, or table specified by the manufacturer or sold with the apparatus. When a cart is used, use caution when moving the cart/apparatus combination to avoid injury from tip-over.
- ⑫ Unplug this apparatus during lightning storms or when unused for long periods of time.
- ⑬ Refer all servicing to qualified service personnel. Servicing is required when the apparatus has been damaged in any way, such as power-supply cord or plug is damaged, liquid has been spilled or objects have fallen into the apparatus, the apparatus has been exposed to rain or moisture, does not operate normally, or has been dropped.
- ⑭ **Battery usage CAUTION** – To prevent battery leakage which may result in bodily injury, property damage, or damage to the unit:
 - Install all batteries correctly, + and - as marked on the unit.
 - Do not mix batteries (old and new or carbon and alkaline, etc.).
 - Remove batteries when the unit is not used for a long time.



- 15 Apparatus shall not be exposed to dripping or splashing.
- 16 Do not place any sources of danger on the apparatus (e.g. liquid filled objects, lighted candles).
- 17 This product may contain lead and mercury. Disposal of these materials may be regulated due to environmental considerations. For disposal or recycling information, please contact your local authorities or the Electronic Industries Alliance: www.eiae.org.
- 18 Where the MAINS plug or an appliance coupler is used as the disconnect device, the disconnect device shall remain readily operable.



Warning

- Never remove the casing of this apparatus.
- Never lubricate any part of this apparatus.
- Never place this apparatus on other electrical equipment.
- Keep this apparatus away from direct sunlight, naked flames or heat.
- Never look into the laser beam inside this apparatus.
- Ensure that you always have easy access to the power cord, plug or adaptor to disconnect this apparatus from the power.



Caution

- Use of controls or adjustments or performance of procedures other than herein may result in hazardous radiation exposure or other unsafe operation.

Hearing safety

Listen at a moderate volume.

- Using headphones at a high volume can impair your hearing. This product can produce sounds in decibel ranges that may cause hearing loss for a normal person, even for exposure less than a minute. The higher decibel ranges are offered for those that may have already experienced some hearing loss.
- Sound can be deceiving. Over time your hearing 'comfort level' adapts to higher volumes of sound. So after prolonged listening, what sounds 'normal' can actually be loud and harmful to your hearing. To guard against this, set your volume to a safe level before your hearing adapts and leave it there.

To establish a safe volume level:

- Set your volume control at a low setting.
- Slowly increase the sound until you can hear it comfortably and clearly, without distortion.

Listen for reasonable periods of time:

- Prolonged exposure to sound, even at normally 'safe' levels, can also cause hearing loss.
- Be sure to use your equipment reasonably and take appropriate breaks.

Be sure to observe the following guidelines when using your headphones.

- Listen at reasonable volumes for reasonable periods of time.
- Be careful not to adjust the volume as your hearing adapts.
- Do not turn up the volume so high that you can't hear what's around you.
- You should use caution or temporarily discontinue use in potentially hazardous situations. Do not use headphones while operating a motorized vehicle, cycling, skateboarding, etc.; it may create a traffic hazard and is illegal in many areas.

Notice

Any changes or modifications made to this device that are not expressly approved by Philips Consumer Lifestyle may void the user's authority to operate the equipment.



Your product is designed and manufactured with high quality materials and components, which can be recycled and reused.



When this crossed-out wheeled bin symbol is attached to a product it means that the product is covered by the European Directive 2002/96/EC.

Please inform yourself about the local separate collection system for electrical and electronic products.

Please act according to your local rules and do not dispose of your old products with your normal household waste. Correct disposal of your old product helps to prevent potential negative consequences for the environment and human health.



Your product contains batteries covered by the European Directive 2006/66/EC, which cannot be disposed with normal household waste. Please inform yourself about the local rules on separate collection of batteries because correct disposal helps to prevent negative consequences for the environmental and human health.

Environmental information

All unnecessary packaging has been omitted. We have tried to make the packaging easy to separate into three materials: cardboard (box), polystyrene foam (buffer) and polyethylene (bags, protective foam sheet.)

Your system consists of materials which can be recycled and reused if disassembled by a specialized company. Please observe the local regulations regarding the disposal of packaging materials, exhausted batteries and old equipment.



Manufactured under license from Dolby Laboratories. Dolby and the double-D symbol are trademarks of Dolby Laboratories.



DivX, DivX Certified, and associated logos are trademarks of DivX, Inc. and are used under license.



Windows Media and the Windows logo are trademarks, or registered trademarks of Microsoft Corporation in the United States and/or other countries.

This apparatus includes this label:



2 Your DVD Micro Theater

Congratulations on your purchase, and welcome to Philips! To fully benefit from the support that Philips offers, register your product at www.Philips.com/welcome.

Introduction

With this unit, you can:

- watch video from DVD/VCD/SVCD or USB devices
- enjoy audio from audio CDs, external devices, or USB devices
- view pictures from discs or USB devices
- listen to FM radio

You can enrich sound output with the following sound effects:

- Digital Sound Control (DSC)
- Dynamic Bass Boost (DBB)

The unit supports the following media formats:



You can play DVDs with the following region code:

DVD region code	Countries
	Asia Pacific, Taiwan, Korea
	Australia, New Zealand





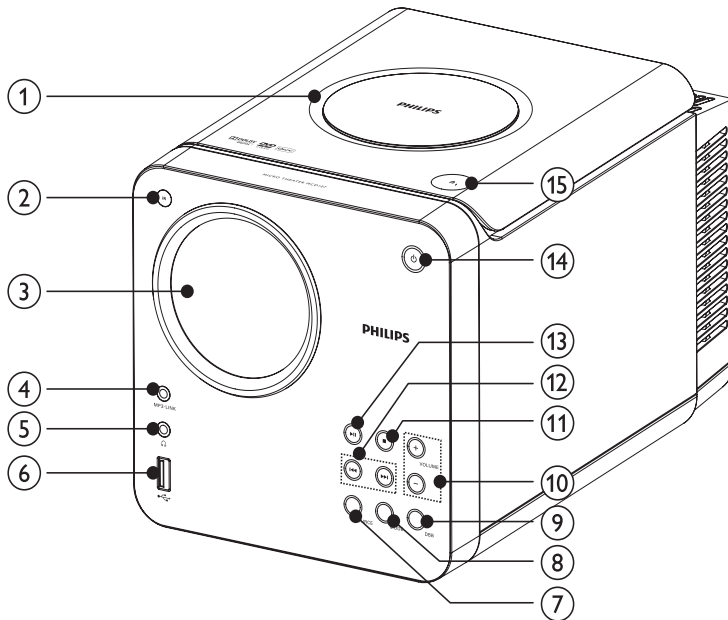

What's in the box

Check and identify the contents of your package:

- Main unit
- Loudspeaker boxes x 2
- Power cord
- Audio/video cable
- MP3 link cable x 1
- Remote control
- Quick start guide
- User manual

Overview of the main unit



- ① **Disc compartment**
- ② **IR**
 - Remote control sensor
- ③ **Display panel**
 - Show current status.
- ④ **MP3 LINK**
 - Jack for an external audio device.
- ⑤ 
 - Headphone jack
- ⑥ 
 - USB socket
- ⑦ **SOURCE**
 - Select a source: Disc, USB, FM tuner, or MP3 link.
- ⑧ **MODE**
 - Select a repeat/shuffle play mode.
- ⑨ **DBB**
 - Turn on or off dynamic bass enhancement.
- ⑩ **VOLUME +/-**
 - Adjust volume.
- ⑪ 
 - Stop play or erase a program.
- ⑫ 
 - Start or pause play.
- ⑬ 
 - Search fast forward or fast backward.
 - Tune to a radio station.
 - Adjust time.
- ⑭ 
 - Turn on the unit, or switch to standby mode.
- ⑮ 
 - Open/close the disc compartment.

Overview of the remote control

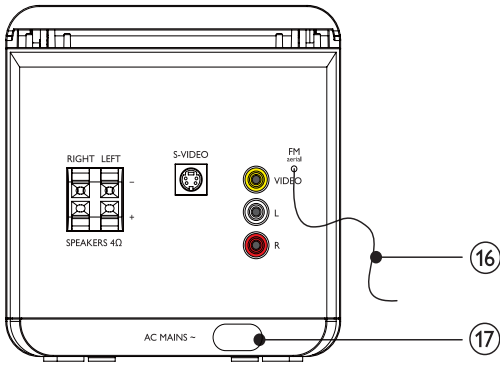

- 16 **FM antenna**
 - Improve FM reception.
- 17 **AC MAINS~**
 - Power cord socket

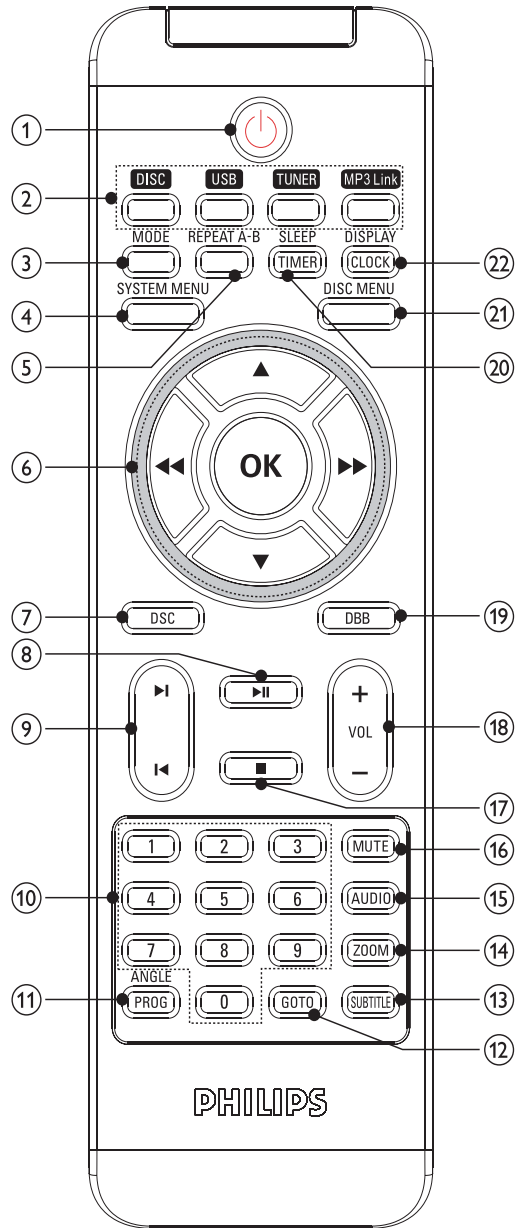

- 1 **⏻**
 - Turn on the unit, switch to standby mode.

- ② **Source selection keys (DISC, USB, TUNER, MP3 Link)**
 - Select a source.
- ③ **MODE**
 - Select a repeat/shuffle play mode.
- ④ **SYSTEM MENU**
 - Access or exit the system setup menu.
- ⑤ **REPEAT A-B**
 - Mark the section for repeat play, or turn off repeat mode.
- ⑥ **◀◀▶▶**
 - Search fast forward or fast backward.
 - Tune to a radio station.
 - Navigate left/right in the disc menu or system setup menu.
 - Adjust time.
- ⑦ **DSC**
 - Select a preset sound setting.
- ⑧ **▶▶**
 - Start or pause play.
- ⑨ **◀/▶**
 - Skip to the previous/next title/ chapter/track.
 - Select a preset radio station.
- ⑩ **Numeric keypad 0-9**
 - Select a specified title/chapter/track directly.
- ⑪ **PROG/ANGLE**
 - Program radio stations.
 - Select a DVD camera angle.
 - Program titles/chapters/tracks.
 - Select 12 hour or 24 hour format.
- ⑫ **GOTO**
 - Skip to a specific section of the disc during play quickly.
- ⑬ **SUBTITLE**
 - Select a subtitle
- ⑭ **ZOOM**
 - Zoom in or out a picture/video image on the TV screen.
- ⑮ **AUDIO**
 - For DVD/DivX video, select an audio language.
 - For VCD, select stereo, mono-left or mono-right MIX MONO output.
- ⑯ **MUTE**
 - Mute or restore audio output.
- ⑰ **■**
 - Stop play or erase a program.
- ⑱ **VOL +/-**
 - Adjust volume.
- ⑲ **DBB**
 - Turn on/off bass enhancement.
- ⑳ **TIMER/SLEEP**
 - Set the sleep timer.
 - Set the alarm timer.
- ㉑ **DISC MENU**
 - Access or exit the disc menu.
- ㉒ **CLOCK/DISPLAY**
 - Set the clock.
 - Display information on the TV screen during play.

3 Connect

Preparations

- 1 Place a soft cloth on a hard, flat, stable surface.
- 2 Place the unit onto the cloth.
- 3 Remove the socket cover.

Connect speakers

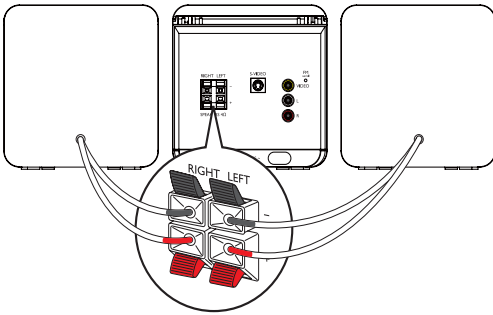

Note

- Ensure that the colors of the speaker wires and terminals are matched.

- 1 Hold down the socket flap.
- 2 Insert the stripped part of the wire completely.
 - Insert the right speaker wires to "RIGHT", left speaker wires to "LEFT".
 - Insert the red wires to "+", black wires to "-".
- 3 Release the socket flap.

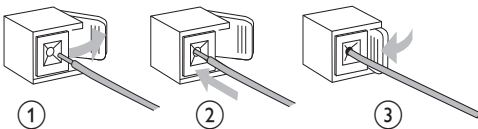

Connect TV

You can watch video from this unit on the TV screen.

- Option 1: Connect through AV cable
- Option 2: Connect through S-Video socket

Option 1: Connect through AV cable

AV out provides basic analogue connectivity.

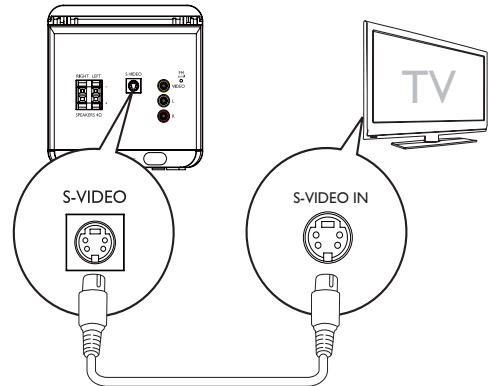

- 1 Connect AV cable (red/white/yellow) to:
 - AV OUT (VIDEO, L, R) sockets on the unit.
 - AV input sockets on the TV.

Tip

- If you want to listen to sound from the unit instead of from TV, connect the video cable (yellow) only. Do not connect the audio cable (red and white).

Option 2: Connect through S-Video socket

S-video provides better picture quality than AV out connections.

- 1 Connect an S-video cable (not supplied) to:
 - the **S-VIDEO** socket on this unit.
 - the S-Video socket on the TV.

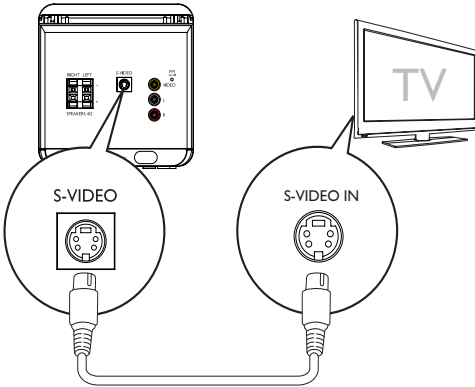

- 1 Switch the voltage selector to the local power line voltage.
- 2 Connect the power cord to the wall outlet.

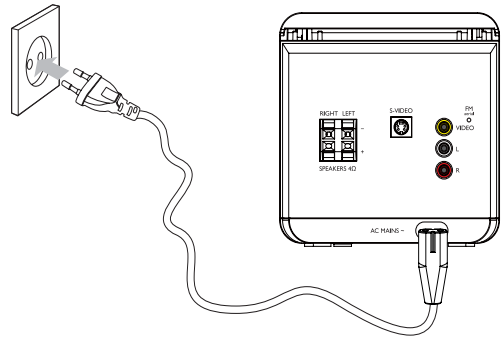

Connect power



Caution

- Risk of product damage! Ensure that the power supply voltage corresponds to the voltage printed on the back or the underside of the unit.
- Risk of electric shock! When you unplug the AC power cord, always pull the plug from the socket. Never pull the cord.
- Before connecting the AC power cord, ensure you have completed all other connections.



Note

- The type plate is located on the rear of the main unit.
- The voltage selector is at the bottom of the main unit.

4 Get started

! Caution

- Use of controls or adjustments or performance of procedures other than herein may result in hazardous radiation exposure or other unsafe operation.

Always follow the instructions in this chapter in sequence.

If you contact Philips, you will be asked for the model and serial number of this apparatus. The model number and serial number are on the rear of the apparatus. Write the numbers here:
Model No. _____
Serial No. _____

Prepare the remote control

! Caution

- Risk of explosion! Keep batteries away from heat, sunshine or fire. Never discard batteries in fire.

For first-time use:

- 1 Remove the protective tab to activate the remote control battery.

To replace the remote control battery:

- 1 Open the battery compartment.
- 2 Insert 1 CR2025 battery with correct polarity (+/-) as indicated.
- 3 Close the battery compartment.

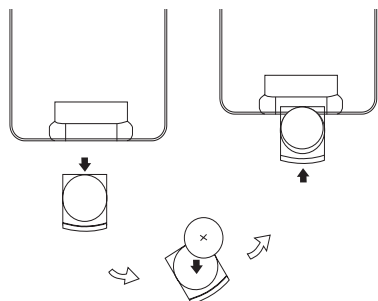

≡ Note

- Before pressing any function button on the remote control, first select the correct source with the remote control instead of the main unit.
- If you are not going to use the remote control for a long time, remove the battery.

Auto install radio stations

When you connect the unit to the power supply for the first time, or no radio station is stored in this unit, Plug and Play is activated to store all available radio stations automatically.

- 1 Connect the unit to the power supply.
↳ [AUTO INSTALL - PRESS PLAY, STOP CANCEL] ((auto install - press the PLAY button; to cancel, press ■) is displayed.
- 2 Press ►|| on the main unit to start installation.
↳ [AUTO] (auto) is displayed.
↳ The unit automatically store radio stations with sufficient signal strength.
↳ When all the available radio stations are stored, the first preset radio station is broadcast automatically.

Set clock

- 1 In standby-by mode, press and hold **CLOCK/DISPLAY** to activate the clock setting mode.
↳ The 12 hour or 24 hour format is displayed.
- 2 Press **PROG** repeatedly to select 12 hour or 24 hour format.
- 3 Press **CLOCK/DISPLAY** to confirm.
↳ The hour digits are displayed and begin to blink.

- 4 Press ◀▶ to set the hour.
- 5 Press **CLOCK/DISPLAY** to confirm.
 - ↳ The minute digits are displayed and begin to blink.
- 6 Press ◀▶ to set the minute.
- 7 Press **CLOCK/DISPLAY** to confirm.



Tip

- To view the clock during play, press **CLOCK/DISPLAY** repeatedly until the clock is displayed.

Set up the TV

- 1 Turn on the unit.
- 2 Press **DISC** to select DISC source.
- 3 Turn on the TV and then select the correct video-in channel.
 - ↳ You should see the blue Philips DVD background screen.



Tip

- See the TV user manual for details of how to select the correct video-in channel.

Turn on

- 1 Press ϕ .
 - ↳ The unit switches to the last selected source.

Switch to standby

- 1 Press ϕ to switch the unit to standby mode.
 - ↳ The backlight on the display panel is dimmed.
 - ↳ The clock (if set) appears on the display panel.

5 Play



Caution

- Risk of damage to the unit! During play, never move the unit.



Note

- If 'INVALID KEY' is displayed, the function is unavailable on this disc/file at this moment.

Play discs



Caution

- Never look at the laser beam inside the unit.
- Risk of product damage! Never play discs with accessories such as disc stabilizer rings or disc treatment sheets.
- Do not push on the disc tray or put any objects other than discs on the disc tray. It may cause the disc player to malfunction.

- 1 Press **DISC** to select the disc source.
- 2 Press **▲** to open the disc compartment.
- 3 Insert a disc with the printed side facing up, then close the disc door.
 - ↳ Play starts automatically.
 - To pause/resume play, press **▶||**.
 - To stop play, press **■**.
 - For MP3/WMA disc: to select an album, press **▲/▼**.
 - To skip to a track/file/chapter, press **◀/▶**.
 - To fast backward/forward, press and hold **◀◀/▶▶**.



Note

- This feature is only available for DVDs/DivX videos recorded with multiple subtitle languages.

- During play, press **SUBTITLE** repeatedly to select a subtitle language.

Play from USB devices



Note

- Ensure that the USB device contains playable content. (see "USB playability information")

- 1 Insert the USB plug of a USB device into the  socket.
- 2 Press **USB**.
 - ↳ Play starts automatically. If not, press **▶||**.
 - To pause/resume play, press **▶||**.
 - To stop play, press **■**.
 - To select an album/folder, press **▲/▼**.
 - To skip to a track/file, press **◀/▶**.
 - To fast backward/forward, press and hold **◀◀/▶▶**.

Play DivX video

You can play DivX files copied onto a CD-R/RW, recordable DVD or USB device.

- 1 Insert a disc or connect a USB device.
- 2 Select a source:
 - For discs, press **DISC**.
 - For USB devices, press **USB**.
- 3 Select a file to play and press **OK**.
 - To stop play, press **■**.
 - To pause or resume play, press **▶||**.
 - To change a subtitle language, press **SUBTITLE**.



Note

- Subtitle files with the following filename extensions (.srt, .smi, .sub, .ssa, .ass) are supported but do not appear on the file navigation menu.
- The subtitle filename has to be the same as the file name of the video.

View pictures

You can view JPEG files as a slide show.

- 1 Insert a picture disc or connect a USB device.
- 2 Select a source:
 - For discs, press **DISC**.
 - For USB devices, press **USB**.
- 3 Press **▶||** to start the slide show.

Slide show play modes

You can view pictures as slide show in different play modes.

- 1 Press **PROG/ANGLE** repeatedly.

View from different angles

- 1 During playback, press **▲▼/◀▶** to rotate the picture.

Play control

Repeat and random play

You can select various repeat functions during playback. The repeat play options vary depending on the disc type.

- 1 Press **MODE** repeatedly to choose a play mode.
 - For DVD
 - **[CHAPTER]** (chapter): repeat the current chapter
 - **[TITILE]** (title): repeat the current title
 - **[REP ALL]** (repeat all): repeat the disc
 - **[SHUF]** (shuffle): play the disc in random order
 - **[OFF]** (off): switch off the repeat mode

- For VCD/MP3/CD/DivX
 - **[REP 1]** (repeat 1): repeat the current track
 - **[REP DIR]** (repeat directory) (for MP3 disc only): repeat the current folder
 - **[REP ALL]** (repeat all): repeat the disc
 - **[SHUF]** (shuffle): play the disc in random order
 - **[OFF]** (off): switch off the repeat mode

- 2 To return to normal play, press **MODE** repeatedly until play mode is no longer displayed.

Note

- Shuffle play cannot be selected when you play programmed tracks.

Repeat A-B (DVD/VCD/CD/MP3/WMA)

- 1 During music or video play, press **REPEAT A-B** at the start point.
- 2 Press **REPEAT A-B** at the end point.
 - ↳ The section starts to play repeatedly.
 - ↳ To cancel repeat play, press **REPEAT A-B** again.

Note

- The section A and B can be set only within the same chapter/track.

Search by time or scene/track number

When playing video or music discs, you can select a scene, track or a specified point.

- 1 During play, press **GOTO** until the time or chapter/track a time field or chapter/track field is displayed.
 - For the time field, enter the play position in hours, minutes and seconds.
 - For the chapter/track field, enter the chapter/track.

Play options

Display play information

- 1 During play, press **CLOCK/DISPLAY** repeatedly to select different play information.

Program

- 1 In stop mode, press **PROG/ANGLE** to enter program mode.
- 2 Press **◀▶▶/▲/▼** to select a preset number.
- 3 Use the numeric keypad to input the track/title number.
 - To exit the program mode, press **PROG/ANGLE**.
- 4 When the program is complete, press **▶||** to start play.
 - To change the program, repeat the steps above.
 - To clear the program, press **■** twice.

Change camera angle

Some DVDs contain alternate scenes, such as scenes recorded from different camera angles. For such DVDs, you can select from the available alternate scenes.

- 1 Press **PROG/ANGLE** repeatedly to switch between camera angles.

Select an audio language

You can select an audio language on DVDs, DiVx video or VCDs.

- 1 During disc play, press **AUDIO**.
 - ↳ The language options appear. If the selected audio channels is unavailable, the default disc audio channel is used.



Note

- For some DVDs, the language can only be changed from the disc menu. Press **DISC MENU** to access the menu.

Zoom in/out image

- 1 During video/picture play, press **ZOOM** repeatedly to zoom in/out the image.
 - When the image is zoomed in, you can press **◀▶▶/▲/▼** to pan through the image.

6 Listen to radio

Tune to a radio station

- 1 Press **TUNER** repeatedly to select FM.
- 2 Press and hold **◀▶** for more than 2 seconds.
 - ↳ [SEARCH] (search) is displayed.
 - ↳ The radio tunes to a station with strong reception automatically.
- 3 Repeat step 2 to tune to more stations.
 - To tune to a weak station, press **◀▶** repeatedly until you find optimal reception.

Program radio stations automatically

Note

- You can program a maximum of 20 preset radio stations.

- 1 In the tuner mode, press and hold **PROG/ANGLE** for more than 2 seconds to activate automatic program mode.
 - ↳ [AUTO] (auto) is displayed.
 - ↳ All available stations are programmed in the order of waveband reception strength.
 - ↳ The first programmed radio station is broadcast automatically.

Program radio stations manually

Note

- You can program a maximum of 20 preset radio stations.

- 1 Tune to a radio station.
- 2 Press **PROG/ANGLE** to activate program mode.
 - ↳ [PROG] blinks on the display.
- 3 Press **◀▶** to allocate a number (1 to 20) to this radio station, then press **PROG/ANGLE** to confirm.
 - ↳ The preset number and the frequency of the preset station are displayed.
- 4 Repeat the steps above to program other stations.

Note

- To overwrite a programmed station, store another station in its place.

Select a preset radio station

- 1 Press **◀▶** to select a preset number.

Tip

- Position the antenna as far as possible from TV, VCR or other radiation source.
- For optimal reception, fully extend and adjust the position of the antenna.

7 Adjust sound

Adjust volume level

- 1 During play, press **VOL +/-** to increase/decrease the volume level.

Select a preset sound effect

- 1 During play, press **DSC** repeatedly to select:
 - [POP] (pop)
 - [JAZZ] (jazz)
 - [CLASSIC] (classic)
 - [ROCK] (rock)

Enhance bass

- 1 During play, press **DBB** to turn on or off dynamic bass enhancement.
 - ↳ If DBB is activated, DBB is displayed.

Mute sound

- 1 During play, press **MUTE** to mute/unmute sound.

8 Adjust settings

System settings

Set screen saver

The screen saver protects the TV screen damage due to prolonged exposure to a static image.

- 1 Press **SYSTEM MENU**.
 - ↳ The system menu is displayed.
- 2 Select **[SYSTEM SETUP]** (system setup) > **[SCREEN SAVER]** (screen saver), then press **▶▶**.
- 3 Select an option, then press **OK**.
 - **[ON]** (on): Enable the screen saver.
 - **[OFF]** (off): Disable the screen saver.
- 4 Press **SYSTEM MENU** to exit.

Restore default settings

You can reset all options and your personal settings to factory default settings.

- 1 Press **SYSTEM MENU**.
- 2 Select **[SYSTEM SETUP]** (system setup) > **[DEFAULT]** (default), then press **▶▶**.
- 3 Select **[RESTORE]** (restore), then press **OK**.
- 4 Press **SYSTEM MENU** to exit.

Playback settings

Select preferred language



Note

- If the selected language is not available on the disc, the default disc language is used.

- 1 Press **SYSTEM MENU**.
- 2 Select **[LANGUAGE SETUP]** (language setup).
- 3 Select an option, then press **▶▶**.
 - **[OSD LANGUAGE]** (OSD language): Select a language for on-screen display.
 - **[AUDIO LANG]** (audio language): Select an audio language for DVD play.
 - **[SUBTITLE LANG]** (subtitle language): Select a subtitle language for DVD play.
 - **[MENULANG]** (menu language): Select a language for DVD root menu
 - **[DIVX LANG]** (DivX language): Select a subtitle language for DivX video.
- 4 Select an option, then press **OK**.
- 5 Press **SYSTEM MENU** to exit.

Select TV type

The TV format determines the aspect ratio of display according to the type of TV you have connected.

- 1 Press **SYSTEM MENU**.
- 2 Select **[SYSTEM SETUP]** (system setup) > **[TV TYPE]** (TV type), then press **▶▶**.
- 3 Select an option, then press **OK**.
 - **[4:3PS]**: For 4:3 screen TV: full-height display with the trimmed sides.
 - **[4:3LB]**: For 4:3 screen TV: wide-screen display with black bars on the top and bottom of the screen.
 - **[16:9]**: For wide-screen TV: display ratio 16:9.

Select TV system

Select the color system that matches the connected TV.

- 1 Press **SYSTEM MENU**.
- 2 Select **[SYSTEM SETUP]** (system setup) > **[TV SYSTEM]** (TV system), then press **▶▶**.
- 3 Select an option, then press **OK**.
 - **[NTSC]**: For TV with NTSC color system.
 - **[PAL]**: For TV with PAL color system.
 - **[AUTO]** (auto): For TV with multiple color systems.
- 4 Press **SYSTEM MENU** to exit.

Restrict DVD play

Some DVDs may have a parental level assigned to the complete disc or to certain scenes on the disc. You can set a playback permission level for the scenes with this setting.



Note

- VCD, SVCD, and CD have no level indication, so parental control function has no effect on those kind of discs. Some DVDs are not encoded with a rating though the movie rating may be printed on the Disc cover. The rating level features does not work for such discs.

- 1 Press **SYSTEM MENU**.
- 2 Select **[SYSTEM SETUP]** (system setup) > **[RATING]** (rating), then press **▶▶**.
- 3 Select an option, then press **OK**.
 - ↳ DVDs that are rated above the level you selected does not play unless you enter your four-digit password and choose a higher level rating.
 - ↳ **[1 KID SAFE]**
Suitable for children.
 - ↳ **[2 G]**
Recommended as acceptable for viewers of all ages.

↳ [3 PG]

Parental guidance suggested.

↳ [4 PG13]

Material is unsuitable for children under age 13. Parental guidance suggested.

↳ [5 PG-R], [6 R]

Recommended that parents restrict children under 17 from viewing or allow them to view only when supervised by a parent or adult guardian.

↳ [7 NC-17]

Not recommended for children under age 17.

↳ [8 ADULT]

Viewed only by adults due to graphic sexual scenes, violence, or language.

4 Press **SYSTEM MENU** to exit.

Change parental control password

You can set a password to restrict play of certain discs.

1 Press **SYSTEM MENU**.2 Select **[SYSTEM SETUP]** (system setup) > **[PASSWORD]** (password), then press **▶▶**.3 Enter a four-digit password with **Numeric keypad 0-9**, then press **OK**.4 Press **SYSTEM MENU** to exit.
 Note

- The default password (1234) remains valid even if a new password is set.

View DivX VOD registration code

DivX is a popular media technology created by DivX, Inc. DivX media files contain highly compressed video with high visual quality that maintains a relatively small file size. DivX files can also include advanced media features like menus, subtitles, and alternate audio tracks. Many DivX media files are available for download online, and you can rent and purchase DivX videos with the DivX VOD (Video on Demand) service. To use this service, you need the DivX VOD registration code of the unit. For more information and instructions, visit www.divx.com/vod.

1 Press **SYSTEM MENU**.2 Select **[SYSTEM SETUP]** (system setup) > **[DIVX[R] VOD]**, then press **▶▶**.3 Press **OK**.

↳ The registration code appears.

4 Write down the code for future use.

5 Press **SYSTEM MENU** to exit.
 Note

- All the downloaded videos from DivX® VOD can only be played on this unit.

Video settings

Adjust picture quality

During DVD play, you can adjust brightness, contrast, hue, and saturation to improve picture quality.

1 Press **SYSTEM MENU**.2 Select **[VIDEO SETUP]** (video setup).3 Select an option, then press **▶▶**.

- **[BRIGHTNESS]** (brightness): Adjust the brightness level.
- **[CONTRAST]** (contrast): Adjust the contrast level.
- **[HUE]** (hue): Adjust the hue level.
- **[SATURATION]** (saturation): Adjust the saturation level.

- 4 Press **▲▼** to adjust value, then press **OK**.
- 5 Press **SYSTEM MENU** to exit.

Audio settings

Select audio downmix

Select a suitable audio downmix when you are playing a DVD recorded in Dolby Digital format.

- 1 Press **SYSTEM MENU**.
- 2 Select **[AUDIO SETUP]** (audio setup) > **[DOWNMIX]** (downmix), then press **▶▶**.
- 3 Select an option, then press **OK**.
 - **[LT/RT]**: Select this if the unit is connected to a Dolby Pro Logic decoder.
 - **[STEREO]** (stereo): Select this when output delivers sound from only the two front speakers.
- 4 Press **SYSTEM MENU** to exit.

Select reverb mode

3D processing provides a virtual surround sound experience using just two speakers.

- 1 Press **SYSTEM MENU**.
- 2 Select **[AUDIO SETUP]** (audio setup) > **[3D PROCESSING]** (3d processing), then press **▶▶**.
- 3 Select an option, then press **OK**.
 - **[OFF]** (off),
 - **[CONCERT]** (concert)
 - **[CHURCH]** (church)
 - **[PASSIVE]** (passive)
 - **[WIDE]** (wide)
 - **[LIVE]** (live)
- 4 Press **SYSTEM MENU** to exit.

Select sampling rate

You can select the Linear Pulse Code Modulation (LPCM) output sampling rate. The higher the sampling rate, the better the sound quality.

- 1 Press **SYSTEM MENU**.
- 2 Select **[AUDIO SETUP]** (audio setup) > **[DOWN SAMPLE]** (down sample), then press **▶▶**.
- 3 Select an option, then press **OK**.
 - **[48K]**: For discs recorded at sampling rate of 48kHz.
 - **[96K]**: For discs recorded at sampling rate of 96 kHz.
 - **[192K]**: For discs recorded at sampling rate of 192 kHz.
- 4 Press **SYSTEM MENU** to exit.

Enable night mode

Night mode makes loud sound level softer so that you can watch the DVD movies at a low volume, without disturbing others.

- 1 Press **SYSTEM MENU**.
- 2 Select **[AUDIO SETUP]** (audio setup) > **[NIGHT MODE]** (night mode), then press **▶▶**.
- 3 Select an option, then press **OK**.
 - **[ON]** (on): Enjoy quiet viewing at night.
 - **[OFF]** (off): Enjoy surround sound with its full dynamic range.
- 4 Press **SYSTEM MENU** to exit.



9 Other features

Set the alarm timer

This unit can be used as an alarm clock. The DISC, USB or TUNER is activated to play at a preset time.

- 1 Ensure that you have set the clock correctly.
- 2 In standby mode, press and hold **TIMER**.
- 3 Press **DISC**, **TUNER** or **USB** to select a source.
- 4 Press **TIMER** to confirm.
 - ↳ The hour digits are displayed and begin to blink.
- 5 Press **◀▶** to set the hour.
- 6 Press **TIMER** to confirm.
 - ↳ The minute digits are displayed and begin to blink.
- 7 Press **◀▶** to set the minute.
- 8 Press **TIMER** to confirm.
 - ↳ The timer is set and activated.

Activate and deactivate alarm timer

- 1 Press **TIMER** repeatedly to activate or deactivate timer.
 - ↳ If timer is activated, the display shows .
 - ↳ If timer is deactivated,  disappears on the display.

Note

- Alarm timer is not available in MP3 LINK mode.
- If DISC/USB source is selected and the track cannot be played, tuner is activated automatically.

Set the sleep timer

This unit can switch to standby automatically after a set period of time.

- 1 When the unit is turned on, press **SLEEP** repeatedly to select a set period of time (in minutes).
 - ↳ When sleep timer is activated, the display shows **zZ**.

To deactivate sleep timer

- 1 Press **SLEEP** repeatedly until **[OFF]** is displayed.
 - ↳ When sleep timer is deactivated, **zZ** disappears on the display.

Listen to an external device

You can listen to an external device through this unit.

- 1 Press **MP3 Link** to select the MP3 link source.
- 2 Connect the supplied MP3 link cable to:
 - **MP3 Link** jack (3.5 mm) on the unit
 - the headphone jack on an external device.
- 3 Start to play the device (see the device user manual).

10 Product information

Note

- Product information is subject to change without prior notice.

Specifications

Amplifier

Rated output power	2 X 5 W RMS
Frequency response	60 - 16 kHz, ± 3 dB
Signal to noise ratio	>65 dB
Aux input	0.5 V RMS 20 kohm

Disc

Laser type	Semiconductor
Disc diameter	12 cm/8 cm
Video decoding	MPEG-2/MPEG-1
Video DAC	10 bits
Signal system	PAL/NTSC
Video format	4:3/16:9
Video S/N	56 dB (minimum)
Composite video output	1.0 Vp-p, 75 ohm
S-Video output	Y- 1.0 Vp-p, 75 ohm C- 0.286 Vp-p, 75 ohm
Audio DAC	24 bits / 96 kHz
Total harmonic distortion	<1%
Frequency response	4 Hz - 20 kHz (44.1kHz) 4 Hz - 22 kHz (48 kHz) 4 Hz - 44 kHz (96 kHz)
Total harmonic distortion	< 0.1% (1 kHz)
Channel separation	40 dB minimum (1 kHz)
S/N ratio	>65 dBA

FM

Tuning range	87.5 - 108 MHz
Tuning grid	50 kHz
Sensitivity	
- Mono, 26 dB S/N ratio	<22 dB
Total harmonic distortion	<3%
Signal to noise ratio	>55 dB

Speakers

Speaker Impedance	4ohm
Speaker Driver	3.5" woofer
Sensitivity	>82dB/m/W

General information

AC power	110 - 127/220-240 V, 50/60 Hz
Operation power consumption	20 W
Standby power consumption	< 4 W
USB direct	Version 2.0/1.1
Dimensions	
- Main unit (W x H x D)	150 x 152 x 250 mm
- Speaker box (W x H x D)	150 x 152 x 197 mm
Weight	
- With packing	5.30 kg
- Main unit	2.04 kg
- Speaker box	2 x 1.76 kg

USB playability information

Compatible USB devices:

- USB flash memory (USB 2.0 or USB 1.1)
- USB flash players (USB 2.0 or USB 1.1)
- memory cards (requires an additional card reader to work with this unit)

Supported formats:

- USB or memory file format FAT12, FAT16, FAT32 (sector size: 512 bytes)
- MP3 bit rate (data rate): 32-320 Kbps and variable bit rate
- WMA v9 or earlier
- Directory nesting up to a maximum of 8 levels
- Number of albums/ folders: maximum 99
- Number of tracks/titles: maximum 999
- ID3 tag v2.0 or later
- File name in Unicode UTF8 (maximum length: 128 bytes)

Unsupported formats:

- Empty albums: an empty album is an album that does not contain MP3/WMA files, and is not be shown in the display.
- Unsupported file formats are skipped. For example, Word documents (.doc) or MP3 files with extension .dlf are ignored and not played.
- AAC, WAV, PCM audio files
- DRM protected WMA files (.wav, .m4a, .m4p, .mp4, .aac)
- WMA files in Lossless format

Supported MP3 disc formats

- ISO9660, Joliet
- Maximum title number: 512 (depending on file name length)
- Maximum album number: 255
- Supported sampling frequencies: 32 kHz, 44.1kHz, 48 kHz
- Supported Bit-rates: 32~256 (kbps), variable bit rates

11 Troubleshooting



Warning

- Never remove the casing of this apparatus.

To keep the warranty valid, never try to repair the system yourself.

If you encounter problems when using this apparatus, check the following points before requesting service. If the problem remains unsolved, go to the Philips web site (www.philips.com/welcome). When you contact Philips, ensure that the apparatus is nearby and the model number and serial number are available.

No power

- Ensure that the AC power plug of the unit is connected properly.
- Ensure that there is power at the AC outlet.
- As a power-saving feature, the unit switches off automatically 15 minutes after track play reaches the end and no control is operated.

No sound or poor sound

No sound or poor sound

- Adjust the volume.
- Disconnect the headphones.
- Check that the speakers are connected correctly.
- Check if the stripped speaker wires are clamped.

Left and right sound outputs reversed

- Check the speaker connections and location.

No response from the apparatus

- Disconnect and reconnect the AC power plug, then turn on the system again.

- As a power-saving feature, the system switches off automatically 15 minutes after track play reaches the end and no control is operated.

Remote control does not work

- Before you press any function button, first select the correct source with the remote control instead of the main unit.
- Reduce the distance between the remote control and the unit.
- Insert the battery with its polarities (+/- signs) aligned as indicated.
- Replace the battery.
- Aim the remote control directly at the sensor on the front of the unit.

No disc detected

- Insert a disc.
- Check if the disc is inserted upside down.
- Wait until the moisture condensation at the lens has cleared.
- Replace or clean the disc.
- Use a finalized CD or correct format disc.

No picture

- Check the video connection.
- Turn on the TV to the correct Video-In channel.

Audio or subtitle languages cannot be set

- The disc is not recorded with sound or subtitles in multiple languages.
- The audio or subtitle language setting is prohibited on the disc.

Cannot display some files in USB device

- The number of folders or files in the USB device has exceeded a certain limit. This phenomenon is not a malfunction.
- The formats of these files are not supported.

USB device not supported

- The USB device is incompatible with the unit. Try another one.

Poor radio reception

- Increase the distance between the unit and your TV or VCR.
- Fully extend the FM antenna.

Timer does not work

- Set the clock correctly.
- Switch on the timer.

Clock/timer setting erased

- Power has been interrupted or the power cord has been disconnected.
- Reset the clock/timer.

12 Glossary

A

Analog audio

Sound that has not been turned into numbers. Analog sound is available when you use the AUDIO LEFT/RIGHT. These red and white jacks send audio through two channels, the left and right.

Aspect ratio

Aspect ratio refers to the length to height ratio of TV screens. The ratio of a standard TV is 4:3, while the ratio of a high-definition or wide TV is 16:9. The letter box allows you to enjoy a picture with a wider perspective on a standard 4:3 screen.

AUDIO OUT sockets

Red and white sockets that send audio to another system (TV, Stereo, etc).

B

Bit rate

Bit rate is the number of bits that are conveyed or processed per unit of time. The bit rate is usually measured in some multiple of bits per second (kilobits per second: kbps). The term bit rate is a synonym for data transfer rate (or simply data rate).

C

Chapter

Chapter
Sections of a picture or a music piece on a DVD that are smaller than titles. A title is composed of several chapters. Each chapter is assigned a chapter number that enables you to locate a specific chapter.

D

Digital Audio

Digital Audio is a sound signal that has been converted into numerical values. Digital sound can be transmitted through multiple channels. Analog sound can only be transmitted through two channels.

Disc menu

A screen display that allows election of images, sounds, subtitles, multi-angles, etc., recorded on a DVD.

DivX®

The DivX® codec is a patent-pending, MPEG-4 based video compression technology developed by DivX®, Inc. It can shrink the file size of digital video and still maintain the high visual quality.

Dolby Digital

A surround sound system developed by Dolby Laboratories that contains up to six channels of digital audio (front left and right, surround left and right, center and subwoofer).

J

JPEG

A very common digital still picture format. A still-picture data compression system proposed by the Joint Photographic Expert Group, which features small decrease in image quality in spite of its high compression ratio. Files are recognized by their file extension '.jpg' or '.jpeg.'

M

MP3

A file format with a sound data compression system. MP3 is the abbreviation of Motion Picture Experts Group 1 (or MPEG-1) Audio Layer 3. With the MP3 format, one CD-R or CD-RW can contain about 10 times more data than a regular CD.

Multichannel

Usually DVD is specified to have each sound track constitute one sound field. Multichannel refers to a structure of sound tracks having three or more channels.

P

Parental control

A function of the DVD to limit playback of the disc by the age of the users according to the limitation level in each country. The limitation varies from disc to disc; when it is activated, playback will be prohibited if the software's level is higher than the user-set level.

PBC

Playback Control. A system where you navigate through a Video CD/Super VCD with on-screen menus that are recorded onto the disc. You can enjoy interactive playback and search.

PCM

Pulse Code Modulation. A digital audio encoding system.

R

Region code

A system that allows discs to be played only in the region designated. This unit only plays discs that have compatible region codes. You can find the region code of your unit on the product label. Some discs are compatible with more than one region (or ALL regions.)

S

S-Video

An analog video connection. It is capable of transmitting clear picture quality by sending separate signals for luminance and colour to the connected device. You can use S-Video only if your TV has an S-Video In socket.

Surround

A system that creates realistic, three-dimensional sound fields. It is usually achieved with multiple speakers that are arranged around the listener.

T

Title

On commercial DVDs, this is the longest section of a movie or music feature on DVD. Each title is assigned a title number, so that you can locate the title you want.

When you record programs, they are stored as titles. Depending on the recording settings, recorded titles may automatically contain several chapters.

V

VIDEO OUT socket

Yellow socket that sends the DVD picture video to a TV.

