

# Micro Hi-Fi System

MC235

user manual  
manuel d'utilisation  
manual del usuario



## **Read this manual first!**

*Congratulations on purchasing this Philips product. We've included everything you need to get started. If you have any problems, Philips Representatives can help you get the most from your new product by explaining:*

- Hookups,
- First Time Setup, and
- Feature Operation.

*Do not attempt to return this product to the store.*

**For fast help, call us first!**

**1-800-531-0039**

*Thank you for making Philips a part of your home!*



# PHILIPS

## Canada

### English:

This digital apparatus does not exceed the Class B limits for radio noise emissions from digital apparatus as set out in the Radio Interference Regulations of the Canadian Department of Communications.

### Français:

Cet appareil numérique n'émet pas de bruits radioélectriques dépassant les limites applicables aux appareils numériques de Class B prescrites dans le Règlement sur le Brouillage Radioélectrique édicté par le Ministère des Communications du Canada.

**This warning label is located on the rearside and inside this laser product.**

**CAUTION:** INVISIBLE LASER RADIATION WHEN OPEN. DO NOT STARE INTO BEAM.

**DANGER:** INVISIBLE LASER RADIATION WHEN OPEN. AVOID DIRECT EXPOSURE TO BEAM.

**VARO!** AVATTAESSA JA SUOJALLUKITUS OHITETTAESSA OLET ALTTIINANÄKYMÄTTÖMÄALLE LASERSATEILYLLE. ÄLÄ KATSO SATEESEEN.

**WARNING!** OSYNLIG LASERSTRÅLNING NÄR DENNA DEL ÄR ÖPPNAD. OCH SPÄRREN ÄR URKOPPLAD. BETRÄKTA EJ STRÅLEN.

or

**DANGER** - Invisible laser radiation when open. AVOID DIRECT EXPOSURE TO BEAM.

## CAUTION

**Use of controls or adjustments or performance of procedures other than herein may result in hazardous radiation exposure or other unsafe operation.**

## ATTENTION

**L'utilisation des commandes ou réglages ou le non-respect des procédures ci-incluses peuvent se traduire par une exposition dangereuse à l'irradiation.**

## ATENCIÓN

**El uso de mando o ajustes o la ejecución de métodos que no sean los aquí descritos puede ocasionar peligro de exposición a radiación.**

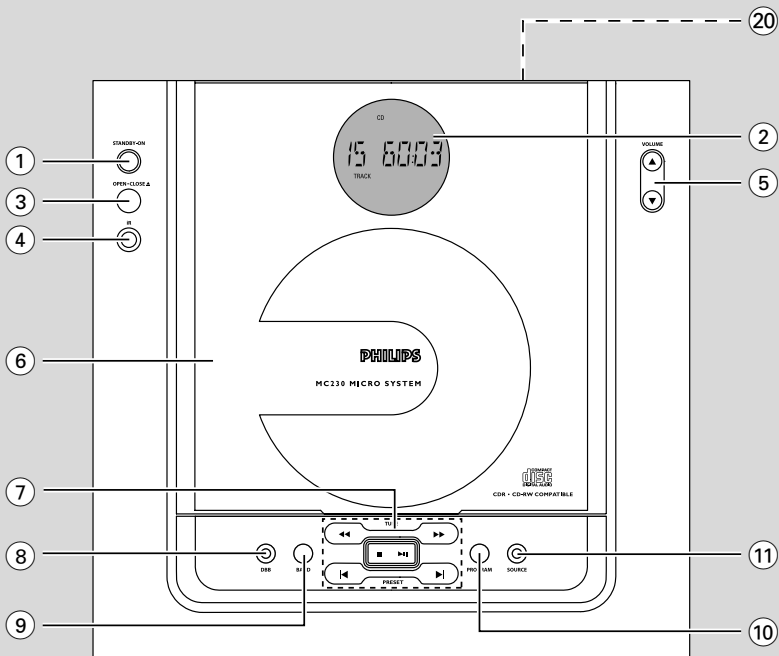
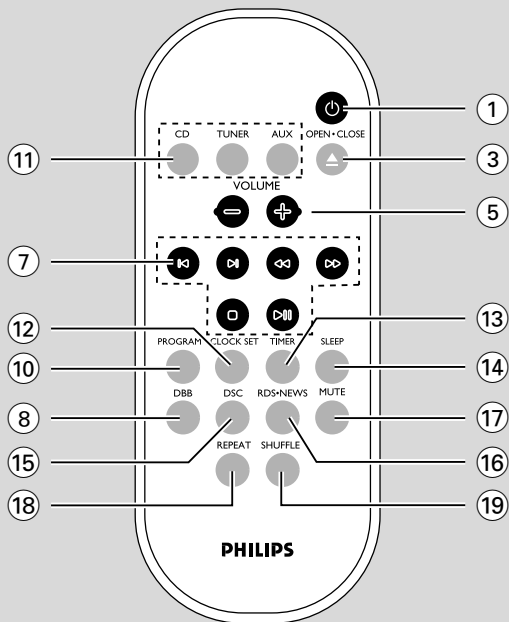

# Return your Warranty Registration card today to ensure you receive all the benefits you're entitled to.

- Once your Philips purchase is registered, you're eligible to receive all the privileges of owning a Philips product.
- So complete and return the Warranty Registration Card enclosed with your purchase at once, and take advantage of these important benefits.

## Warranty Verification

Registering your product within 10 days confirms your right to maximum protection under the terms and conditions of your Philips warranty.

## Owner Confirmation

Your completed Warranty Registration Card serves as verification of ownership in the event of product theft or loss.

## Model Registration

Returning your Warranty Registration Card right away guarantees you'll receive all the information and special offers which you qualify for as the owner of your model.

Know these *safety* symbols



 This “bolt of lightning” indicates uninsulated material within your unit may cause an electrical shock. For the safety of everyone in your household, please do not remove product covering.

 The “exclamation point” calls attention to features for which you should read the enclosed literature closely to prevent operating and maintenance problems.

### For Customer Use

Enter below the Serial No. which is located on the rear of the cabinet. Retain this information for future reference.

Model No. \_\_\_\_\_

Serial No. \_\_\_\_\_

**WARNING:** TO PREVENT FIRE OR SHOCK HAZARD, DO NOT EXPOSE THIS EQUIPMENT TO RAIN OR MOISTURE.

**CAUTION:** To prevent electric shock, match wide blade of plug to wide slot, and fully insert.



# PHILIPS



***Congratulations on your purchase,  
and welcome to the “family!”***

**Dear Philips product owner:**

Thank you for your confidence in Philips. You've selected one of the best-built, best-backed products available today. And we'll do everything in our power to keep you happy with your purchase for many years to come.

As a member of the Philips “family,” you're entitled to protection by one of the most comprehensive warranties and outstanding service networks in the industry.

What's more, your purchase guarantees you'll receive all the information and special offers for which you qualify, plus easy access to accessories from our convenient home shopping network.

And most importantly you can count on our uncompromising commitment to your total satisfaction.

All of this is our way of saying welcome – and thanks for investing in a Philips product.

**P.S. Remember, to get the most from your Philips product, you must return your Warranty Registration Card within 10 days. So please mail it to us right now!**

# IMPORTANT SAFETY INSTRUCTIONS

1. **Read these instructions.**
2. **Keep these instructions.**
3. **Heed all warnings.**
4. **Follow all instructions.**
5. **Do not use this apparatus near water.**
6. **Clean only with dry cloth.**
7. **Do not block any ventilation openings. Install in accordance with the manufacturer's instructions.**
8. **Do not install near any heat sources** such as radiators, heat registers, stoves, or other apparatus (including amplifiers) that produce heat.
9. **Do not defeat the safety purpose** of the polarized or grounding-type plug. A polarized plug has two blades with one wider than the other. A grounding type plug has two blades and a third grounding prong. The wide blade or the third prong are provided for your safety. If the provided plug does not fit into your outlet, consult an electrician for replacement of the obsolete outlet.

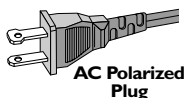

10. **Protect the power cord** from being walked on or pinched, particularly at plugs, convenience receptacles, and the point where they exit from the apparatus.
11. **Only use attachments/ accessories** specified by the manufacturer:

12.  **Use only with the cart**, stand, tripod, bracket, or table specified by the manufacturer or sold with the apparatus. When a cart is used, use caution when moving the cart/ apparatus combination to avoid injury from tip-over.

13. **Unplug this apparatus** during lightning storms or when unused for long periods of time.
14. **Refer all servicing** to qualified service personnel. Servicing is required when the apparatus has been damaged in any way, such as power-supply cord or plug is damaged, liquid has been spilled or objects have fallen into the apparatus, the apparatus has been exposed to rain or moisture, does not operate normally, or has been dropped.

15. **Battery usage CAUTION** – To prevent battery leakage which may result in bodily injury, property damage, or damage to the unit:
  - Install **all** batteries correctly, **+** and **-** as marked on the unit.
  - Do not mix batteries (**old** and **new** or **carbon** and **alkaline**, etc.).
  - Remove batteries when the unit is not used for a long time.

16. **Apparatus shall not be exposed to dripping or splashing.**
17. **Do not place any sources of danger on the apparatus.** (e.g. liquid filled objects, lighted candles).

18. This product may contain lead and mercury. Disposal of these materials may be regulated due to environmental considerations. **For disposal or recycling information, please contact your local authorities or the Electronic Industries Alliance: [www.eiae.org](http://www.eiae.org).**

**Class II equipment symbol**   
This symbol indicates that the unit has a double insulation system

English ..... 8

Français ..... 21

Español ..... 38

English

Français

Español

---

## General Information

|                                 |   |
|---------------------------------|---|
| Environmental information ..... | 9 |
| Supplied accessories .....      | 9 |
| Safety information .....        | 9 |

---

## Preparations

|  |       |
|--|-------|
| Rear connections .....   | 10–11 |
| Optional connection .....  | 11    |
| Before using the remote control .....                            | 11    |
| Replacing battery (lithium CR2025) into the remote control ..... | 11    |

---

## Controls

|   |    |
|---|----|
| Controls on the system and remote control ..... | 12 |
|---|----|

---

## Basic Functions

|                                      |    |
|--------------------------------------|----|
| Switching the system on .....        | 13 |
| Power-saving automatic standby ..... | 13 |
| Adjusting volume and sound .....     | 13 |

---

## CD Operation

|  |    |
|--|----|
| Playing a disc .....                           | 14 |
| Selecting a different track .....              | 14 |
| Finding a passage within a track .....         | 14 |
| Different play modes: Shuffle and Repeat ..... | 15 |
| Programming track numbers .....                | 15 |
| Reviewing the programme .....                  | 15 |
| Erasing the programme .....                    | 15 |

---

## Radio Reception

|                                       |    |
|---------------------------------------|----|
| Tuning to radio stations .....        | 16 |
| Programming radio stations .....      | 16 |
| Tuning to preset radio stations ..... | 16 |

---

## Clock/Timer

|   |    |
|---|----|
| Setting the clock .....                 | 17 |
| Viewing the clock .....                 | 17 |
| Setting the timer .....                 | 17 |
| Activating and deactivating TIMER ..... | 17 |
| Activating and deactivating SLEEP ..... | 17 |

---

## Specifications .....

---

## Maintenance .....

---

## Troubleshooting .....



***This system complies with the FCC rules, Part 15 and with 21 CFR 1040. 10.***

***Operation is subject to the following two conditions:***

- ***This device may not cause harmful interference, and***
- ***this device must accept any interference received, including interference that may cause undesired operation.***

## Environmental Information

All unnecessary packaging has been omitted. We have tried to make the packaging easy to separate into three materials: cardboard (box), polystyrene foam (buffer) and polyethylene (bags, protective foam sheet).

Your system consists of materials which can be recycled and reused if disassembled by a specialized company. Please observe the local regulations regarding the disposal of packaging materials, exhausted batteries and old equipment.

## Supplied accessories

- 2 speaker boxes
- remote control (with battery)
- AM loop antenna
- FM wire antenna
- stand
- screw and plug assembly

## Safety Information

- Before operating the system, check that the operating voltage indicated on the typeplate (or the voltage indication beside the voltage selector) of your system is identical with the voltage of your local power supply. If not, please consult your dealer.
- Place the system on a flat, hard and stable surface.
- Place the system in a location with adequate ventilation to prevent internal heat build-up in your system. Allow at least 10 cm (4 inches) clearance from the rear and the top of the unit and 5 cm (2 inches) from each side.
- The ventilation should not be impeded by covering the ventilation openings with items, such as newspapers, table-cloths, curtains, etc.
- Do not expose the system, batteries or discs to excessive moisture, rain, sand or heat sources caused by heating equipment or direct sunlight.
- No naked flame sources, such as lighted candles, should be placed on the apparatus.
- No objects filled with liquids, such as vases, shall be placed on the apparatus.
- If the system is brought directly from a cold to a warm location, or is placed in a very damp room, moisture may condense on the lens of the disc unit inside the system. Should this occur, the CD player would not operate normally. Leave the power on for about one hour with no disc in the system until normal playback is possible.
- The mechanical parts of the set contain self-lubricating bearings and must not be oiled or lubricated.
- **When the system is switched to Standby mode, it is still consuming some power. To disconnect the system from the power supply completely, remove the AC power plug from the wall socket.**

# Preparations

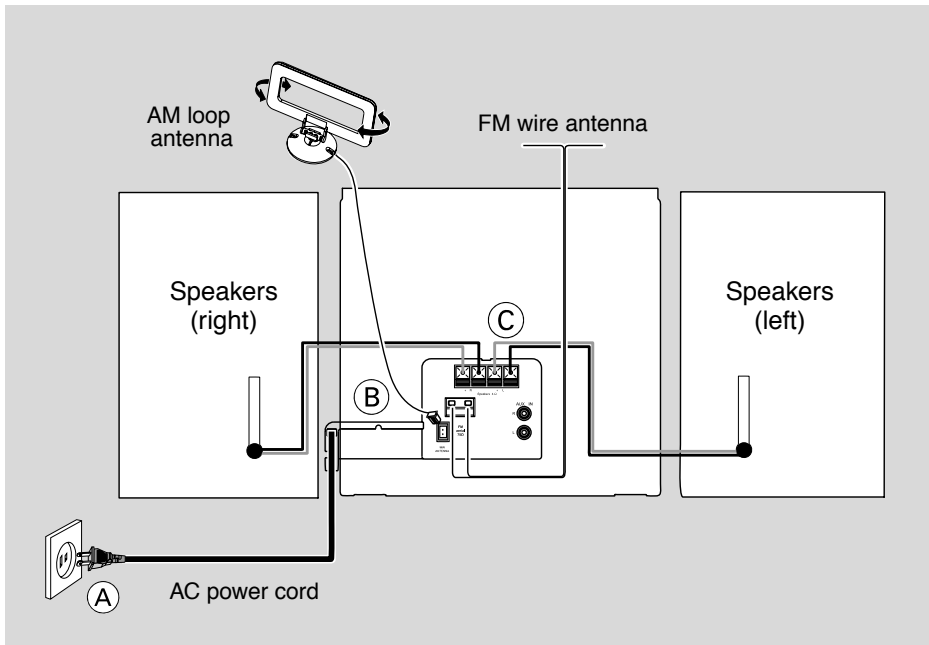

## Rear connections

The type plate is located at the rear of the system.

### A Power

Before connecting the AC power cord to the wall outlet, ensure that all other connections have been made.

#### WARNING!

- For optimal performance, use only the original power cable.
- Never make or change any connections with the power switched on.

To avoid overheating of the system, a safety circuit has been built in. Therefore, your system may switch to Standby mode automatically under extreme conditions. If this happens, let the system cool down before reusing it (not available for all versions).

### B Antennas Connection

Connect the supplied AM loop antenna and FM antenna to the respective terminals. Adjust the position of the antenna for optimal reception.

#### AM Antenna

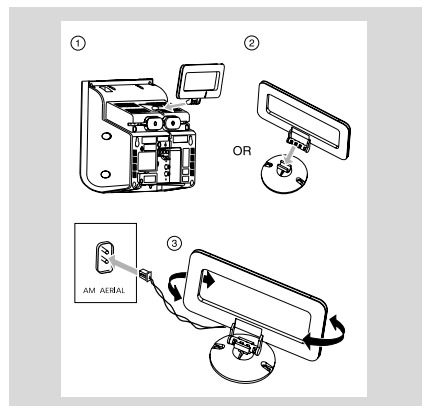

- Position the antenna as far as possible from a TV, VCR or other radiation source.

## FM Antenna

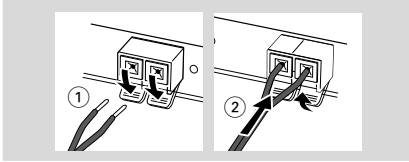

- For better FM stereo reception, connect an outdoor FM antenna to the FM AERIAL (FM ANTENNA) terminal.

## C Speakers Connection

### Front Speakers

Connect the speaker wires to the SPEAKERS terminals, right speaker to "RIGHT" and left speaker to "LEFT", coloured (marked) wire to "+" and black (unmarked) wire to "-".

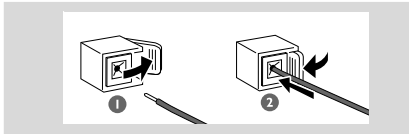

- Fully insert the stripped portion of the speaker wire into the terminal as shown.

### Notes:

- For optimal sound performance, use the supplied speakers.
- Do not connect more than one speaker to any one pair of +/– speaker terminals.
- Do not connect speakers with an impedance lower than the speakers supplied. Please refer to the SPECIFICATIONS section of this manual.

## Optional connection

The optional equipment and connecting cords are not supplied. Refer to the operating instructions of the connected equipment for details.

### Connecting other equipment to your system

Connect the audio left and right OUT terminals of a TV, VCR, Laser Disc player, DVD player or CD Recorder to the **AUX-IN** terminals.

### Note:

- If you are connecting equipment with a mono output (a single audio out terminal), connect it to the AUX IN left terminal. Alternatively, you can use a "single to double" cinch cable (the output sound still remain mono).

## Before using the remote control

- 1 Pull out the plastic protective sheet.
- 2 Select the source you wish to control by pressing one of the source select keys on the remote control (for example CD, TUNER).
- 3 Then select the desired function (for example **▶▶**, **◀◀**, **▶|**).

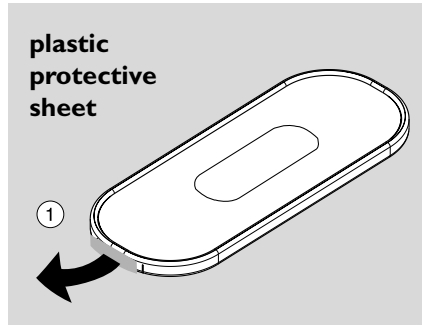

## Replacing battery (lithium CR2025) into the remote control

- 1 Pull out the knob (A) slightly to the left.
- 2 Pull out the battery compartment (B).
- 3 Replace a new battery and fully insert the battery compartment back to the original position.

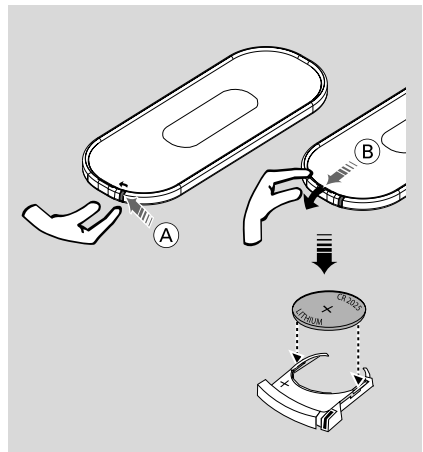

### CAUTION!

**Batteries contain chemical substances, so they should be disposed off properly.**

# Controls (illustrations on page 3)

## Controls on the system and remote control

### ① STANDBY-ON

- switches the system on or to standby.

### ② Display

- shows the status of the system.

### ③ OPEN • CLOSE ▲

- opens/ closes the CD door.

### ④ IR

- remote sensor

### ⑤ VOLUME (▲ / ▼) (+ / -)

- adjusts the volume level.

### ⑥ CD Door

### ⑦ Mode Selection

#### SEARCH/TUNE (◀ / ▶)

for TUNER .....tunes to a station

for CD ..... fast searches back and forward within a track/ CD.

**STOP ■** ..... stops CD playback or erases a CD programme.

**PLAY ▶▶** ..... starts or interrupts playback.

#### PRESET (◀ / ▶)

for TUNER .....selects a preset radio station.

for CD .....skips to the beginning of a current track/ previous/ subsequent track

### ⑧ DBB (Dynamic Bass Boost)

- enhances the bass.

### ⑨ BAND

- selects a waveband.

### ⑩ PROGRAM

for CD ..... programmes tracks and reviews the programme.

for TUNER ..... programmes tuner stations.

### ⑪ SOURCE

- selects the respective sound source for CD/ TUNER/ AUX.

### ⑫ CLOCK SET

- sets the clock function.
- views the clock.

### ⑬ TIMER

- activates/deactivates or sets the timer function.

### ⑭ SLEEP

- activates/deactivates or selects the sleeper time.

### ⑮ DSC (Digital Sound Control)

- selects sound characteristics: ROCK/ JAZZ/ POP/ CLASSIC.

### ⑯ RDS.NEWS

- activates RDS news and Traffic Announcement (not for all versions).

### ⑰ MUTE

- interrupts and resumes sound reproduction.

### ⑱ REPEAT

- repeats a track/ CD programme/ entire CD.

### ⑲ SHUFFLE

- plays CD tracks in random order.

### ⑳

- connects headphones

#### Notes for remote control:

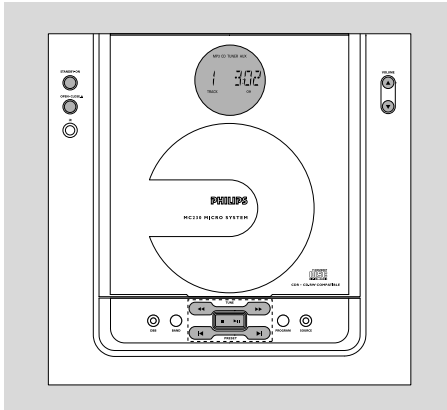

- First select the source you wish to control by pressing one of the source select keys on the remote control (for example CD, TUNER).
- Then select the desired function (for example ▶▶, ◀, ▶).



## IMPORTANT!

**Before you operate the system, complete the preparation procedures.**

## Switching the system on

- Press **STANDBY-ON** / .
  - The system will switch to the last selected source.
- Press **SOURCE** (or **CD**, **TUNER** or **AUX** on the remote control).
  - The system will switch to the selected source.
- Press **OPEN • CLOSE** .



### To switch the system to standby mode

- Press **STANDBY-ON** / .
  - The backlight for clock display is dim in standby.
- The volume level (up to a maximum volume level of 20), interactive sound settings, last selected mode, source and tuner presets will be retained in the player's memory.

## Power-saving automatic standby

As a power-saving feature, the system automatically switches to standby 15 minutes after a CD has reached the end and no control is operated.

## Adjusting volume and sound

- 1 Press the **VOLUME**  /  (**+/-**) control to decrease or increase the volume.
    - Display shows the volume level  and a number from MIN1, 2, ...30, 31 MAX.
  - 2 Press **DSC** repeatedly to select the desired sound effect: **ROCK** / **JAZZ** / **POP** / **CLASSIC**.
  - 3 Press **DBB** to switch bass enhancement on or off.
    - Display shows: DBB.
  - 4 Press **MUTE** on the remote control to interrupt sound reproduction instantly.
    - Playback will continue without sound and the display shows **MUTE**.
- To activate sound reproduction you can:
    - press **MUTE** again;
    - adjust the volume controls;
    - change source.

# CD Operation

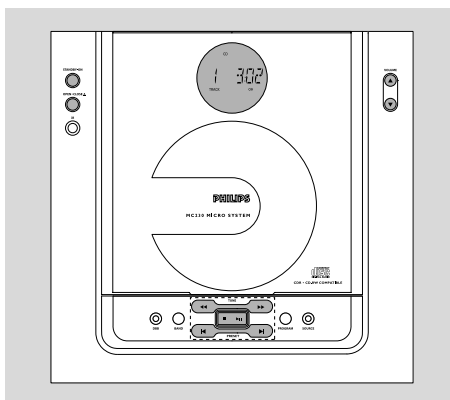

## IMPORTANT!

*The lens of the CD player should never be touched.*

## Playing a disc

This CD player plays Audio Discs including CD-Recordables and CD-Rewritables.

- CD-ROM, CD-I, CDV, VCD, MP3, DVD or computer CDs, however, are not possible.

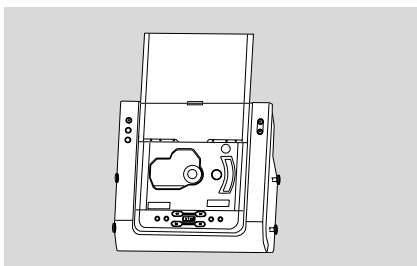

- 1 Press **SOURCE** to select CD.
- 2 Press **OPEN • CLOSE** ▲ on the front panel of the system to open the CD compartment.  
→ **OPEN** is displayed when the compartment cover slides up.
- 3 Insert a disc with the printed side facing up. Press **OPEN • CLOSE** ▲ again to close the compartment.  
→ **READING** is displayed as the CD player scans the contents of the disc.  
→ The total playing time and the total number of tracks are displayed.

- 4 Press **▶||** to start playback.  
→ Current track number and elapsed playing time of the track are displayed during disc playback.
- 5 To interrupt playback press **▶||**. Press **▶||** again to resume play.
- 6 To stop disc playback, press **STOP** ■.

*Note: CD play will also stop when;*

– *the CD door is opened.*

– *the disc has reached the end.*

– *you select another source: TUNER, AUX or standby.*

## Selecting a different track

- Press **◀** or **▶** once or repeatedly until the desired track number appears in the display.
- If you have selected a track number shortly after loading a disc or in the PAUSE position, you will need to press **▶||** to start playback.

## Finding a passage within a track

- 1 Press and hold **◀◀** or **▶▶**.  
→ The disc is played at high speed and low volume.
- 2 When you recognise the passage you want, release **◀◀** or **▶▶**.  
→ Normal playback continues.

## Different play modes: SHUFFLE and REPEAT

You can select and change the various play modes before or during playback. The play modes can also be combined with PROGRAMME.

**SHUFFLE** ..... tracks of the entire disc/ programme are played in random order

**SHUFFLE** and **REPEAT ALL** ... to repeat the entire disc/ programme continuously in random order

**REPEAT ALL** ... repeats the entire disc/ programme

**REPEAT** ..... plays the current track continuously

- 1 To select your play mode, press the **SHUFFLE** or **REPEAT** button before or during playback until the display shows the desired function.
  - 2 Press **▶||** to start playback if in the STOP position.  
→ If you have selected SHUFFLE, playback starts automatically.
  - 3 To return to normal playback, press the respective **SHUFFLE** or **REPEAT** button until the various SHUFFLE/ REPEAT modes are no longer displayed.
- You can also press **STOP ■** to cancel your play mode.

## Programming track numbers

Programme in the STOP position to select and store your disc tracks in the desired sequence. If you like, store any track more than once. Up to 40 tracks can be stored in the memory.

- 1 Press **PROGRAM** to enter the programming mode.  
→ A track number is shown and **PROGRAM** flashes.
- 2 Use the **◀** or **▶** to select your desired track number.
- 3 Press **PROGRAM** to confirm the track number to be stored.

→ The number of tracks programmed and the total playing time of the programme are shown briefly, then the selected track and *PRG*.

- 4 Repeat steps 2-3 to select and store all desired tracks.  
→ *FULL* is displayed if you attempt to programme more than 40 tracks.
- 5 To start playback of your disc program, press **STOP ■** followed by **▶||** or press **▶||** directly.

## Reviewing the programme

In **STOP** mode, press and hold down **PROGRAM** for a while until the display shows all your stored track numbers in sequence.

## Erasing the programme

You can erase the programme by:

- pressing **STOP ■** once in the STOP mode;
- pressing **STOP ■** twice during playback;
- opening the CD compartment;  
→ **PROGRAM** disappears.  
→ *CLERR* scrolls and then disappears from the display.

# Radio Reception

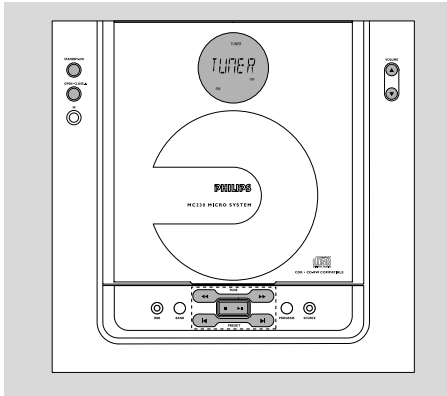

## Tuning to radio stations

- 1 Press **SOURCE** to select TUNER.  
→ **TUNER** is displayed briefly.
  - 2 Press **BAND** (or **TUNER** on the remote control) once or more to select your waveband. (FM/AM)
  - 3 Press and hold **TUNE** ◀◀ or ▶▶.  
→ The radio automatically tunes to a station with sufficient reception. Display indication during automatic tuning: **SEARCH**.
  - 4 Repeat step 3 if necessary until you find the desired station.
- To tune to a weak station, press **TUNE** ◀◀ or ▶▶ briefly and repeatedly until you have found optimal reception.

## Programming radio stations

You can store up to a total of 40 radio stations in the memory.

### Automatic programming

Automatic programming will start with a chosen preset number. From this preset number upwards, former programmed radio stations will be overridden. The system will only program stations which are not in the memory already.

- 1 Press **PRESET** ◀ or ▶ to select the preset number where programming should start.

**Note:**

– If no preset number is selected, default is preset (1) and all your presets will be overridden.

- 2 Press **PROGRAM** for more than 2 seconds to activate programming.  
→ **AUTO** is displayed and available stations are programmed in order of waveband reception strength: FM followed by AM. The last preset automatically stored will then be played.

### Manual programming

- 1 Tune to your desired station (see Tuning to radio stations).
  - 2 Press **PROGRAM** to activate programming.  
→ **PROGRAM** flashes in the display.
  - 3 Press **PRESET** ◀ or ▶ to allocate a number from 1 to 40 to this station.
  - 4 Press **PROGRAM** again to confirm the setting.  
→ **PROGRAM** disappears, the preset number and the frequency of the preset station are shown.
  - 5 Repeat the above four steps to store other stations.
- You can override a preset station by storing another frequency in its place.

### Tuning to preset radio stations

- Press **PRESET** ◀ or ▶ until the desired preset station is displayed.



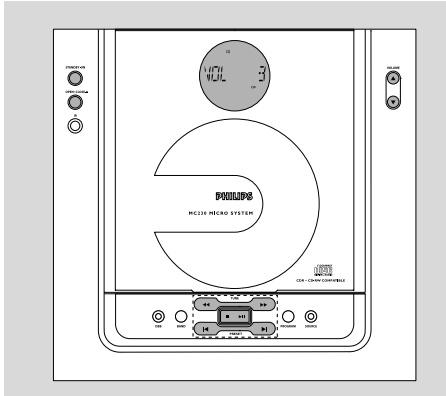

## Setting the clock

- 1 In standby mode or system on, press and hold **CLOCK SET** on the remote control for more than 3 seconds.  
→ **SET CLOCK** scrolls on the display.  
→ The clock digits for the hours flash.
- 2 Press **VOLUME +/-** to set the hours.
- 3 Press **CLOCK SET** again.  
→ The clock digits for the minutes flash.
- 4 Press **VOLUME +/-** to set the minutes.
- 5 Press **CLOCK SET** to confirm the time.

**Note:**

– The backlight for clock display is dim in standby.

## Viewing the clock

Press **SET CLOCK**.

→ The clock time is displayed.

## Setting the timer

- The system can be used as an alarm clock, whereby the CD,TUNER is switched on at a set time. The clock time needs to be set first before the timer can be used.
  - During setting, if no button is pressed within 90 seconds, the system will exit timer setting mode automatically.
- 1 In standby mode or system on, press and hold **TIMER** on the remote control for more than 3 seconds.  
→ **SET TIMER** and **SELECT SOURCE** scrolls on the display.

- 2 Press **SOURCE** or **VOLUME +/-** to select sound source.  
→ Display sequence shows **CD, TUNER**.  
→  flashes.
- 3 Press **TIMER** to confirm your desired mode.
- 4 Press **VOLUME +/-** to set the hours.
- 5 Press **TIMER** again.  
→ The clock digits for the minutes flash.
- 6 Press **VOLUME +/-** to set the minutes.
- 7 Press **TIMER** to confirm the time.  
→ The timer is now set and activated.

## Activating and deactivating TIMER

- Press **TIMER** on the remote to turn off the timer or turn on to the last setting again.  
→ If activated, the timer information will display for a few seconds, then the system resumes to the last active source or stays in standby mode.  
→ If deactivated, "OFF" appears.

**Note:**

– The system will exit timer setting mode if no button is pressed within 90 seconds.

## Activating and deactivating SLEEP

The sleep timer enables the system to switch off by itself after a set period of time. The clock time needs to be set first before the sleep timer can be used.

- Press **SLEEP** on the remote control once or more.  
→ Display shows **SLEEP** and one of the sleep time options in sequence: **90, 75, 60, ..., 45, 30, 15, OFF, 90**. If you have selected a time. Once **SLEEP** is activated, **SLEEP** scrolls across the display at repeated intervals.
- To deactivate, press **SLEEP** on the remote control once or more until **OFF** is shown, or press **STANDBY-ON** on the system or remote control.  
→ **OFF** is displayed.

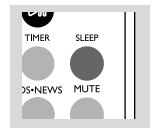

# Specifications

## AMPLIFIER

Output power ..... 20W total power  
..... 2 x 5 W RMS  
..... 2 x 4 W FTC<sup>(1)</sup>  
Signal-to-noise ratio .....  $\geq 65$  dBA (IEC)  
Frequency response ..... 40 – 20000 Hz,  $\pm 3$  dB  
Input sensitivity AUX ..... 0.5V (max. 2V)  
Impedance loudspeakers ..... 4  $\Omega$   
Impedance headphones ..... 32  $\Omega$  -1000  $\Omega$   
(1) (4 $\Omega$ , 60Hz - 12.5Hz, 10%THD)

## CD PLAYER

Frequency range ..... 20 – 20000 Hz  
Signal-to-noise ratio ..... 75 dBA

## TUNER

FM wave range ..... 87,5 – 108 MHz  
AM wave range ..... 530 – 1700 kHz  
Sensitivity at 300  $\Omega$   
– mono, 26 dB signal-to-noise ratio ..... 2.8  $\mu$ V  
– stereo, 46 dB signal-to-noise ratio ..... 61.4  $\mu$ V  
Selectivity .....  $\geq 28$  dB  
Total harmonic distortion .....  $\leq 5\%$   
Frequency response ..... 63 – 12500 Hz ( $\pm 3$  dB)  
Signal-to-noise-ratio .....  $\geq 50$  dBA

## SPEAKERS

Bass reflex system  
Dimensions (w x h x d) .... 166 x 245 x 90 (mm)  
..... 6.54 x 9.65 x 3.54 (inch)

## GENERAL INFORMATION

AC Power Voltage ..... 120V / 60 Hz  
Dimensions (w x h x d) ..... 250 x 245 x 96 (mm)  
..... 9.84 x 9.65 x 3.78 (inch)  
Weight (with/without speakers) .....  
..... approx. 6.7 / 3.0 kg  
..... approx. 14.8 / 6.62 pound  
Standby power consumption ..... < 3W

## Subject to modification

# Maintenance

## Cleaning the Cabinet

- Use a soft cloth slightly moistened with a mild detergent solution. Do not use a solution containing alcohol, spirits, ammonia or abrasives.

## Cleaning Discs

- When a disc becomes dirty, clean it with a cleaning cloth. Wipe the disc from the center out.
- Do not use solvents such as benzene, thinner, commercially available cleaners, or antistatic spray intended for analog records.



## Cleaning the disc lens

- After prolonged use, dirt or dust may accumulate at the disc lens. To ensure good playback quality, clean the disc lens with Philips CD Lens Cleaner or any commercially available cleaner. Follow the instructions supplied with cleaner.

## WARNING

*Under no circumstances should you try to repair the system yourself, as this will invalidate the warranty. Do not open the system as there is a risk of electric shock.*

*If a fault occurs, first check the points listed below before taking the system for repair. If you are unable to remedy a problem by following these hints, consult your dealer or Philips for help.*

| Problem  | Solution  |
|--|---|
| <b>CD OPERATION</b>  |   |
| <b>"NO DISC" is displayed.</b>                             | <ul style="list-style-type: none"> <li>– Insert a disc.</li> <li>– Check if the disc is inserted upside down.</li> <li>– Wait until the moisture condensation at the lens has cleared.</li> <li>– Replace or clean the disc, see "Maintenance".</li> <li>– Use a finalised CD-RW or CD-R.</li> </ul>  |
| <b>RADIO RECEPTION</b>                                     |   |
| <b>Radio reception is poor.</b>                            | <ul style="list-style-type: none"> <li>– If the signal is too weak, adjust the antenna or connect an external antenna for better reception.</li> <li>– Increase the distance between the Micro HiFi System and your TV or VCR.</li> </ul>   |
| <b>GENERAL</b>   |   |
| <b>The system does not react when buttons are pressed.</b> | <ul style="list-style-type: none"> <li>– Remove and reconnect the AC power plug and switch on the system again.</li> </ul>  |
| <b>Sound cannot be heard or is of poor quality.</b>        | <ul style="list-style-type: none"> <li>– Adjust the volume.</li> <li>– Disconnect the headphones.</li> <li>– Check that the speakers are connected correctly.</li> <li>– Check if the stripped speaker wire is clamped.</li> </ul>  |
| <b>The left and right sound outputs are reversed.</b>      | <ul style="list-style-type: none"> <li>– Check the speaker connections and location.</li> </ul>   |
| <b>The remote control does not function properly.</b>      | <ul style="list-style-type: none"> <li>– Select the source (CD or TUNER, for example) before pressing the function button (▶  , ◀, ▶).</li> <li>– Reduce the distance between the remote control and the system.</li> <li>– Insert the batteries with their polarities (+/- signs) aligned as indicated.</li> <li>– Replace the batteries.</li> <li>– Point the remote control directly toward IR sensor on the front of the system.</li> </ul> |
| <b>The timer is not working.</b>                           | <ul style="list-style-type: none"> <li>– Set the clock correctly.</li> <li>– Press TIMER to switch on the timer.</li> </ul>   |
| <b>The Clock/Timer setting is erased.</b>                  | <ul style="list-style-type: none"> <li>– Power has been interrupted or the power cord has been disconnected. Reset the clock/timer.</li> </ul>  |

**RENEWED  
90 DAY  
LIMITED WARRANTY**