

Micro Hi-Fi System

MC235

user manual
manuel d'utilisation
manual del usuario



Read this manual first!

Congratulations on purchasing this Philips product. We've included everything you need to get started. If you have any problems, Philips Representatives can help you get the most from your new product by explaining:

- Hookups,
- First Time Setup, and
- Feature Operation.

Do not attempt to return this product to the store.

For fast help, call us first!

1-800-531-0039

Thank you for making Philips a part of your home!



PHILIPS

Canada

English:

This digital apparatus does not exceed the Class B limits for radio noise emissions from digital apparatus as set out in the Radio Interference Regulations of the Canadian Department of Communications.

Français:

Cet appareil numérique n'émet pas de bruits radioélectriques dépassant les limites applicables aux appareils numériques de Class B prescrites dans le Règlement sur le Brouillage Radioélectrique édicté par le Ministère des Communications du Canada.

This warning label is located on the rearside and inside this laser product.

CAUTION: INVISIBLE LASER RADIATION WHEN OPEN. DO NOT STARE INTO BEAM.

DANGER: INVISIBLE LASER RADIATION WHEN OPEN. AVOID DIRECT EXPOSURE TO BEAM.

VARO! AVATTAESSA JA SUOJALLUKITUS OHITETTAESSA OLET ALTTIINANÄKYMÄTTÖMÄALLE LASERSATEILYLLE. ÄLÄ KATSO SATEESEEN.

WARNING! OSYNLIG LASERSTRÅLNING NÄR DENNA DEL ÄR ÖPPNAD. OCH SPARREN ÄR URKOPPLAD. BETRÄKTA EJ STRÅLEN.

or

DANGER - Invisible laser radiation when open. AVOID DIRECT EXPOSURE TO BEAM.

CAUTION

Use of controls or adjustments or performance of procedures other than herein may result in hazardous radiation exposure or other unsafe operation.

ATTENTION

L'utilisation des commandes ou réglages ou le non-respect des procédures ci-incluses peuvent se traduire par une exposition dangereuse à l'irradiation.

ATENCIÓN

El uso de mando o ajustes o la ejecución de métodos que no sean los aquí descritos puede ocasionar peligro de exposición a radiación.

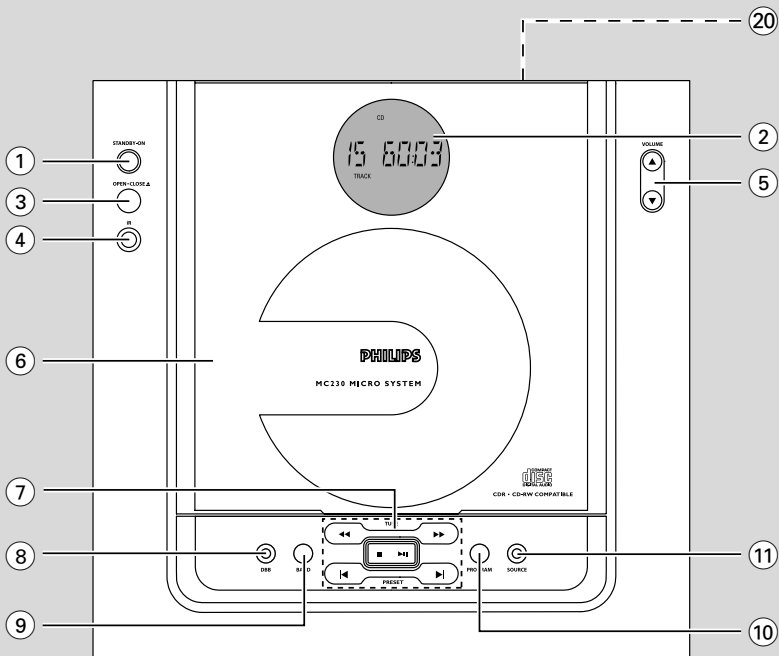
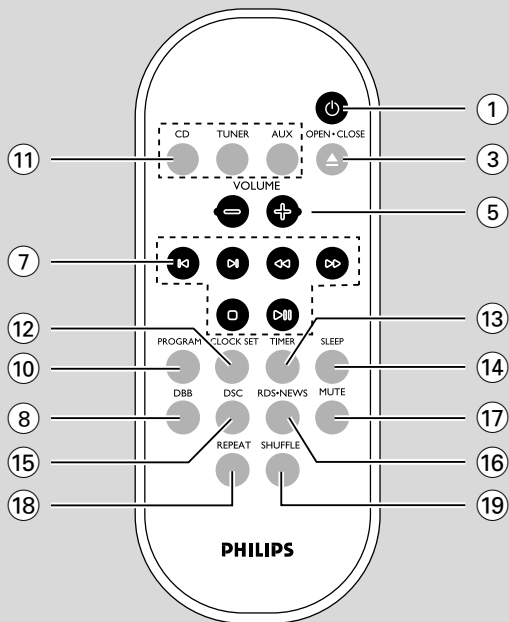

Return your Warranty Registration card today to ensure you receive all the benefits you're entitled to.

- Once your Philips purchase is registered, you're eligible to receive all the privileges of owning a Philips product.
- So complete and return the Warranty Registration Card enclosed with your purchase at once, and take advantage of these important benefits.

Warranty Verification

Registering your product within 10 days confirms your right to maximum protection under the terms and conditions of your Philips warranty.

Owner Confirmation

Your completed Warranty Registration Card serves as verification of ownership in the event of product theft or loss.

Model Registration

Returning your Warranty Registration Card right away guarantees you'll receive all the information and special offers which you qualify for as the owner of your model.

Know these safety symbols



 This “bolt of lightning” indicates uninsulated material within your unit may cause an electrical shock. For the safety of everyone in your household, please do not remove product covering.

 The “exclamation point” calls attention to features for which you should read the enclosed literature closely to prevent operating and maintenance problems.

For Customer Use

Enter below the Serial No. which is located on the rear of the cabinet. Retain this information for future reference.

Model No. _____

Serial No. _____

WARNING: TO PREVENT FIRE OR SHOCK HAZARD, DO NOT EXPOSE THIS EQUIPMENT TO RAIN OR MOISTURE.

CAUTION: To prevent electric shock, match wide blade of plug to wide slot, and fully insert.



PHILIPS



***Congratulations on your purchase,
and welcome to the “family!”***

Dear Philips product owner:

Thank you for your confidence in Philips. You've selected one of the best-built, best-backed products available today. And we'll do everything in our power to keep you happy with your purchase for many years to come.

As a member of the Philips “family,” you're entitled to protection by one of the most comprehensive warranties and outstanding service networks in the industry.

What's more, your purchase guarantees you'll receive all the information and special offers for which you qualify, plus easy access to accessories from our convenient home shopping network.

And most importantly you can count on our uncompromising commitment to your total satisfaction.

All of this is our way of saying welcome – and thanks for investing in a Philips product.

P.S. Remember, to get the most from your Philips product, you must return your Warranty Registration Card within 10 days. So please mail it to us right now!

IMPORTANT SAFETY INSTRUCTIONS

1. **Read these instructions.**
2. **Keep these instructions.**
3. **Heed all warnings.**
4. **Follow all instructions.**
5. **Do not use this apparatus near water.**
6. **Clean only with dry cloth.**
7. **Do not block any ventilation openings. Install in accordance with the manufacturer's instructions.**
8. **Do not install near any heat sources** such as radiators, heat registers, stoves, or other apparatus (including amplifiers) that produce heat.
9. **Do not defeat the safety purpose** of the polarized or grounding-type plug. A polarized plug has two blades with one wider than the other. A grounding type plug has two blades and a third grounding prong. The wide blade or the third prong are provided for your safety. If the provided plug does not fit into your outlet, consult an electrician for replacement of the obsolete outlet.

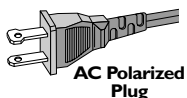

10. **Protect the power cord** from being walked on or pinched, particularly at plugs, convenience receptacles, and the point where they exit from the apparatus.
11. **Only use attachments/ accessories** specified by the manufacturer:

12.  **Use only with the cart**, stand, tripod, bracket, or table specified by the manufacturer or sold with the apparatus. When a cart is used, use caution when moving the cart/ apparatus combination to avoid injury from tip-over.

13. **Unplug this apparatus** during lightning storms or when unused for long periods of time.
14. **Refer all servicing** to qualified service personnel. Servicing is required when the apparatus has been damaged in any way, such as power-supply cord or plug is damaged, liquid has been spilled or objects have fallen into the apparatus, the apparatus has been exposed to rain or moisture, does not operate normally, or has been dropped.

15. **Battery usage CAUTION** – To prevent battery leakage which may result in bodily injury, property damage, or damage to the unit:
 - Install **all** batteries correctly, **+** and **-** as marked on the unit.
 - Do not mix batteries (**old** and **new** or **carbon** and **alkaline**, etc.).
 - Remove batteries when the unit is not used for a long time.

16. **Apparatus shall not be exposed to dripping or splashing.**
17. **Do not place any sources of danger on the apparatus.** (e.g. liquid filled objects, lighted candles).
18. This product may contain lead and mercury. Disposal of these materials may be regulated due to environmental considerations.

For disposal or recycling information, please contact your local authorities or the Electronic Industries Alliance: www.eiae.org.

Class II equipment symbol 
This symbol indicates that the unit has a double insulation system

English 8

Français 21

Español 38

English

Français

Español

General Information

Environmental information	9
Supplied accessories	9
Safety information	9

Preparations

Rear connections	10–11
Optional connection	11
Before using the remote control	11
Replacing battery (lithium CR2025) into the remote control	11

Controls

Controls on the system and remote control	12
---	----

Basic Functions

Switching the system on	13
Power-saving automatic standby	13
Adjusting volume and sound	13

CD Operation

Playing a disc	14
Selecting a different track	14
Finding a passage within a track	14
Different play modes: Shuffle and Repeat	15
Programming track numbers	15
Reviewing the programme	15
Erasing the programme	15

Radio Reception

Tuning to radio stations	16
Programming radio stations	16
Tuning to preset radio stations	16

Clock/Timer

Setting the clock	17
Viewing the clock	17
Setting the timer	17
Activating and deactivating TIMER	17
Activating and deactivating SLEEP	17

Specifications

Maintenance

Troubleshooting

This system complies with the FCC rules, Part 15 and with 21 CFR 1040. 10.

Operation is subject to the following two conditions:

- ***This device may not cause harmful interference, and***
- ***this device must accept any interference received, including interference that may cause undesired operation.***

Environmental Information

All unnecessary packaging has been omitted. We have tried to make the packaging easy to separate into three materials: cardboard (box), polystyrene foam (buffer) and polyethylene (bags, protective foam sheet).

Your system consists of materials which can be recycled and reused if disassembled by a specialized company. Please observe the local regulations regarding the disposal of packaging materials, exhausted batteries and old equipment.

Supplied accessories

- 2 speaker boxes
- remote control (with battery)
- AM loop antenna
- FM wire antenna
- stand
- screw and plug assembly

Safety Information

- Before operating the system, check that the operating voltage indicated on the typeplate (or the voltage indication beside the voltage selector) of your system is identical with the voltage of your local power supply. If not, please consult your dealer.
- Place the system on a flat, hard and stable surface.
- Place the system in a location with adequate ventilation to prevent internal heat build-up in your system. Allow at least 10 cm (4 inches) clearance from the rear and the top of the unit and 5 cm (2 inches) from each side.
- The ventilation should not be impeded by covering the ventilation openings with items, such as newspapers, table-cloths, curtains, etc.
- Do not expose the system, batteries or discs to excessive moisture, rain, sand or heat sources caused by heating equipment or direct sunlight.
- No naked flame sources, such as lighted candles, should be placed on the apparatus.
- No objects filled with liquids, such as vases, shall be placed on the apparatus.
- If the system is brought directly from a cold to a warm location, or is placed in a very damp room, moisture may condense on the lens of the disc unit inside the system. Should this occur, the CD player would not operate normally. Leave the power on for about one hour with no disc in the system until normal playback is possible.
- The mechanical parts of the set contain self-lubricating bearings and must not be oiled or lubricated.
- **When the system is switched to Standby mode, it is still consuming some power. To disconnect the system from the power supply completely, remove the AC power plug from the wall socket.**

Preparations

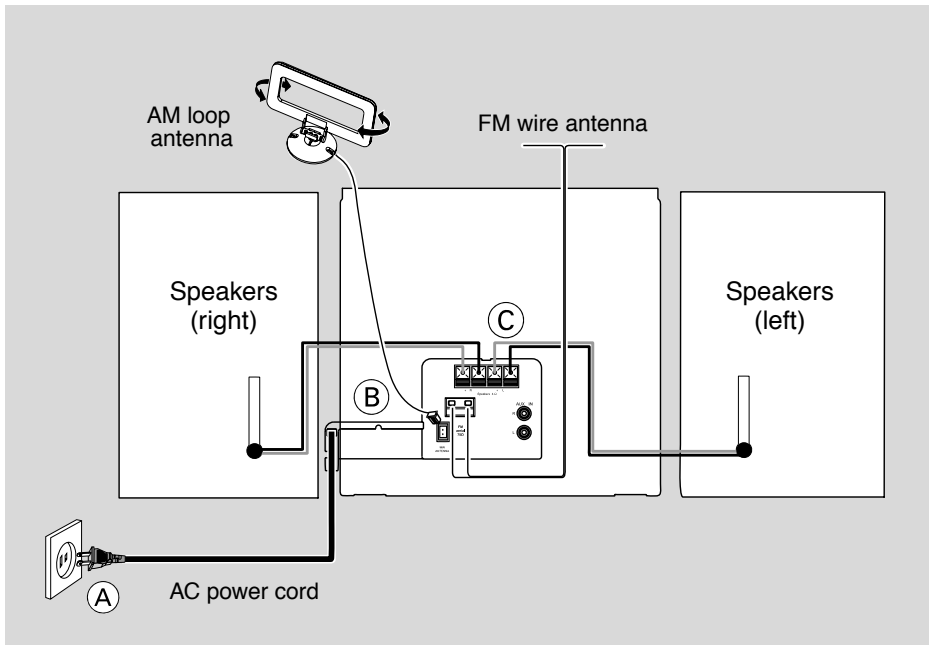

Rear connections

The type plate is located at the rear of the system.

A Power

Before connecting the AC power cord to the wall outlet, ensure that all other connections have been made.

WARNING!

- For optimal performance, use only the original power cable.
- Never make or change any connections with the power switched on.

To avoid overheating of the system, a safety circuit has been built in. Therefore, your system may switch to Standby mode automatically under extreme conditions. If this happens, let the system cool down before reusing it (not available for all versions).

B Antennas Connection

Connect the supplied AM loop antenna and FM antenna to the respective terminals. Adjust the position of the antenna for optimal reception.

AM Antenna

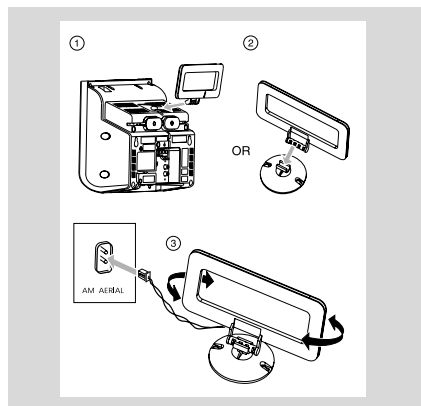

- Position the antenna as far as possible from a TV, VCR or other radiation source.

FM Antenna

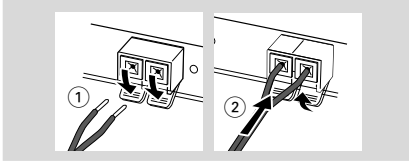

- For better FM stereo reception, connect an outdoor FM antenna to the FM AERIAL (FM ANTENNA) terminal.

C Speakers Connection

Front Speakers

Connect the speaker wires to the SPEAKERS terminals, right speaker to "RIGHT" and left speaker to "LEFT", coloured (marked) wire to "+" and black (unmarked) wire to "-".

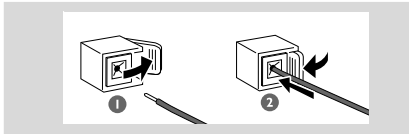

- Fully insert the stripped portion of the speaker wire into the terminal as shown.

Notes:

- For optimal sound performance, use the supplied speakers.
- Do not connect more than one speaker to any one pair of +/– speaker terminals.
- Do not connect speakers with an impedance lower than the speakers supplied. Please refer to the SPECIFICATIONS section of this manual.

Optional connection

The optional equipment and connecting cords are not supplied. Refer to the operating instructions of the connected equipment for details.

Connecting other equipment to your system

Connect the audio left and right OUT terminals of a TV,VCR, Laser Disc player, DVD player or CD Recorder to the **AUX-IN** terminals.

Note:

- If you are connecting equipment with a mono output (a single audio out terminal), connect it to the AUX IN left terminal. Alternatively, you can use a "single to double" cinch cable (the output sound still remain mono).

Before using the remote control

- 1 Pull out the plastic protective sheet.
- 2 Select the source you wish to control by pressing one of the source select keys on the remote control (for example CD,TUNER).
- 3 Then select the desired function (for example **▶▶** , **◀◀** , **▶|**).

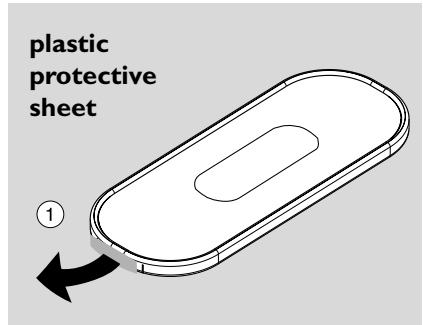

Replacing battery (lithium CR2025) into the remote control

- 1 Pull out the knob (A) slightly to the left.
- 2 Pull out the battery compartment (B).
- 3 Replace a new battery and fully insert the battery compartment back to the original position.

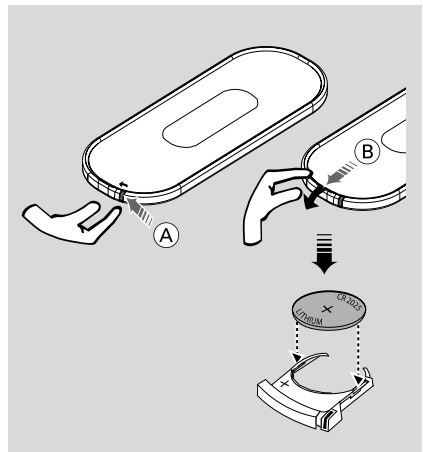

CAUTION!

Batteries contain chemical substances, so they should be disposed off properly.

Controls on the system and remote control

① STANDBY-ON

- switches the system on or to standby.

② Display

- shows the status of the system.

③ OPEN • CLOSE ▲

- opens/ closes the CD door.

④ IR

- remote sensor

⑤ VOLUME (▲ / ▼) (+ / -)

- adjusts the volume level.

⑥ CD Door

⑦ Mode Selection

SEARCH/TUNE (◀◀ / ▶▶)

for TUNERtunes to a station

for CDfast searches back and forward within a track/ CD.

STOP ■ stops CD playback or erases a CD programme.

PLAY ▶▶ starts or interrupts playback.

PRESET (◀ / ▶)

for TUNERselects a preset radio station.

for CDskips to the beginning of a current track/ previous/ subsequent track

⑧ DBB (Dynamic Bass Boost)

- enhances the bass.

⑨ BAND

- selects a waveband.

⑩ PROGRAM

for CD programmes tracks and reviews the programme.

for TUNER programmes tuner stations.

⑪ SOURCE

- selects the respective sound source for CD/ TUNER/ AUX.

⑫ CLOCK SET

- sets the clock function.
- views the clock.

⑬ TIMER

- activates/deactivates or sets the timer function.

⑭ SLEEP

- activates/deactivates or selects the sleeper time.

⑮ DSC (Digital Sound Control)

- selects sound characteristics: ROCK/ JAZZ/ POP/ CLASSIC.

⑯ RDS.NEWS

- activates RDS news and Traffic Announcement (not for all versions).

⑰ MUTE

- interrupts and resumes sound reproduction.

⑱ REPEAT

- repeats a track/ CD programme/ entire CD.

⑲ SHUFFLE

- plays CD tracks in random order.

⑳

- connects headphones

Notes for remote control:

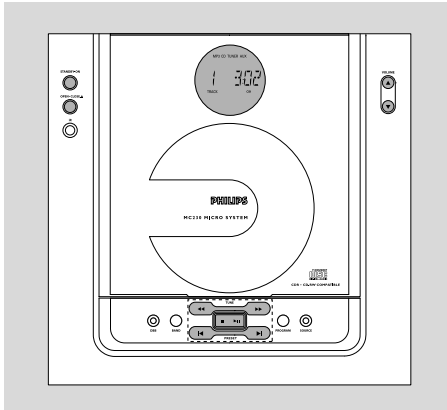

- First select the source you wish to control by pressing one of the source select keys on the remote control (for example CD, TUNER).
- Then select the desired function (for example ▶▶, ◀, ▶).



IMPORTANT!

Before you operate the system, complete the preparation procedures.

Switching the system on

- Press **STANDBY-ON** / .
 - The system will switch to the last selected source.
- Press **SOURCE** (or **CD**, **TUNER** or **AUX** on the remote control).
 - The system will switch to the selected source.
- Press **OPEN • CLOSE** .



To switch the system to standby mode

- Press **STANDBY-ON** / .
 - The backlight for clock display is dim in standby.
- The volume level (up to a maximum volume level of 20), interactive sound settings, last selected mode, source and tuner presets will be retained in the player's memory.

Power-saving automatic standby

As a power-saving feature, the system automatically switches to standby 15 minutes after a CD has reached the end and no control is operated.

Adjusting volume and sound

- 1 Press the **VOLUME**  /  (**+/-**) control to decrease or increase the volume.
 - Display shows the volume level  and a number from MIN1, 2, ...30, 31 MAX.
 - 2 Press **DSC** repeatedly to select the desired sound effect: **ROCK** / **JAZZ** / **POP** / **CLASSIC**.
 - 3 Press **DBB** to switch bass enhancement on or off.
 - Display shows: DBB.
 - 4 Press **MUTE** on the remote control to interrupt sound reproduction instantly.
 - Playback will continue without sound and the display shows **MUTE**.
- To activate sound reproduction you can:
 - press **MUTE** again;
 - adjust the volume controls;
 - change source.

CD Operation

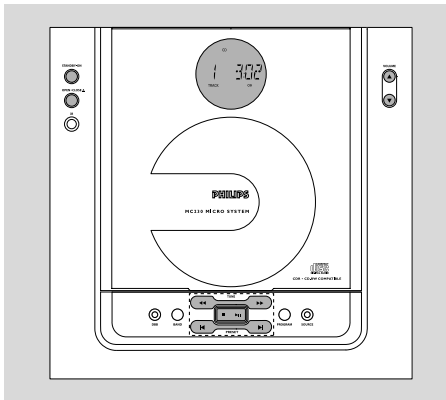

IMPORTANT!

The lens of the CD player should never be touched.

Playing a disc

This CD player plays Audio Discs including CD-Recordables and CD-Rewritables.

- CD-ROM, CD-I, CDV, VCD, MP3, DVD or computer CDs, however, are not possible.

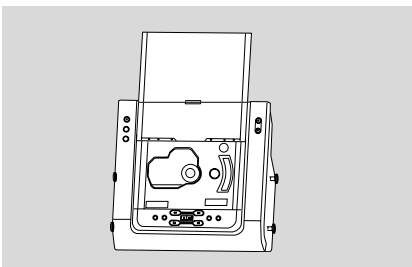

- 1 Press **SOURCE** to select CD.
- 2 Press **OPEN • CLOSE** ▲ on the front panel of the system to open the CD compartment.
→ **OPEN** is displayed when the compartment cover slides up.
- 3 Insert a disc with the printed side facing up. Press **OPEN • CLOSE** ▲ again to close the compartment.
→ **READING** is displayed as the CD player scans the contents of the disc.
→ The total playing time and the total number of tracks are displayed.

- 4 Press **▶||** to start playback.
→ Current track number and elapsed playing time of the track are displayed during disc playback.
- 5 To interrupt playback press **▶||**. Press **▶||** again to resume play.
- 6 To stop disc playback, press **STOP** ■.

Note: CD play will also stop when;

– *the CD door is opened.*

– *the disc has reached the end.*

– *you select another source: TUNER, AUX or standby.*

Selecting a different track

- Press **◀** or **▶** once or repeatedly until the desired track number appears in the display.
- If you have selected a track number shortly after loading a disc or in the PAUSE position, you will need to press **▶||** to start playback.

Finding a passage within a track

- 1 Press and hold **◀◀** or **▶▶**.
→ The disc is played at high speed and low volume.
- 2 When you recognise the passage you want, release **◀◀** or **▶▶**.
→ Normal playback continues.

Different play modes: SHUFFLE and REPEAT

You can select and change the various play modes before or during playback. The play modes can also be combined with PROGRAMME.

SHUFFLE tracks of the entire disc/ programme are played in random order

SHUFFLE and **REPEAT ALL** ... to repeat the entire disc/ programme continuously in random order

REPEAT ALL ... repeats the entire disc/ programme

REPEAT plays the current track continuously

- 1 To select your play mode, press the **SHUFFLE** or **REPEAT** button before or during playback until the display shows the desired function.
 - 2 Press **▶||** to start playback if in the STOP position.
→ If you have selected SHUFFLE, playback starts automatically.
 - 3 To return to normal playback, press the respective **SHUFFLE** or **REPEAT** button until the various SHUFFLE/ REPEAT modes are no longer displayed.
- You can also press **STOP ■** to cancel your play mode.

Programming track numbers

Programme in the STOP position to select and store your disc tracks in the desired sequence. If you like, store any track more than once. Up to 40 tracks can be stored in the memory.

- 1 Press **PROGRAM** to enter the programming mode.
→ A track number is shown and **PROGRAM** flashes.
- 2 Use the **◀** or **▶** to select your desired track number.
- 3 Press **PROGRAM** to confirm the track number to be stored.

→ The number of tracks programmed and the total playing time of the programme are shown briefly, then the selected track and *PRG*.

- 4 Repeat steps 2-3 to select and store all desired tracks.
→ *FULL* is displayed if you attempt to programme more than 40 tracks.
- 5 To start playback of your disc program, press **STOP ■** followed by **▶||** or press **▶||** directly.

Reviewing the programme

In **STOP** mode, press and hold down **PROGRAM** for a while until the display shows all your stored track numbers in sequence.

Erasing the programme

You can erase the programme by:

- pressing **STOP ■** once in the STOP mode;
- pressing **STOP ■** twice during playback;
- opening the CD compartment;
→ **PROGRAM** disappears.
→ *CLERR* scrolls and then disappears from the display.

Radio Reception

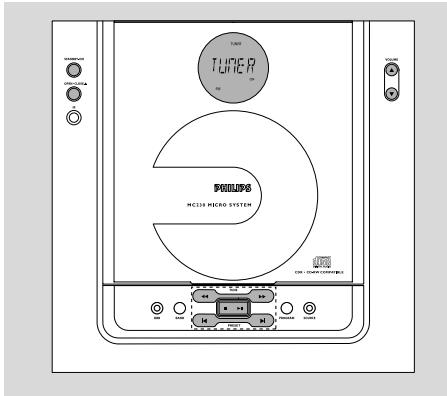

Tuning to radio stations

- 1 Press **SOURCE** to select **TUNER**.
→ **TUNER** is displayed briefly.
 - 2 Press **BAND** (or **TUNER** on the remote control) once or more to select your waveband. (FM/AM)
 - 3 Press and hold **TUNE** ◀◀ or ▶▶.
→ The radio automatically tunes to a station with sufficient reception. Display indication during automatic tuning: **SEARCH**.
 - 4 Repeat step 3 if necessary until you find the desired station.
- To tune to a weak station, press **TUNE** ◀◀ or ▶▶ briefly and repeatedly until you have found optimal reception.

Programming radio stations

You can store up to a total of 40 radio stations in the memory.

Automatic programming

Automatic programming will start with a chosen preset number: From this preset number upwards, former programmed radio stations will be overridden. The system will only program stations which are not in the memory already.

- 1 Press **PRESET** ◀ or ▶ to select the preset number where programming should start.

Note:

– If no preset number is selected, default is preset (1) and all your presets will be overridden.

- 2 Press **PROGRAM** for more than 2 seconds to activate programming.
→ **AUTO** is displayed and available stations are programmed in order of waveband reception strength: FM followed by AM. The last preset automatically stored will then be played.

Manual programming

- 1 Tune to your desired station (see Tuning to radio stations).
 - 2 Press **PROGRAM** to activate programming.
→ **PROGRAM** flashes in the display.
 - 3 Press **PRESET** ◀ or ▶ to allocate a number from 1 to 40 to this station.
 - 4 Press **PROGRAM** again to confirm the setting.
→ **PROGRAM** disappears, the preset number and the frequency of the preset station are shown.
 - 5 Repeat the above four steps to store other stations.
- You can override a preset station by storing another frequency in its place.

Tuning to preset radio stations

- Press **PRESET** ◀ or ▶ until the desired preset station is displayed.

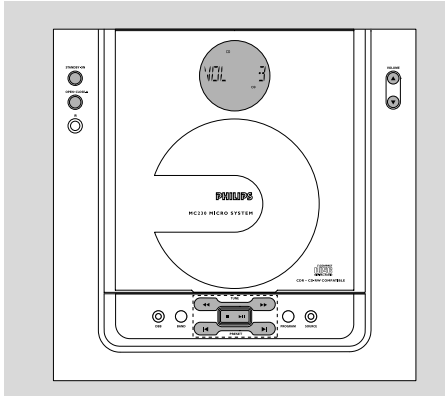

Setting the clock

- 1 In standby mode or system on, press and hold **CLOCK SET** on the remote control for more than 3 seconds.
→ **SET CLOCK** scrolls on the display.
→ The clock digits for the hours flash.
- 2 Press **VOLUME +/-** to set the hours.
- 3 Press **CLOCK SET** again.
→ The clock digits for the minutes flash.
- 4 Press **VOLUME +/-** to set the minutes.
- 5 Press **CLOCK SET** to confirm the time.

Note:

– The backlight for clock display is dim in standby.

Viewing the clock

Press **SET CLOCK**.

→ The clock time is displayed.

Setting the timer

- The system can be used as an alarm clock, whereby the CD,TUNER is switched on at a set time. The clock time needs to be set first before the timer can be used.
 - During setting, if no button is pressed within 90 seconds, the system will exit timer setting mode automatically.
- 1 In standby mode or system on, press and hold **TIMER** on the remote control for more than 3 seconds.
→ **SET TIMER** and **SELECT SOURCE** scrolls on the display.

- 2 Press **SOURCE** or **VOLUME +/-** to select sound source.
→ Display sequence shows **CD, TUNER**.
→  flashes.
- 3 Press **TIMER** to confirm your desired mode.
- 4 Press **VOLUME +/-** to set the hours.
- 5 Press **TIMER** again.
→ The clock digits for the minutes flash.
- 6 Press **VOLUME +/-** to set the minutes.
- 7 Press **TIMER** to confirm the time.
→ The timer is now set and activated.

Activating and deactivating TIMER

- Press **TIMER** on the remote to turn off the timer or turn on to the last setting again.
→ If activated, the timer information will display for a few seconds, then the system resumes to the last active source or stays in standby mode.
→ If deactivated, "OFF" appears.

Note:

– The system will exit timer setting mode if no button is pressed within 90 seconds.

Activating and deactivating SLEEP

The sleep timer enables the system to switch off by itself after a set period of time. The clock time needs to be set first before the sleep timer can be used.

- Press **SLEEP** on the remote control once or more.
→ Display shows **SLEEP** and one of the sleep time options in sequence: **90, 75, 60, ..., 45, 30, 15, OFF, 90**. If you have selected a time. Once **SLEEP** is activated, **SLEEP** scrolls across the display at repeated intervals.
- To deactivate, press **SLEEP** on the remote control once or more until **OFF** is shown, or press **STANDBY-ON** on the system or remote control.
→ **OFF** is displayed.

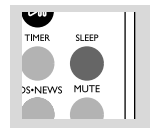

Specifications

AMPLIFIER

Output power 20W total power
..... 2 x 5 W RMS
..... 2 x 4 W FTC⁽¹⁾
Signal-to-noise ratio ≥ 65 dBA (IEC)
Frequency response 40 – 20000 Hz, ± 3 dB
Input sensitivity AUX 0.5V (max. 2V)
Impedance loudspeakers 4 Ω
Impedance headphones 32 Ω -1000 Ω
(1) (4 Ω , 60Hz - 12.5Hz, 10%THD)

CD PLAYER

Frequency range 20 – 20000 Hz
Signal-to-noise ratio 75 dBA

TUNER

FM wave range 87.5 – 108 MHz
AM wave range 530 – 1700 kHz
Sensitivity at 300 Ω
– mono, 26 dB signal-to-noise ratio 2.8 μ V
– stereo, 46 dB signal-to-noise ratio 61.4 μ V
Selectivity ≥ 28 dB
Total harmonic distortion $\leq 5\%$
Frequency response 63 – 12500 Hz (± 3 dB)
Signal-to-noise-ratio ≥ 50 dBA

SPEAKERS

Bass reflex system
Dimensions (w x h x d) 166 x 245 x 90 (mm)
..... 6.54 x 9.65 x 3.54 (inch)

GENERAL INFORMATION

AC Power Voltage 120V / 60 Hz
Dimensions (w x h x d) 250 x 245 x 96 (mm)
..... 9.84 x 9.65 x 3.78 (inch)
Weight (with/without speakers)
..... approx. 6.7 / 3.0 kg
..... approx. 14.8 / 6.62 pound
Standby power consumption < 3W

Subject to modification

Maintenance

Cleaning the Cabinet

- Use a soft cloth slightly moistened with a mild detergent solution. Do not use a solution containing alcohol, spirits, ammonia or abrasives.

Cleaning Discs

- When a disc becomes dirty, clean it with a cleaning cloth. Wipe the disc from the center out.
- Do not use solvents such as benzene, thinner, commercially available cleaners, or antistatic spray intended for analog records.

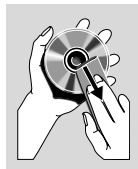

Cleaning the disc lens

- After prolonged use, dirt or dust may accumulate at the disc lens. To ensure good playback quality, clean the disc lens with Philips CD Lens Cleaner or any commercially available cleaner. Follow the instructions supplied with cleaner.

WARNING

Under no circumstances should you try to repair the system yourself, as this will invalidate the warranty. Do not open the system as there is a risk of electric shock.

If a fault occurs, first check the points listed below before taking the system for repair. If you are unable to remedy a problem by following these hints, consult your dealer or Philips for help.

Problem	Solution
CD OPERATION	
"NO DISC" is displayed.	<ul style="list-style-type: none"> – Insert a disc. – Check if the disc is inserted upside down. – Wait until the moisture condensation at the lens has cleared. – Replace or clean the disc, see "Maintenance". – Use a finalised CD-RW or CD-R.
RADIO RECEPTION	
Radio reception is poor.	<ul style="list-style-type: none"> – If the signal is too weak, adjust the antenna or connect an external antenna for better reception. – Increase the distance between the Micro HiFi System and your TV or VCR.
GENERAL	
The system does not react when buttons are pressed.	<ul style="list-style-type: none"> – Remove and reconnect the AC power plug and switch on the system again.
Sound cannot be heard or is of poor quality.	<ul style="list-style-type: none"> – Adjust the volume. – Disconnect the headphones. – Check that the speakers are connected correctly. – Check if the stripped speaker wire is clamped.
The left and right sound outputs are reversed.	<ul style="list-style-type: none"> – Check the speaker connections and location.
The remote control does not function properly.	<ul style="list-style-type: none"> – Select the source (CD or TUNER, for example) before pressing the function button (▶ , ◀, ▶). – Reduce the distance between the remote control and the system. – Insert the batteries with their polarities (+/- signs) aligned as indicated. – Replace the batteries. – Point the remote control directly toward IR sensor on the front of the system.
The timer is not working.	<ul style="list-style-type: none"> – Set the clock correctly. – Press TIMER to switch on the timer.
The Clock/Timer setting is erased.	<ul style="list-style-type: none"> – Power has been interrupted or the power cord has been disconnected. Reset the clock/timer.

LIMITED WARRANTY

AUDIO SYSTEM

One Year Free Labor

One Year Free Service on Parts

This product must be carried in for repair.

WHO IS COVERED?

You must have proof of purchase to receive warranty service. A sales receipt or other document showing that you purchased the product is considered proof of purchase.

WHAT IS COVERED?

Warranty coverage begins the day you buy your product. For one year thereafter, all parts will be repaired or replaced, and labor is free. After one year from the day of purchase, you pay for the replacement or repair of all parts, and for all labor charges. All parts, including repaired and replaced parts, are covered only for the original warranty period. When the warranty on the product expires, the warranty on all replaced and repaired parts also expires.

WHAT IS EXCLUDED?

Your warranty does not cover:

- labor charges for installation or setup of the product, adjustment of customer controls on the product, and installation or repair of antenna systems outside of the product.
- product repair and/or part replacement because of misuse, accident, unauthorized repair or other cause not within the control of Philips.
- reception problems caused by signal conditions or cable or antenna systems outside the unit.
- a product that requires modification or adaptation to enable it to operate in any country other than the country for which it was designed, manufactured, approved and/or authorized, or repair of products damaged by these modifications.
- incidental or consequential damages resulting from the product. (Some states do not allow the exclusion of incidental or consequential damages, so the above exclusion may not apply to you. This includes, but is not limited to, prerecorded material, whether copyrighted or not copyrighted.)
- a product that is used for commercial or institutional purposes.

WHERE IS SERVICE AVAILABLE?

Warranty service is available in all countries where the product is officially distributed by Philips. In countries where Philips does not distribute the product, the local Philips service organization will attempt to provide service (although there may be a delay if the appropriate spare parts and technical manual(s) are not readily available).

MAKE SURE YOU KEEP..

Please keep your sales receipt or other document showing proof of purchase. Attach it to this owner's manual and keep both nearby. Also keep the original box and packing material in case you need to return your product.

BEFORE REQUESTING SERVICE...

Please check your owner's manual for assistance. If you have additional questions, call us at 1-800-531-0039.

TO GET WARRANTY SERVICE IN U.S.A., PUERTO RICO, OR U.S. VIRGIN ISLANDS...

Take the product to a Philips factory service center (see enclosed list) or authorized service center for repair. When the product has been repaired, you must pick up the unit at the center. Centers may keep defective parts. (In U.S.A., Puerto Rico, and U.S. Virgin Islands, all implied warranties, including implied warranties of merchantability and fitness for a particular purpose, are limited in duration to the duration of this express warranty. But, because some states do not allow limitations on how long an implied warranty may last, this limitation may not apply to you.)

TO GET WARRANTY SERVICE IN CANADA...

Please contact Philips at:

1-800-661-6162 (French Speaking)

1-800-531-0039 (English or Spanish Speaking)

(In Canada, this warranty is given in lieu of all other warranties. No other warranties are expressed or implied, including any implied warranties of merchantability or fitness for a particular purpose. Philips is not liable under any circumstances for any direct, indirect, special, incidental or consequential damages, howsoever incurred, even if notified of the possibility of such damages.)

REMEMBER...

Please record below the model and serial numbers found on the product. Also, please fill out and mail your warranty registration card promptly. It will be easier for us to notify you if necessary.

MODEL # _____

SERIAL # _____

This warranty gives you specific legal rights. You may have other rights which vary from state/province to state/province.

Philips, P.O. Box 520890, Miami, FL 33152, USA, (402) 536-4171

EL4965E007 / 8-02