

Micro Hi-Fi System

MC150

User manual

Manuel d'utilisation

Manual del usuario

使用説明



PHILIPS

México



Es necesario que lea cuidadosamente su instructivo de manejo.

| | | |
|--|--|--|
| | PRECAUCIÓN - ADVERTENCIA No abrir, riesgo de choque eléctrico | |
| | ATENCIÓN Verifique que el voltaje de alimentación sea el requerido para su aparato | |
| Para evitar el riesgo de choque eléctrico, no quite la tapa. En caso de requerir servicio, dirijase al personal calificado. | | |

Descripción: **Microsistema de Audio**
Modelo : **MC150/ 21**
Alimentación: **110-127 / 220-240V; ~50-60 Hz**
Consumo: **25 W**
Importador: **Philips Mexicana, S.A. de C.V.**
Domicilio: **Av. La Palma No.6**
Col. San Fernando La Herradura
Huixquilucan
Localidad y Tel: **Edo. de México C.P. 52784**
Tel.52 69 90 00
Exportador: **Philips Electronics HK, Ltd.**
País de Origen: **China**
N° de Serie: _____

**LEA CUIDADOSAMENTE ESTE INSTRUCTIVO
ANTES DE USAR SU APARATO.**

AVISO IMPORTANTE

Philips Mexicana, S.A. de C.V. no se hace responsable por daños o desperfectos causados por:

- *Maltrato, descuido o mal uso, presencia de insectos o roedores (cucarachas, ratones etc.).*
- *Cuando el aparato no haya sido operado de acuerdo con el instructivo del uso, fuera de los valores nominales y tolerancias de las tensiones (voltaje), frecuencia (ciclaje) de alimentación eléctrica y las características que deben reunir las instalaciones auxiliares.*
- *Por fenómenos naturales tales como: temblores, inundaciones, incendios, descargas eléctricas, rayos etc. o delitos causados por terceros (choques asaltos, riñas, etc.).*

CAUTION

Use of controls or adjustments or performance of procedures other than herein may result in hazardous radiation exposure or other unsafe operation.

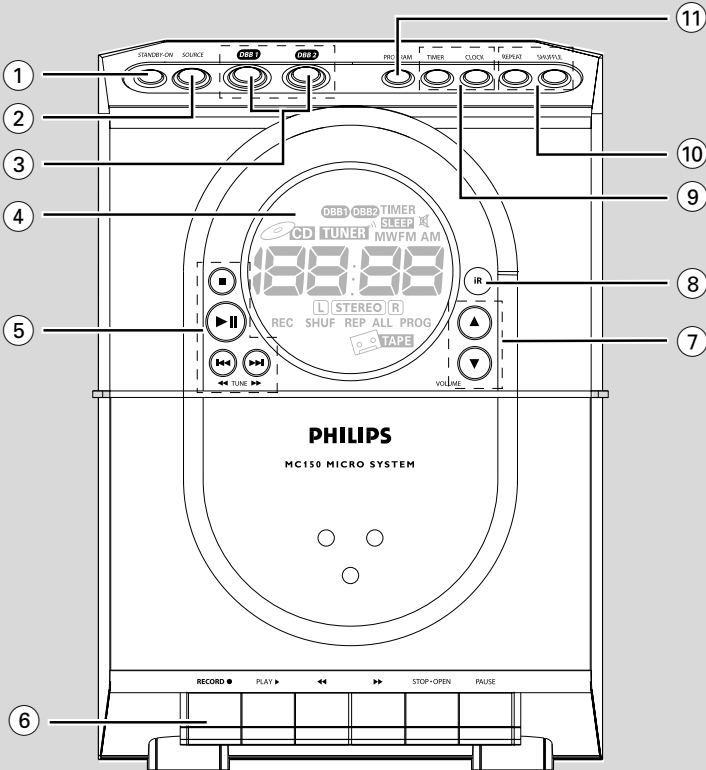
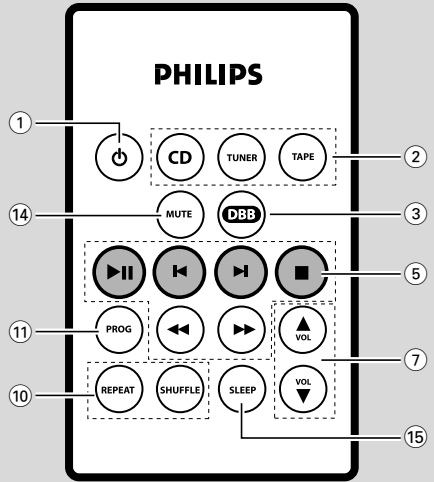
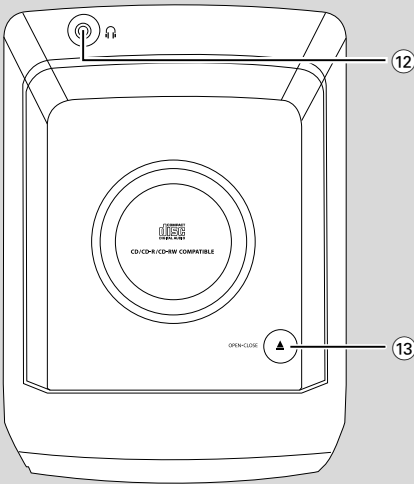

English 6

Français 22

Español 38

中文 54

English

Français

Español

中文

Contents

English

General Information

| | |
|---------------------------------|---|
| Environmental information | 7 |
| Supplied accessories | 7 |
| Safety information | 7 |

Preparation

| | |
|---|-----|
| Rear connections | 8-9 |
| Before using the remote control | 9 |
| Replacing battery (lithium CR2025) into the remote control | 9 |

Controls

| | |
|--|----|
| Controls on the system and remote control | 10 |
|--|----|

Basic Functions

| | |
|--------------------------------------|----|
| Switching the system on | 11 |
| Power-saving automatic standby | 11 |
| Adjusting volume and sound | 11 |

CD Operation

| | |
|--|----|
| Playing a disc | 12 |
| Selecting a different track | 12 |
| Finding a passage within a track | 12 |
| Different play modes: Shuffle and Repeat | 13 |
| Programming track numbers | 13 |
| Reviewing the programme | 13 |
| Erasing the programme | 13 |

Radio Reception

| | |
|---------------------------------------|----|
| Tuning to radio stations | 14 |
| Programming radio stations | 14 |
| Tuning to preset radio stations | 14 |
| Changing tuning grid | 15 |

Tape Operation/Recording

| | |
|--|-------|
| Tape playback | 16 |
| General information on recording | 16 |
| Synchro start CD recording | 16-17 |
| Recording from the radio | 17 |

Maintenance

Clock/Timer

| | |
|---|----|
| Setting the clock | 18 |
| Viewing the clock | 18 |
| Setting the timer | 18 |
| Activating and deactivating TIMER | 18 |
| Activating and deactivating SLEEP | 19 |

Specifications

Troubleshooting

IMPORTANT!

PLEASE NOTE THAT THE VOLTAGE SELECTOR LOCATED AT THE REAR OF THIS SYSTEM IS PRESET AT 220V FROM THE FACTORY. FOR COUNTRIES THAT OPERATE AT 110V-127V, PLEASE ADJUST TO 110V-127V BEFORE YOU SWITCH ON THE SYSTEM.

Environmental Information

All unnecessary packaging has been omitted. We have tried to make the packaging easy to separate into three materials: cardboard (box), polystyrene foam (buffer) and polyethylene (bags, protective foam sheet).

Your system consists of materials which can be recycled and reused if disassembled by a specialized company. Please observe the local regulations regarding the disposal of packaging materials, exhausted batteries and old equipment.

Supplied accessories

- 2 speaker boxes
- remote control with battery
- MW loop antenna

Safety Information

- Before operating the system, check that the operating voltage indicated on the typeplate (or the voltage indication beside the voltage selector) of your system is identical with the voltage of your local power supply. If not, please consult your dealer.
- Place the system on a flat, hard and stable surface.
- Place the system in a location with adequate ventilation to prevent internal heat build-up in your system. Allow at least 10 cm (4 inches) clearance from the rear and the top of the unit and 5 cm (2 inches) from each side.
- The ventilation should not be impeded by covering the ventilation openings with items, such as newspapers, table-cloths, curtains, etc.
- Apparatus shall not be exposed to dripping or splashing.
- Do not expose the system, batteries or discs to excessive moisture, rain, sand or heat sources caused by heating equipment or direct sunlight.
- No naked flame sources, such as lighted candles, should be placed on the apparatus.
- No objects filled with liquids, such as vases, shall be placed on the apparatus.
- If the system is brought directly from a cold to a warm location, or is placed in a very damp room, moisture may condense on the lens of the disc unit inside the system. Should this occur, the CD player would not operate normally. Leave the power on for about one hour with no disc in the system until normal playback is possible.
- The mechanical parts of the set contain self-lubricating bearings and must not be oiled or lubricated.
- **When the system is switched to Standby mode, it is still consuming some power. To disconnect the system from the power supply completely, remove the AC power plug from the wall socket.**

Preparations

English

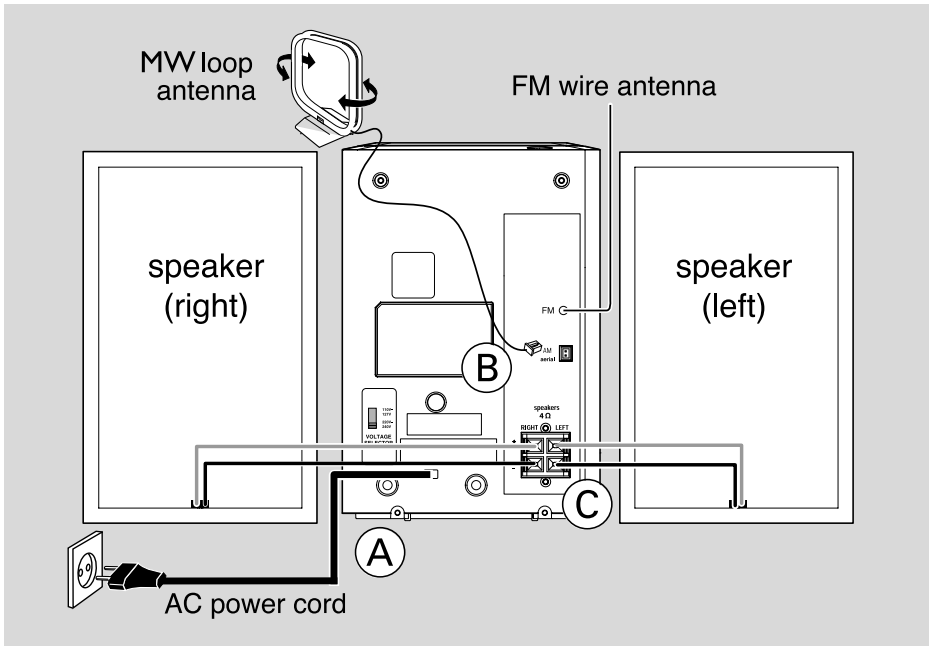

Rear connections

The type plate is located at the rear of the system.

A Power

Before connecting the AC power cord to the wall outlet, ensure that all other connections have been made.

- If your system is equipped with a Voltage Selector, set the VOLTAGE SELECTOR to the local power line voltage.

WARNING!

- **For optimal performance, use only the original power cable.**
- **Never make or change any connections with the power switched on.**

To avoid overheating of the system, a safety circuit has been built in. Therefore, your system may switch to Standby mode automatically under extreme conditions. If this happens, let the system cool down before reusing it (not available for all versions).

B Antennas Connection

Connect the supplied MW loop antenna and FM antenna to the respective terminals. Adjust the position of the antenna for optimal reception.

MW Antenna

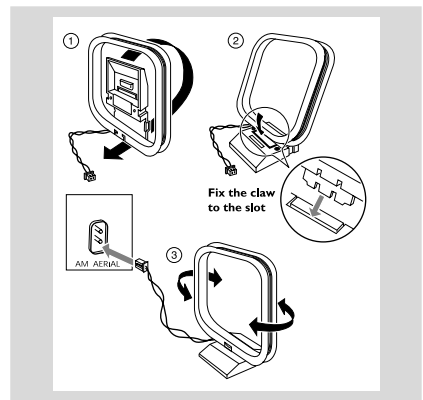

- Position the antenna as far as possible from a TV, VCR or other radiation source.

FM Antenna

- Extend coil antenna at the back of the unit fully for optimum reception.

Speakers Connection

Front Speakers

Connect the speaker wires to the SPEAKERS terminals, right speaker to "RIGHT" and left speaker to "LEFT", coloured (marked) wire to "+" and black (unmarked) wire to "-".

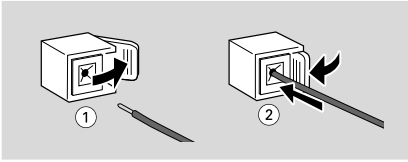

- Fully insert the stripped portion of the speaker wire into the terminal as shown.

Notes:

- For optimal sound performance, use the supplied speakers.
- Do not connect more than one speaker to any one pair of + / - speaker terminals.
- Do not connect speakers with an impedance lower than the speakers supplied. Please refer to the SPECIFICATIONS section of this manual.

Before using the remote control

- 1 Pull out the plastic protective sheet.
- 2 Select the source you wish to control by pressing one of the source select keys on the remote control (for example CD, TUNER).
- 3 Then select the desired function (for example ▶, ◀, ▶|).

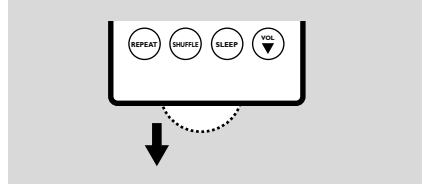

Replacing battery (lithium CR2025) into the remote control

- 1 Pull out the knob (A) slightly to the right.
- 2 Pull out the battery compartment (B).
- 3 Replace a new battery and fully insert the battery compartment back to the original position.

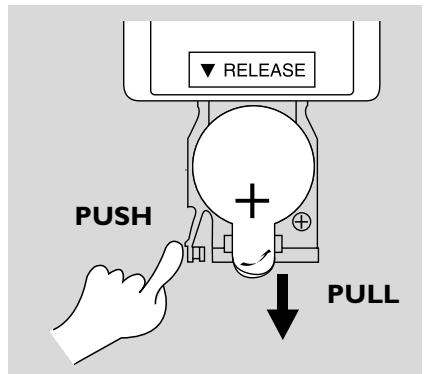

CAUTION!

Batteries contain chemical substances, so they should be disposed off properly.

Controls (illustrations on page 3)

Controls on the system and remote control

- ① **STANDBY-ON** / 
 - switches the system to standby/on. - ② **SOURCE (CD/TUNER/TAPE)**
 - switches on the system.
 - selects the respective sound source for CD/ FM/ MW/ TAPE. - ③ **DBB1 / DBB2 (DBB)**
 - (Dynamic Bass Boost) enhances the bass. - ④ **Display**
 - shows the status of the system. - ⑤ **Mode Selection**
 - STOP** ■
 - for CD stops CD playback or erase a CD program. - PLAY-PAUSE** ► II
 - for CD starts or pauses CD playback. - ◀◀ / ▶▶ / ◀◀ TUNE ▶▶** (◀ / ▶)
 - for CD skips to the beginning of a current track/previous/ next track.
 - fast searches back and forward within a track/CD. - for Tuner tunes to radio stations.
 - selects a preset radio station.
- ⑥ **Tape Deck Operation**
- RECORD** ● starts recording.
 - PLAY** ► starts playback.
 - ◀◀ / ▶▶** fast rewinds/forwards the tape.
 - STOP-OPEN** ... stops the tape; opens the tape compartment.
 - PAUSE** pauses recording or playback.
- ⑦ **VOLUME ▲ / ▼ (VOL ▲ / ▼)**
- adjusts volume level.
 - adjusts the hours and minutes for clock/ timer functions.
- ⑧ **iR SENSOR**
- infrared sensor for remote control.
- ⑨ **TIMER / CLOCK**
- activates/deactivates or sets the timer function.
 - sets the clock function.
 - views the clock time.
- ⑩ **REPEAT / SHUFFLE**
- repeats a track/CD program/ entire CD.
 - plays CD tracks in random order.

- ⑪ **PROGRAM (PROG)**

 - for CD programs tracks and reviews the program.
 - for Tuner programs tuner stations manually or automatically.

- ⑫ 

 - connect headphones.

- ⑬ **OPEN-CLOSE**

 - opens/closes the CD door:

- ⑭ **MUTE**

 - switches playback sound off and on.

- ⑮ **SLEEP**

 - activates/deactivates or selects the sleeper time.

Notes for remote control:

- **First select the source you wish to control by pressing one of the source select keys on the remote control (for example CD , TUNER).**
- **Then select the desired function (for example ►, ◀, ▶).**

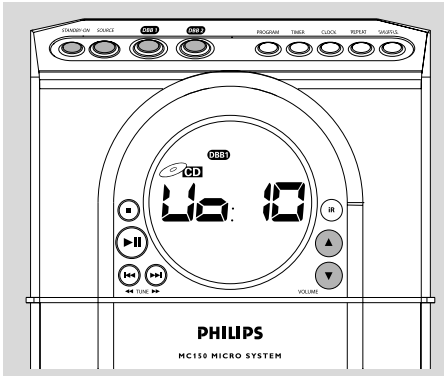

IMPORTANT:
Before you operate the system, complete the preparation procedures.

Switching the system on

- Press **STANDBY-ON** (⏻ on the remote control) or **SOURCE**.
 → The system will switch to the last selected source.
- Press **SOURCE** (**CD**, **TUNER** or **TAPE** on the remote control).
 → The system will switch to the selected source.

To switch the system to standby mode

- Press **STANDBY-ON** (⏻ on the remote control).
- If in tape mode or recording mode, press **STOP•OPEN** first.
 → The volume level (up to maximum volume level of 20), interactive sound settings, last selected source and tuner presets will be retained in the player's memory.

Power-saving automatic standby

The power-saving feature automatically switches to standby 15 minutes after a tape or CD playback has ended and no control is operated.

Adjusting volume and sound

- 1 Press **VOLUME ▲ / ▼** (**VOL ▲ / ▼** on the remote control) to increase or decrease volume.
 → Display shows the volume level **U** and a number from 0-32.
- 2 Press **DBB 1** or **DBB 2** (**DBB** on the remote control) to switch bass enhancement on or off.
 → Display shows: **DBB1** or **DBB2** if the DBB is activated.
- 3 Press **MUTE** on the remote control to stop sound playback instantly.
 → Playback will continue without sound and the display shows .



- To start sound playback you can:
 - press **MUTE** again;
 - adjust the volume controls;
 - change source.

CD Operation

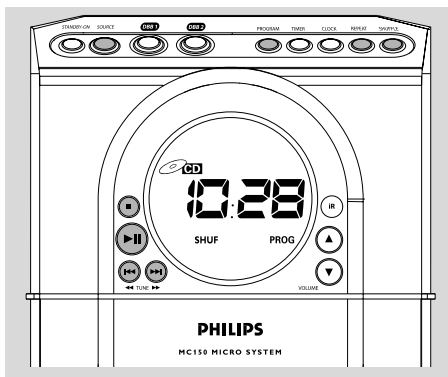

IMPORTANT:

The lens of the CD player should never be touched.

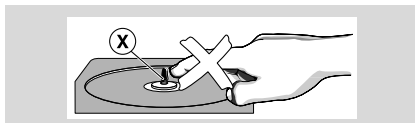

Playing a disc

This CD player plays Audio Discs including CD-Recordables and CD-Rewritables.

- CD-ROM, CD-I, CDV, VCD, DVD or computer CDs, however, are not possible.

1 Select **CD** source.

2 Press **OPEN•CLOSE** on the top of the system to open the CD compartment.

→ *OPEN* is displayed when you open the CD compartment.

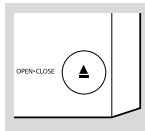

3 Insert a disc with the printed side facing up and press down on **OPEN•CLOSE** to close the CD door:

→ *READY* is displayed as the CD player scans the contents of a disc. The total number of tracks are also shown.

4 Press **▶||** to start playback.

→ Current track number followed by elapsed playing time of the track are displayed during disc playback.

5 To pause playback press **▶||**. Press **▶||** again to resume play.

→ The display freezes and the current track number flashes when playback is paused.

6 To stop disc playback, press **■**.

Note: CD play will also stop when;

– the CD door is opened.

– the disc has reached the end.

– you select another source: **TAPE, TUNER**.

– you select standby.

– you press the tape deck **PLAY ▶** key.

Selecting a different track

- Press **◀◀** or **▶▶** (**◀◀** or **▶▶** on remote control) once or repeatedly until the desired track number appears in the display.

- If you have selected a track number shortly after loading a disc, or in the **PAUSE** position, you will need to press **▶||** to start playback.

Finding a passage within a track

1 Press and hold down **◀◀** or **▶▶** (**◀◀** or **▶▶** on remote control).

→ The disc is played at high speed and low volume.

2 When you find the passage you want, release **◀◀** or **▶▶** (**◀◀** or **▶▶** on remote control).

→ Normal playback continues.

Note:

– During a disc programme or if **SHUFFLE/REPEAT** active, searching is only possible within the same track.

Different play modes: SHUFFLE and REPEAT

You can select and change the various play modes before or during playback. The play modes can also be combined with PROGRAMME.

SHUFFLEtracks of the entire disc/ programme are played in random order

SHUFFLE and **REPEAT ALL** ...to repeat the entire disc/ programme continuously in random order

REPEAT ALL ...repeats the entire disc/ programme

REPEATplays the current track continuously

- 1 To select your play mode, press the **SHUFFLE** or **REPEAT** button before or during playback until the display shows the desired function.
- 2 Press **▶II** to start playback if in the STOP position.
→ If you have selected SHUFFLE, playback starts automatically.
- 3 To return to normal playback, press the respective **SHUFFLE** or **REPEAT** button until the various SHUFFLE/ REPEAT modes are no longer displayed.
- You can also press **■** to cancel your play mode.

Programming track numbers

Programme in the STOP position to select and store your disc tracks in the desired sequence. If you like, store any track more than once. Up to 20 tracks can be stored in the memory.

- 1 Press **PROGRAM (PROG)** on the remote control) to enter the programming mode.
→ **P - 0 9** is shown and **PROG** flashes.
- 2 Use the **◀◀** or **▶▶** (**◀** or **▶** on remote control) to select your desired track number.
- 3 Press **PROGRAM (PROG)** on the remote control) to confirm the track number to be stored.
→ Next program number **P - 0** is displayed.
- 4 Repeat steps 2-3 to select and store all desired tracks.
→ **FULL L** is displayed if you attempt to programme more than 20 tracks.
- 5 To start playback of your disc programme, press **▶II**

Note:

– If you wish, you can add further tracks to your current program. Make sure you are in the STOP position, and that you have not exceeded 20 tracks.

Reviewing the programme

In STOP mode, press and hold down **PROGRAM (PROG)** on the remote control) for a while until the display shows all your stored track numbers in sequence.

Erasing the programme

You can erase the programme by:

- pressing **■** once in the STOP mode;
- pressing **■** twice during playback;
- opening the CD compartment;
→ **PROG** disappears from the display.

Radio Reception

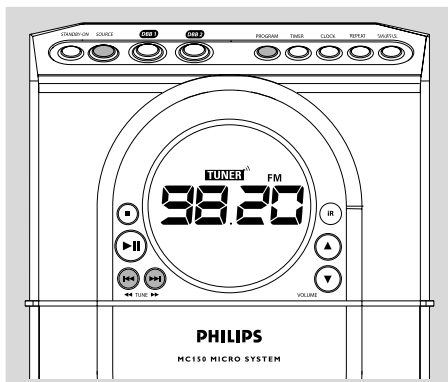

Tuning to radio stations

- 1 Select **TUNER** source.
→ **FM** is displayed briefly.
 - 2 Press **SOURCE (TUNER)** on the remote control) once or more to select your waveband.
 - 3 Press on **TUNE** **◀** or **▶** and release button.
→ The radio automatically tunes to a station with sufficient reception. Display indication during automatic tuning **Srch**.
 - 4 Repeat step 3 if necessary until you find the desired station.
- To tune to a weak station, press **TUNE** **◀** or **▶** briefly and repeatedly until you have found optimal reception.

Programming radio stations

You can store up to a total of 30 (20 FW and 10 MW) radio stations in the memory.

Automatic programming

Automatic programming will start with a chosen preset number 1. From this preset number upwards, former programmed radio stations will be overridden.

- 1 Press **SOURCE (TUNER)** on the remote control) once or more to select your waveband.
- 2 Press **◀** or **▶** (on the remote control) to select the preset number where programming should start.

Note:

– *If no preset number is selected, default is preset (1) and all your presets will be overridden.*

- 3 Press **PROGRAM (PROG)** on the remote control) for more than 2 seconds to activate programming.
→ **RLS** is displayed and available stations are programmed in order of waveband reception strength.

Manual programming

- 1 Tune to your desired station (see Tuning to radio stations).
 - 2 Press **PROGRAM (PROG)** on the remote control) to activate programming.
→ **PROG** flashes in the display.
 - 3 Press **◀** or **▶** (on the remote control) to select a number from 1 to 20 for FM (or 1 to 10 for MW) to this station.
 - 4 Press **PROGRAM (PROG)** on the remote control) again to confirm the setting.
→ **PROG** disappears and the frequency of the preset station is shown.
 - 5 Repeat the above four steps to store other stations.
- You can override a preset station by storing another frequency in its place.

Tuning to preset radio stations

- Press **◀** or **▶** (on the remote control) until the desired preset station is displayed.

Changing tuning grid *(not available for all versions)*

In North and South America, the frequency step between adjacent channels in the MW band is 10 kHz (9 kHz in some areas). The preset frequency step in the factory is 9 kHz.

Changing the tuning grid will erase all previously stored preset radio stations.

- 1** Select **TUNER** source or in the tuner mode.
- 2** Press **STOP** on the set for at least 5 seconds.
→ The display will show "9 9" or "9 : 0".

Notes:

- *GRID 9 and GRID 10 indicate that the tuning grid is in step of 9 kHz and 10 kHz respectively.*
- *The FM tuning grid also will be changed from 50 kHz to 100 kHz or vice versa.*

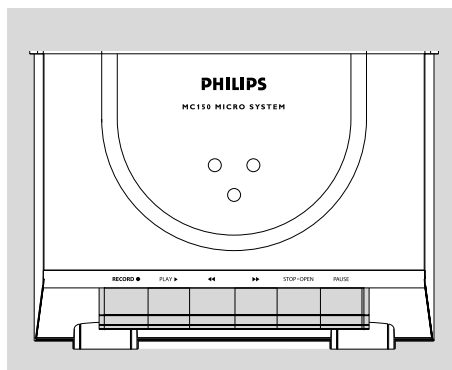

Tape playback

- 1 Select **TAPE** source.
→ Display: shows *tape* throughout tape operation.
 - 2 Press **STOP-OPEN** to open the tape door.
 - 3 Insert a recorded tape and close the tape door:
 - Load the tape with the open side downward and the full spool to the left.
 - 4 Press **PLAY** ► to start playback.
 - 5 To pause, press **PAUSE**. Press again to resume.
 - 6 Press ◀◀ or ▶▶ to fast wind tape in either direction.
 - 7 To stop the tape, press **STOP-OPEN**.
- The keys are automatically released at the end of a tape, except if **PAUSE** has been activated.

Note:

- The sound source cannot be changed while playing and recording a tape.

General information on recording

- Recording is permissible insofar as copyright or other rights of third parties are not infringed.
- For recording, use only **NORMAL** (IEC type I) tapes on which the tabs have not yet been broken. This deck is not suited for recording on **METAL** (IEC IV) type tapes.
- The best recording level is set automatically. Altering the **VOLUME** or **DBB** controls will not affect the recording in progress.
- The recording sound quality might differ depending on the quality of your recording source and the recording tape.
- At the very beginning and end of the tape, no recording will take place during the 7 seconds when the leader tape passes the recorder heads.
- To protect a tape from accidental erasure, have the tape in front of you and break out the left tab. Recording on this side is no longer possible. If, however, you wish to record over this side again, cover the tabs with a piece of adhesive tape.

Synchro start CD recording

- 1 Select **CD** source.
- 2 Insert a disc and if desired, programme track numbers.
- 3 Press **STOP-OPEN** to open the tape door.
- 4 Insert a suitable tape into the deck and close the tape door.
- 5 Press **RECORD** ● to start recording.
→ Playing of the CD programme starts automatically from the beginning of the CD after 7 seconds. It is not necessary to start the CD player separately.

To select and record a particular passage within a CD track:

- Press and hold down on ◀◀ or ▶▶. Release the control when you recognize the passage you want.
 - To interrupt CD playback press ▶||.
 - Recording starts from this exact point in the track when you press **RECORD** ●.
- 6** To pause, press **PAUSE**. Press again to resume.
- 7** To stop recording, press **STOP•OPEN**.

Recording from the radio

- 1** Tune to the desired radio station (see Tuning to radio stations).
- 2** Press **STOP•OPEN** to open the tape door.
- 3** Insert a suitable tape into the deck and close the tape door.
- 4** Press **RECORD** to start recording.
- 5** To pause, press **PAUSE**. Press again to resume.
- 6** To stop recording, press **STOP•OPEN**.

Maintenance

Cleaning the Cabinet

- Use a soft cloth slightly moistened with a mild detergent solution. Do not use a solution containing alcohol, spirits, ammonia or abrasives.

Cleaning Discs

- When a disc becomes dirty, clean it with a cleaning cloth. Wipe the disc from the centre out.
- Do not use solvents such as benzene, thinner, commercially available cleaners, or antistatic spray intended for analogue records.



Cleaning the disc lens

- After prolonged use, dirt or dust may accumulate at the disc lens. To ensure good playback quality, clean the disc lens with Philips CD Lens Cleaner or any commercially available cleaner. Follow the instructions supplied with cleaner.

Cleaning the Heads and the Tape Paths

- To ensure good recording and playback quality, clean the heads (A), the capstan(s) (B), and pressure roller(s) (C) after every 50 hours of tape operation.
- Use a cotton swab slightly moistened with cleaning fluid or alcohol.
- You can also clean the heads by playing a cleaning tape once.

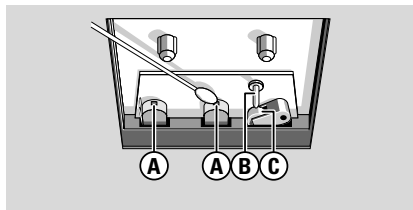

Demagnetising the heads

- Use a demagnetising tape available at your dealer.

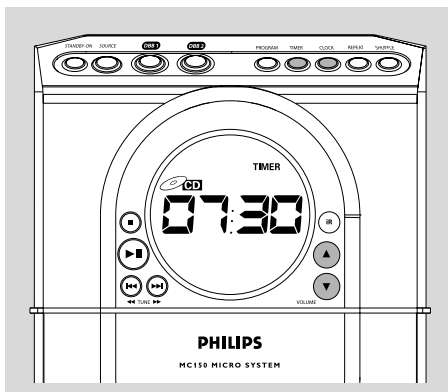

Setting the clock

- 1 Press and hold **CLOCK** button.
→ The clock digits for the hours flash.
- 2 Press **VOLUME ▲ / ▼** (**VOL ▲ / ▼** on the remote control) to set the hours.
- 3 Press **CLOCK** again.
→ The clock digits for the minutes flash.
- 4 Press **VOLUME ▲ / ▼** (**VOL ▲ / ▼** on the remote control) to set the minutes.
- 5 Press **CLOCK** to confirm the time.

Viewing the clock

To view the clock time in any source mode, press **CLOCK**, the clock time will be displayed for few seconds.

Note:

– If the clock has not been set, –:– will be displayed.

Setting the timer

- The system can be used as an alarm clock. CD or TUNER can be set to switch on at a preset time. The clock time needs to be set first before the timer can be used.
- If no button is pressed within 90 seconds during timer setup, the system will exit timer setting mode automatically.

- 1 In any mode, press **TIMER** for more than 2 seconds.
- 2 Press **SOURCE** (**VOL ▲ / ▼** on the remote control) to select sound source.
- 3 Press **TIMER** to confirm your desired source.
→ The selected source **CD** or **TUNER** is shown. The clock digits for the hours flash.
- 4 Press **VOLUME ▲ / ▼** (**VOL ▲ / ▼** on the remote control) to set the hours.
- 5 Press **TIMER** again.
→ The clock digits for the minutes flash.
- 6 Press **VOLUME ▲ / ▼** (**VOL ▲ / ▼** on the remote control) to set the minutes.
- 7 Press **TIMER** to confirm the time.
→ The timer is now set and actiated.

Note:

- Timer will not start if recording is in progress
- If source CD is selected and no disc is in the CD tray or the disc has an error, TUNER will be selected automatically.

Activating and deactivating TIMER

- In standby or during playback, press **TIMER** once.
→ Display shows **TIMER** if activated, and disappears if deactivated.

Activating and deactivating SLEEP

The sleep timer enables the system to switch off by itself after a set period of time. The clock time needs to be set first before the sleep timer can be used.

- Press **SLEEP** on the remote control repeatedly to select desired time before system shuts off.

→ Display shows **SLEEP** and series of time options for selection: *60, 45, 30, 15, OFF, 60*.

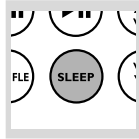

- To deactivate, press **SLEEP** on the remote control once or more until *OFF* is shown, or press **STANDBY ON** on the system or remote control.

Specifications

AMPLIFIER

Output power 200 W PMPO
 2 x 5 W RMS
 Signal-to-noise ratio ≥ 62 dBA (IEC)
 Frequency response 60 – 16000 Hz, ± 3 dB
 Impedance loudspeakers 4 Ω
 Impedance headphones 32 Ω – 1000 Ω

CD PLAYER

Frequency range 20 – 20000 Hz
 Signal-to-noise ratio 75 dBA

TUNER

FM wave range 87.5 – 108 MHz
 MW wave range (9 kHz) 531 – 1602 kHz
 MW wave range (10 kHz) 530 – 1700 kHz
 Tuning grid 9/10 kHz
 Sensitivity at 75 Ω
 – mono, 26 dB signal-to-noise ratio 2.8 μ V
 – stereo, 46 dB signal-to-noise ratio 61.4 μ V
 Selectivity ≥ 28 dB
 Total harmonic distortion $\leq 5\%$
 Frequency response 63 – 12500 Hz (± 3 dB)
 Signal-to-noise-ratio ≥ 50 dBA

TAPE DECK

Frequency response
 Normal tape (type I) ... 120 – 10000 Hz (8 dB)
 Signal-to-noise ratio
 Normal tape (type I) 48 dBA
 Wow and flutter $\leq 0.4\%$ DIN

SPEAKERS

Bass reflex system
 Dimensions (w x h x d) . 150 x 222 x 183 (mm)

GENERAL INFORMATION

AC Power
 For Version /21-21M .. 110 – 127 / 220 – 240V;
 50/60 Hz Switchable
 For Version /30 230 – 240V; 50 Hz
 Dimensions (w x h x d) 156 x 222 x 215.5 (mm)
 Weight (with/without speakers)
 approx. 4.9 / 2.3 kg
 Standby power consumption < 3 W

Subject to modification

Troubleshooting

WARNING

Under no circumstances should you try to repair the system yourself, as this will invalidate the warranty. Do not open the system as there is a risk of electric shock.

If a fault occurs, first check the points listed below before taking the system for repair. If you are unable to remedy a problem by following these hints, consult your dealer or service centre.

| Problem | Solution |
|---------|----------|
|---------|----------|

CD OPERATION

"no cd" is displayed.

- Insert a disc.
 - Check if the disc is inserted upside down.
 - Wait until the moisture condensation at the lens has cleared.
 - Replace or clean the disc, see "Maintenance".
 - Use a finalised CD-RW or CD-R.
-

RADIO RECEPTION

Radio reception is poor.

- If the signal is too weak, adjust the antenna or connect an external antenna for better reception.
 - Increase the distance between the Micro HiFi System and your TV or VCR.
-

TAPE OPERATION / RECORDING

Recording or playback cannot be made.

- Clean deck parts, see "Maintenance".
 - Use only normal (IEC I) tape for recording.
 - Apply a piece of adhesive tape over the missing tab space.
-

GENERAL

The system does not react when buttons are pressed.

- Remove and reconnect the AC power plug and switch on the system again.
-

Sound cannot be heard or is of poor quality.

- Adjust the volume.
 - Disconnect the headphones.
 - Check that the speakers are connected correctly.
 - Check if the stripped speaker wire is clamped.
-

The left and right sound outputs are reversed.

- Check the speaker connections and location.
-

The remote control does not function properly.

- Select the source (CD or TUNER, for example) before pressing the function button (▶, ◀, ▶).
- Reduce the distance between the remote control and the system.
- Insert the batteries with their polarities (+/- signs) aligned as indicated.
- Replace the batteries.
- Point the remote control directly toward IR sensor on the front of the system.

The timer is not working.

- Set the clock correctly.
- Press **TIMER** to switch on the timer.
- If a recording is in progress, stop the recording.

The Clock/Timer setting is erased.

- Power has been interrupted or the power cord has been disconnected. Reset the clock/timer.
-