

Micro Hi-Fi System

MC145

User manual

使用説明

Руководство пользователя



PHILIPS

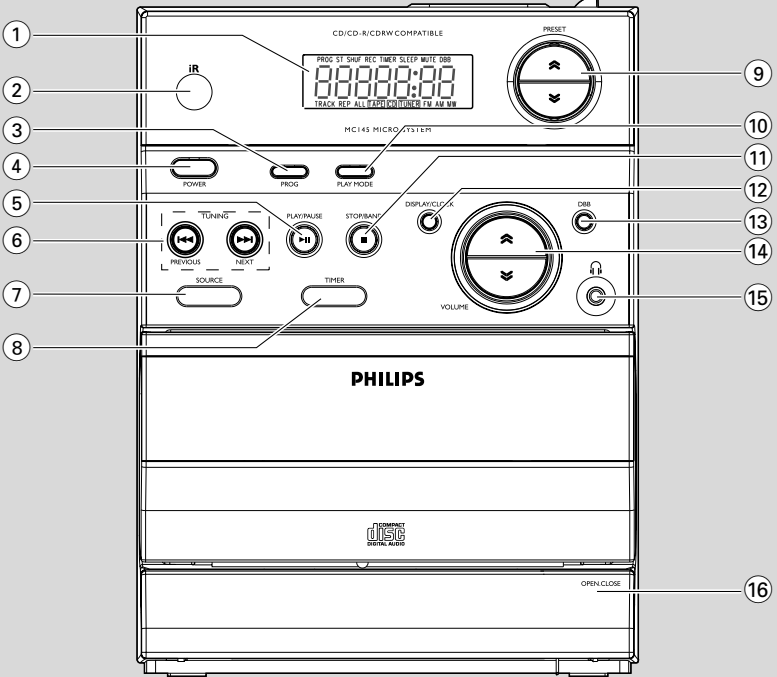
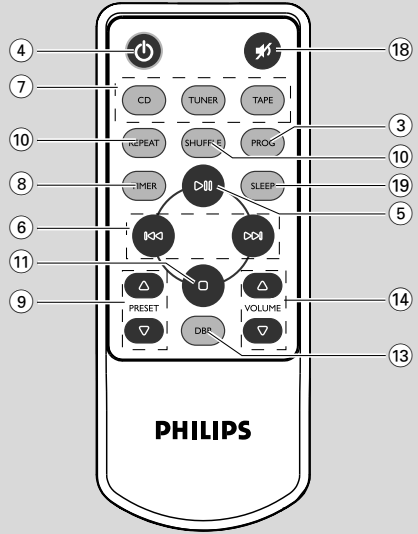
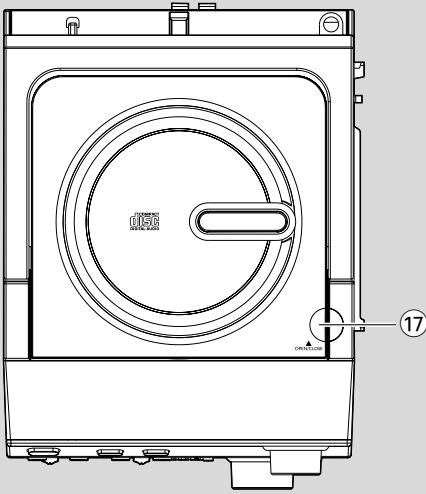

CAUTION

Use of controls or adjustments or performance of procedures other than herein may result in hazardous radiation exposure or other unsafe operation.

English 6

中文 21

Русский 36

English

中文

Русский

Contents

General Information

Environmental information	7
Supplied accessories	7
Safety information	7

Preparation

Rear connections	8-9
Before using the remote control	9
Replacing battery (lithium CR2032) into the remote control	9

Controls

Controls on the system and remote control	10
--	----

Basic Functions

Switching the system on	11
Power-saving automatic standby	11
Adjusting volume and sound	11

CD Operation

Playing a disc	12
Selecting a different track	12
Finding a passage within a track	12
Different play modes: Shuffle and Repeat	13
Programming track numbers	13
Reviewing the programme	13
Erasing the programme	13

Radio Reception

Tuning to radio stations	14
Programming radio stations	14
Tuning to preset radio stations	14

Tape Operation/Recording

Tape playback	15
General information on recording	15
Synchro start CD recording	15-16
Recording from the radio	16

Maintenance	16
-------------------	----

Clock/Timer

Setting the clock	17
Setting the timer	17
Activating and deactivating TIMER	17
Activating and deactivating SLEEP	17

Specifications	18
----------------------	----

Troubleshooting	19-20
-----------------------	-------

The making of unauthorized copies of copy-protected material, including computer programmes, files, broadcasts and sound recordings, may be an infringement of copyrights and constitute a criminal offence. This equipment should not be used for such purposes.



Be responsible
Respect copyrights

Supplied accessories

- 2 speaker boxes
- remote control with battery

Environmental Information

All unnecessary packaging has been omitted. We have tried to make the packaging easy to separate into three materials: cardboard (box), polystyrene foam (buffer) and polyethylene (bags, protective foam sheet).

Your system consists of materials which can be recycled and reused if disassembled by a specialized company. Please observe the local regulations regarding the disposal of packaging materials, exhausted batteries and old equipment.

Safety Information

- Before operating the system, check that the operating voltage indicated on the typeplate (or the voltage indication beside the voltage selector) of your system is identical with the voltage of your local power supply. If not, please consult your dealer.
- Place the system on a flat, hard and stable surface.
- Place the system in a location with adequate ventilation to prevent internal heat build-up in your system. Allow at least 10 cm (4 inches) clearance from the rear and the top of the unit and 5 cm (2 inches) from each side.
- The ventilation should not be impeded by covering the ventilation openings with items, such as newspapers, table-cloths, curtains, etc.
- Do not expose the system, batteries or discs to excessive moisture, rain, sand or heat sources caused by heating equipment or direct sunlight.
- No naked flame sources, such as lighted candles, should be placed on the apparatus.
- No objects filled with liquids, such as vases, shall be placed on the apparatus.
- If the system is brought directly from a cold to a warm location, or is placed in a very damp room, moisture may condense on the lens of the disc unit inside the system. Should this occur, the CD player would not operate normally. Leave the power on for about one hour with no disc in the system until normal playback is possible.
- The mechanical parts of the set contain self-lubricating bearings and must not be oiled or lubricated.
- **When the system is switched to Standby mode, it is still consuming some power. To disconnect the system from the power supply completely, remove the AC power plug from the wall socket.**

Preparations

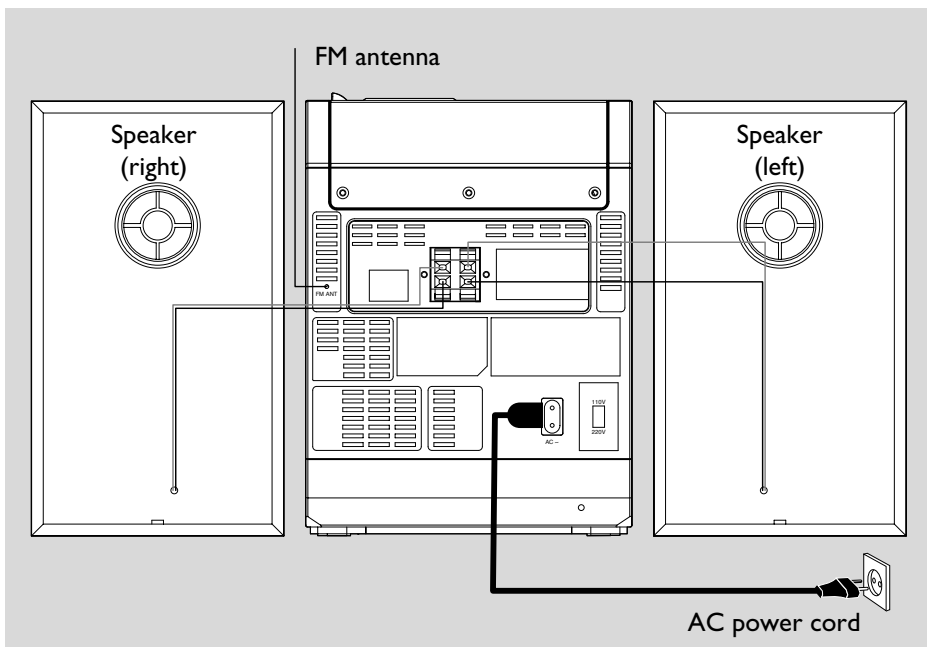

Rear connections

The type plate is located at the back of the system.

A Power

- Before connecting the AC power cord to the wall outlet, ensure that all other connections have been made.
- If your system is equipped with a Voltage Selector, set the VOLTAGE SELECTOR to the local power line voltage.

WARNING!

- For optimal performance, use only the original power cable.
- Never make or change any connections with the power switched on.

B Speakers Connection

Front Speakers

Connect the speaker wires to the SPEAKERS terminals, right speaker to "RIGHT" and left speaker to "LEFT", coloured (marked) wire to "+" and black (unmarked) wire to "–".

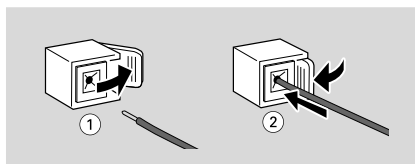

- Fully insert the stripped portion of the speaker wire into the terminal as shown.

Notes:

- For optimal sound performance, use the supplied speakers.
- Do not connect more than one speaker to any one pair of +/– speaker terminals.
- Do not connect speakers with an impedance lower than the speakers supplied. Please refer to the SPECIFICATIONS section of this manual.

Before using the remote control

- 1 Pull out the plastic protective sheet.
- 2 Select the source you wish to control by pressing one of the source select keys on the remote control (for example CD,TUNER).
- 3 Then select the desired function (for example ►, ◀, ▶).

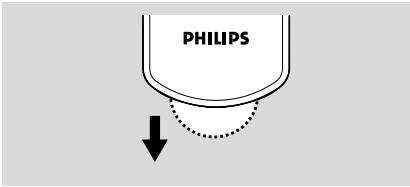

Replacing battery (lithium CR2032) into the remote control

- 1 Pull out the knob (A) slightly to the right.
- 2 Pull out the battery compartment (B) .
- 3 Replace a new battery and fully insert the battery compartment back to the original position.

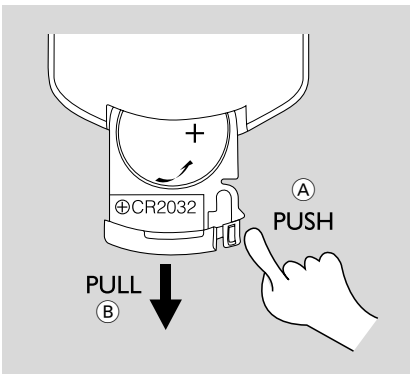

CAUTION!

Batteries contain chemical substances, so they should be disposed off properly.

Controls (illustrations on page 3)

Controls on the system and remote control

- ① **LCD Display**
 - shows the status of the system.
- ② **IR SENSOR**
 - infrared sensor for remote control.
- ③ **PROG**
 - for CD programs tracks and reviews the program.
 - for Tuner programs tuner stations manually or automatically.
- ④ **POWER / \odot**
 - switches the system to standby/on.
- ⑤ **PLAY/PAUSE \blacktriangleright \blacktriangleleft**
 - for CD starts or pauses CD playback.
- ⑥ **TUNING, PREVIOUS/NEXT (\blacktriangleleft \blacktriangleright)**
 - for CD skips to the beginning of a current track/previous/ next track.
 - fast searches back and forward within a track/CD.
 - for Tuner tunes to radio stations.
 - for clock/timer .. adjusts the hours and minutes for clock / timer functions
- ⑦ **SOURCE (CD/TUNER/TAPE)**
 - switches on the system.
 - selects the respective sound source for CD/ TUNER / TAPE.
- ⑧ **TIMER**
 - activates/deactivates or sets the timer function.
- ⑨ **PRESET \approx / \cong (Δ / ∇ on remote control)**
 - for Tuner selects a preset radio station.
- ⑩ **PLAYMODE (REPEAT / SHUFFLE)**
 - repeats a track/CD program/ entire CD.
 - plays CD tracks in random order.
- ⑪ **STOP/BAND \blacksquare**
 - for CD stops CD playback or erase a CD program.
 - for Tuner (on the set only) selects waveband.
- ⑫ **DISPLAY/CLOCK**
 - for CD display CD remaining time.
 - at standby sets the clock function.
- ⑬ **DBB (Dynamic Bass Boost)**
 - enhances the bass.
- ⑭ **VOLUME \approx / \cong (Δ / ∇ on remote control)**
 - adjusts volume level.
- ⑮ ****
 - connect headphones.
- ⑯ **Tape Deck Operation**
 - OPEN•CLOSE** ..Opens the tape key cover.
 - RECORD \bullet** starts recording.
 - PLAY \blacktriangleright** starts playback.
 - \blacktriangleleft / \blacktriangleright** fast rewinds/forwards the tape.
 - STOP•OPEN** ... stops the tape; opens the tape compartment.
 - PAUSE** pauses recording or playback.
- ⑰ **OPEN•CLOSE**
 - opens/closes the CD door.
- ⑱ **MUTE **
 - switches playback sound off and on.
- ⑲ **SLEEP**
 - activates/deactivates or selects the sleeper time.

Notes for remote control:

- **First select the source you wish to control by pressing one of the source select keys on the remote control (for example CD , TUNER).**
- **Then select the desired function (for example \blacktriangleright , \blacktriangleleft , \blacktriangleright).**

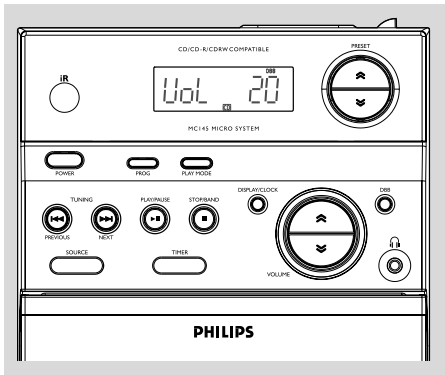

IMPORTANT:
Before you operate the system, complete the preparation procedures.

Switching the system on

- Press **POWER** (⏻ on the remote control) or **SOURCE**.
 → The system will switch to the last selected source.
- Press **SOURCE** (CD, TUNER or TAPE on the remote control).
 → The system will switch to the selected source.

To switch the system to standby mode

- Press **POWER** (⏻ on the remote control).
- If in tape mode or recording mode, press **STOP•OPEN** first.
 → The volume level (up to maximum volume level of 20), interactive sound settings, last selected source and tuner presets will be retained in the player's memory.

Power-saving automatic standby

The power-saving feature automatically switches to standby 15 minutes after a tape or CD playback has ended and no control is operated.

Adjusting volume and sound

- 1 Press **VOLUME** \approx / \approx (Δ / ∇ on remote control) to increase or decrease volume.
 → Display shows the volume level **Vol** and a number from 0-32.
- 2 Press **DBB** to switch bass enhancement on or off.
 → Display shows: **DBB** if the DBB is activated.
- 3 Press **MUTE** 🔇 on the remote control to stop sound play-back instantly.
 → Playback will continue without sound and the display shows **MUTE**.

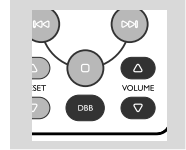

- To start sound playback you can:
 - press **MUTE** 🔇 again;
 - adjust the volume controls;
 - change source.

CD Operation

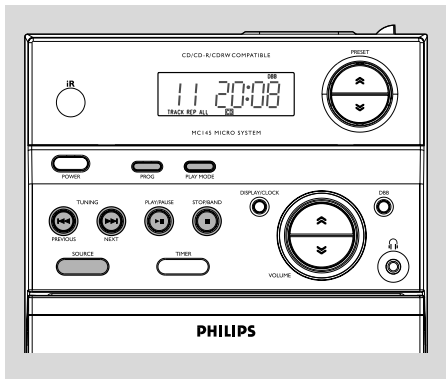

IMPORTANT:

The lens of the CD player should never be touched.

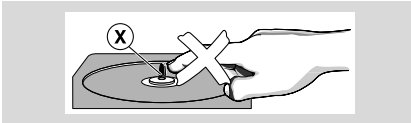

Playing a disc

This CD player plays Audio Discs including CD-Recordables and CD-Rewritables.

- CD-ROM, CD-I, CDV, VCD, DVD or computer CDs, however, are not possible.

- 1 Select **CD** source.
- 2 Lift the disc door at the edge marked **OPEN•CLOSE** to open the CD compartment.
→ *OPEN* is displayed when you open the CD compartment.

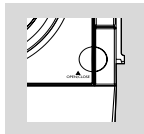

- 3 Insert a disc with the printed side facing up and press down on **OPEN•CLOSE** to close the CD door:
→ *READ* is displayed as the CD player scans the contents of a disc. The total number of tracks and the total playing time are also shown.

- 4 Press **▶▶** to start playback.
→ Current track number followed by elapsed playing time of the track are displayed during disc playback.
→ Press **DISPLAY/CLOCK** to display total remain playing time.

- 5 To pause playback press **▶▶**. Press **▶▶** again to resume play.
→ Display: The elapsed time flashes when playback is paused.

- 6 To stop disc playback, press **■**.

Note: CD play will also stop when;

- the CD door is opened.
- the disc has reached the end.
- you select another source: **TAPE, TUNER**.
- you select standby.
- you press the tape deck **PLAY ▶** key.

Selecting a different track

- Press **◀◀** or **▶▶** once or repeatedly until the desired track number appears in the display.
- Press **▶▶** to start playback.

Finding a passage within a track

- 1 Press and hold down **◀◀** or **▶▶**.
→ The disc is played at high speed and low volume.
- 2 When you find the passage you want, release **◀◀** or **▶▶**.
→ Normal playback continues.

Different play modes: SHUFFLE and REPEAT

You can select and change the various play modes before or during playback.

REPEATplays the current track continuously

REPEAT ALL ... repeats the entire disc/ programme

SHUFFLEtracks of the entire disc are played in random order

- 1** To select your play mode, press **PLAYMODE (SHUFFLE or REPEAT)** on the remote control) before or during playback until the display shows the desired function.
- 2** Press **▶||** to start playback if in the STOP position.
→ If you have selected SHUFFLE, playback starts automatically.
- 3** To return to normal playback, press **PLAYMODE (SHUFFLE or REPEAT)** on the remote control) until the various SHUFFLE/ REPEAT modes are no longer displayed.
- You can also press **STOP ■** to cancel your play mode.

Programming track numbers

Programme in the STOP position to select and store your disc tracks in the desired sequence. If you like, store any track more than once. Up to 20 tracks can be stored in the memory.

- 1** Press **◀◀** or **▶▶** to select your desired track number.
- 2** Press **PROG.**
→ Display shows; the selected track number. **PROG** flashes and *! PR* appears briefly.
- 3** Repeat steps **1-2** to select and store all desired tracks.
→ *FFFF* is displayed if you attempt to programme more than 20 tracks.
- 4** To start playback of your disc programme, press **▶||**.

Notes:

- *If you wish, you can add further tracks to your current program. Make sure you are in the STOP position, and that you have not exceeded 20 tracks.*
- *Display shows NOSE if there is no track selected.*

Erasing the programme

You can erase the programme by:

- pressing **■** once in the STOP mode;
- pressing **■** twice during playback;
- opening the CD compartment;
- Select another sound source
→ **PROG** disappears from the display.

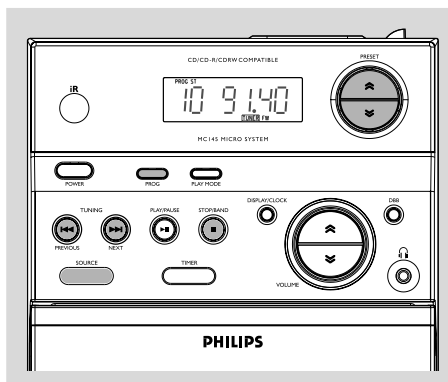

Tuning to radio stations

- 1 Select **TUNER** source.
→ **TUNER** is displayed.
- 2 Press **STOP/BAND** (on the set) or **TUNER** (on the remote control) once or more to select your waveband.
- 3 Press on **TUNING** **◀◀** or **▶▶** and release button.
→ The radio automatically tunes to a station with sufficient reception. Display indication during automatic tuning *5 r c h*.
- 4 Repeat step 3 if necessary until you find the desired station.
- To tune to a weak station, press **TUNING** **◀◀** or **▶▶** briefly and repeatedly until you have found optimal reception.

Helpful hints:

To improve radio reception:

- For **FM**, extend coil antenna at the back of the unit fully for optimum reception.
- For **MW**, the set uses a built-in antenna. Direct this antenna for best reception by turning the whole set.

Programming radio stations

You can store up to a total of 20 (10 FM and 10 MW) radio stations in the memory.

Automatic programming

Automatic programming will start with a chosen preset number 1. From this preset number upwards, former programmed radio stations will be overridden.

- 1 Press **STOP/BAND** (on the set) or **TUNER** (on the remote control) once or more to select your waveband.
 - 2 Press **PRESET** \approx / \cong (Δ / ∇ on remote control) to select the preset number where programming should start.
- Note:**
– If no preset number is selected, default is preset (1) and all your presets will be overridden.
- 3 Press **PROG** for more than 2 seconds to activate programming.
→ *RLÉ* is displayed and available stations are programmed in order of waveband reception strength.

Manual programming

- 1 Tune to your desired station (see Tuning to radio stations).
 - 2 Press **PROG** to activate programming.
→ **PROG** flashes in the display.
 - 3 Press **PRESET** \approx / \cong (Δ / ∇ on remote control) to select a number from 1 to 10 for FM (or 1 to 10 for MW) to this station.
 - 4 Press **PROG** again to confirm the setting.
→ **PROG**, the preset number and the frequency of the preset station is shown.
 - 5 Repeat the above four steps to store other stations.
- You can override a preset station by storing another frequency in its place.

Tuning to preset radio stations

- Press **PRESET** \approx / \cong (Δ / ∇ on remote control) until the desired preset station is displayed.

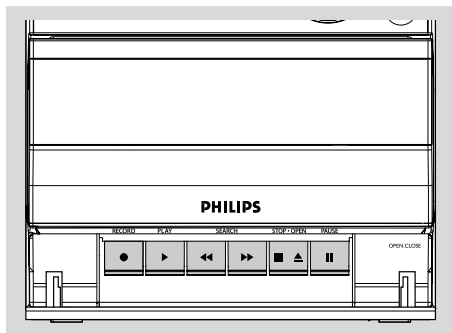

Tape playback

- 1 Select **TAPE** source.
→ Display: shows **TAPE** throughout tape operation.
- 2 Pull down the plate marked "**OPEN•CLOSE**" at the bottom of the main set.
- 3 Press **STOP•OPEN** ■ ▲ to open the tape door.
- 4 Insert a recorded tape and close the tape door.
- Load the tape with the open side downward and the full spool to the left.
- 5 Press **PLAY** ► to start playback.
- 6 To pause, press **PAUSE** ■■. Press again to resume.
- 7 Press ◀◀ or ▶▶ to fast wind tape in either direction.
- 8 To stop the tape, press **STOP•OPEN** ■ ▲.

Notes:

- During playback, the keys are automatically released at the end of a tape. To switch off the set, press **POWER**.
- During fast forwarding/rewinding, the keys will not be released at the end of a tape. To stop fast winding, press **STOP/EJECT** ■▲.
- The sound source cannot be changed while playing and recording a tape.

General information on recording

- Recording is permissible insofar as copyright or other rights of third parties are not infringed.
- For recording, use only **NORMAL** (IEC type I) tapes on which the tabs have not yet been broken. This deck is not suited for recording on **METAL** (IEC IV) type tapes.
- The best recording level is set automatically. Altering the **VOLUME** or **DBB** controls will not affect the recording in progress.
- The recording sound quality might differ depending on the quality of your recording source and the recording tape.
- At the very beginning and end of the tape, no recording will take place during the 7 seconds when the leader tape passes the recorder heads.
- To protect a tape from accidental erasure, have the tape in front of you and break out the left tab. Recording on this side is no longer possible. If, however, you wish to record over this side again, cover the tabs with a piece of adhesive tape.

Synchro start CD recording

- 1 Select **CD** source.
- 2 Insert a disc and if desired, programme track numbers.
- 3 Press **STOP•OPEN** ■ ▲ to open the tape door.
- 4 Insert a suitable tape into the deck and close the tape door.
- 5 Press **RECORD** ● to start recording.
→ Playing of the CD programme starts automatically from the beginning of the CD after 7 seconds. It is not necessary to start the CD player separately.

Tape Operation / Recording

To select and record a particular passage within a CD track:

- Press and hold down on ◀◀ or ▶▶. Release the control when you recognize the passage you want.
 - To interrupt CD playback press ▶▶.
 - Recording starts from this exact point in the track when you press **RECORD ●**.
- 6 To pause, press **PAUSE II**. Press again to resume.
 - 7 To stop recording, press **STOP•OPEN**.

Recording from the radio

- 1 Tune to the desired radio station (see Tuning to radio stations).
- 2 Press **STOP•OPEN ■ ▲** to open the tape door.
- 3 Insert a suitable tape into the deck and close the tape door.
- 4 Press **RECORD ●** to start recording.
- 5 To pause, press **PAUSE II**. Press again to resume.
- 6 To stop recording, press **STOP•OPEN ■ ▲**.

Maintenance

Cleaning the Cabinet

- Use a soft cloth slightly moistened with a mild detergent solution. Do not use a solution containing alcohol, spirits, ammonia or abrasives.

Cleaning Discs

- When a disc becomes dirty, clean it with a cleaning cloth. Wipe the disc from the centre out.
- Do not use solvents such as benzene, thinner, commercially available cleaners, or antistatic spray intended for analogue records.



Cleaning the disc lens

- After prolonged use, dirt or dust may accumulate at the disc lens. To ensure good playback quality, clean the disc lens with Philips CD Lens Cleaner or any commercially available cleaner. Follow the instructions supplied with cleaner.

Cleaning the Heads and the Tape Paths

- To ensure good recording and playback quality, clean the heads (A), the capstan(s) (B), and pressure roller(s) (C) after every 50 hours of tape operation.
- Use a cotton swab slightly moistened with cleaning fluid or alcohol.
- You can also clean the heads by playing a cleaning tape once.

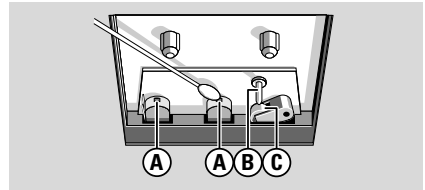

Demagnetising the heads

- Use a demagnetising tape available at your dealer.

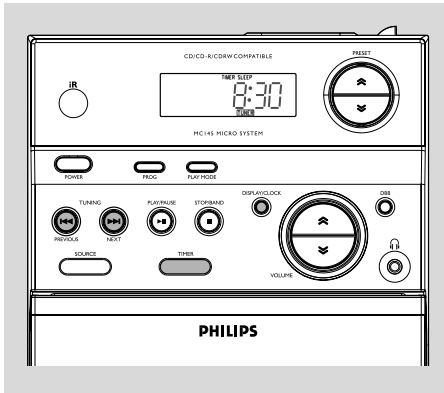

Setting the clock

- 1 In Standby mode, press **DISPLAY/CLOCK** button.
→ The clock digits for the hours flash.
- 2 Press **◀▶** to set the hours.
- 3 Press **DISPLAY/CLOCK** again.
→ The clock digits for the minutes flash.
- 4 Press **◀▶** to set the minutes.
- 5 Press **DISPLAY/CLOCK** to confirm the time.

Note:

– If the clock has not been set, -- will be displayed.

Setting the timer

- The system can be used as an alarm clock. CD or TUNER can be set to switch on at a preset time. The clock time needs to be set first before the timer can be used.
- If no button is pressed within 90 seconds during timer setup, the system will exit timer setting mode automatically.

- 1 In any mode, press **TIMER** for more than 2 seconds.
- 2 Press **◀▶** (**CD / TUNER** or **◀▶** on the remote control) to select sound source.
- 3 Press **TIMER** to confirm your desired source.
→ The clock digits for the hours flash.
- 4 Press **◀▶** to set the hours.
- 5 Press **TIMER** again.
→ The clock digits for the minutes flash.
- 6 Press **◀▶** to set the minutes.
- 7 Press **TIMER** to confirm the time.
→ The timer is now set and actiated.

Note:

– If source CD is selected and no disc is in the CD tray or the disc has an error, TUNER will be selected automatically.

Activating and deactivating TIMER

- In standby or during playback, press **TIMER** once.
→ Display shows **TIMER** if activated, and disappears if deactivated.

Activating and deactivating SLEEP

The sleep timer enables the system to switch off by itself after a set period of time.

- Press **SLEEP** on the remote control repeatedly to select desired time before system shuts off.

→ Display shows **SLEEP** and series of time options for selection: 60, 45, 30, 15, 0, 60.

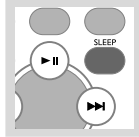

- To deactivate, press **SLEEP** on the remote control once or more until '0' is shown, or press **POWER** / \odot on the system or remote control.

Specifications

AMPLIFIER

Output power 2 x 2 W RMS
..... 200W PMPO
Signal-to-noise ratio \geq 62 dBA (IEC)
Frequency response 63 – 16000 Hz, \pm 3 dB
Impedance loudspeakers 8 Ω
Impedance headphones 32 Ω – 1000 Ω

CD PLAYER

Frequency range 63 – 16000 Hz
Signal-to-noise ratio 65 dBA

TUNER

FM wave range 87.5 – 108 MHz
MW wave range 531 – 1602 kHz

TAPE DECK

Frequency response
Normal tape (type I) 125 – 8000 Hz (8 dB)
Signal-to-noise ratio
Normal tape (type I) 34 dBA
Wow and flutter \leq 0.4% DIN

SPEAKERS

Bass reflex system
Dimensions (w x h x d)
..... 130 x 224.5 x 213 (mm)

GENERAL INFORMATION

AC Power 220 – 240 V / 50 Hz
Dimensions (w x h x d)
..... 168 x 224.5 x 214.5 (mm)
Weight (with/without speakers)
..... approx. 4.6 / 2.25 kg
Standby power consumption < 3 W

Subject to modification

WARNING

Under no circumstances should you try to repair the system yourself, as this will invalidate the warranty. Do not open the system as there is a risk of electric shock.

If a fault occurs, first check the points listed below before taking the system for repair. If you are unable to remedy a problem by following these hints, consult your dealer or service centre.

Problem	Solution
CD OPERATION	
"no cd" is displayed.	<ul style="list-style-type: none"> – Insert a disc. – Check if the disc is inserted upside down. – Wait until the moisture condensation at the lens has cleared. – Replace or clean the disc, see "Maintenance". – Use a finalised CD-RW or CD-R.
RADIO RECEPTION	
Radio reception is poor.	<ul style="list-style-type: none"> – If the signal is too weak, adjust the antenna or connect an external antenna for better reception. – Increase the distance between the Micro HiFi System and your TV or VCR.
TAPE OPERATION / RECORDING	
Recording or playback cannot be made.	<ul style="list-style-type: none"> – Clean deck parts, see "Maintenance". – Use only normal (IEC I) tape for recording. – Apply a piece of adhesive tape over the missing tab space.
GENERAL	
The system does not react when buttons are pressed.	<ul style="list-style-type: none"> – Remove and reconnect the AC power plug and switch on the system again.
Sound cannot be heard or is of poor quality.	<ul style="list-style-type: none"> – Adjust the volume. – Disconnect the headphones. – Check that the speakers are connected correctly. – Check if the stripped speaker wire is clamped.
The left and right sound outputs are reversed.	<ul style="list-style-type: none"> – Check the speaker connections and location.

Troubleshooting

The remote control does not function properly.

- Select the source (CD or TUNER, for example) before pressing the function button (▶, ◀, ▶).
 - Reduce the distance between the remote control and the system.
 - Insert the batteries with their polarities (+/- signs) aligned as indicated.
 - Replace the batteries.
 - Point the remote control directly toward IR sensor on the front of the system.
-

The timer is not working.

- Set the clock correctly.
 - Press **TIMER** to switch on the timer.
 - If a recording is in progress, stop the recording.
-

The Clock/Timer setting is erased.

- Power has been interrupted or the power cord has been disconnected. Reset the clock/timer.
-