

Micro HIFI System

MC 118



Let's make things better.



PHILIPS

INDEX

English	English	4
Français	Français	14
Español	Español	24
Deutsch	Deutsch	34
Nederlands	Nederlands.....	44
Italiano	Italiano.....	54
Português	Português	64
Dansk	Dansk	74
Svenska	Svenska	84
Suomi	Suomi	94
Ελληνικά	Έλληνικά	104

Important notes for users in the U.K.**Mains plug**

This apparatus is fitted with an approved moulded 13 Amp plug. To change a fuse in this type of plug proceed as follows:

- 1 Remove fuse cover and fuse.
- 2 Fix new fuse which should be a BS1362 5 Amp, A.S.T.A. or BSI approved type.
- 3 Refit the fuse cover.

If the fitted plug is not suitable for your socket outlets, it should be cut off and an appropriate plug fitted in its place.

If the mains plug contains a fuse, this should have a value of 5 Amp. If a plug without a fuse is used, the fuse at the distribution board should not be greater than 5 Amp.

Note: The severed plug must be disposed to avoid a possible shock hazard should it be inserted into a 13 Amp socket elsewhere.

How to connect a plug

The wires in the mains lead are coloured with the following code: blue = neutral (N), brown = live (L). As these colours may not correspond with the colour markings identifying the terminals in your plug, proceed as follows:

- Connect the blue wire to the terminal marked N or coloured black.
- Connect the brown wire to the terminal marked L or coloured red.
- Do not connect either wire to the earth terminal in the plug, marked E (or \perp) or coloured green (or green and yellow).

Before replacing the plug cover, make certain that the cord grip is clamped over the sheath of the lead - not simply over the two wires. Copyright in the U.K.: Recording and playback of material may require consent. See Copyright Act 1956 and The Performer's Protection Acts 1958 to 1972.

(N) Norge

Typeskilt finnes på apparatens underside.

Observer: Nettbryteren er sekundert innkopleet. Den innebygde nettdelen er derfor ikke frakopleet nettet så lenge apparatet er tilsluttet nettkontakten.

For å redusere faren for brann eller elektrisk støt; skal apparatet ikke utsettes for regn eller fuktighet.

(I) Italia**DICHIARAZIONE DI CONFORMITA'**

Si dichiara che l'apparecchio MC 118 Philips risponde alle prescrizioni dell'art. 2 comma 1 del D. M. 28 Agosto 1995 n. 548.

Fatto a Eindhoven, il 27-09-1999

Philips Consumer Electronics
Philips, Glaslaan 2
5616 JB Eindhoven, The Netherlands

CONTROLS AND CONNECTIONS

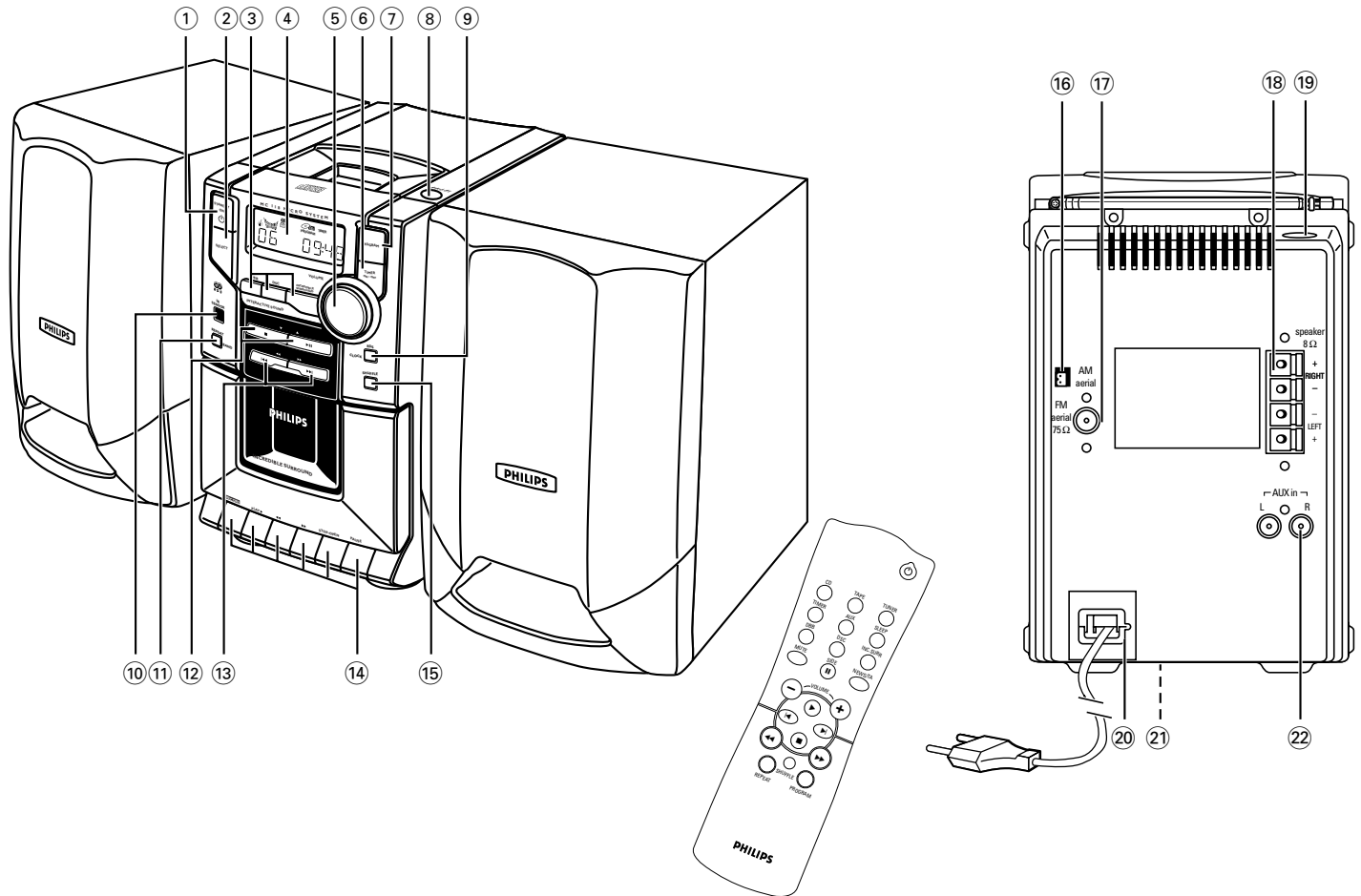

CONTROLS AND CONNECTIONS

Top and front panels

- ① STANDBY ON \odot . switches the set to standby/on
- ② SELECT SOURCE . selects the sound source for CD/ TUNER/ TAPE / AUX; switches on the set
- ③ **INTERACTIVE SOUND controls:**
- DBB (Dynamic Bass Boost) enhances the bass
- DSC (Digital Sound Control) selects sound characteristics: **OPTIMAL/ROCK/JAZZ/POP**
- INCREDIBLE SURROUND creates a super-enhanced stereo effect
- ④ Display shows the status of the set
- ⑤ VOLUME adjusts the volume level; adjusts the hour and minutes for the clock/ timer functions
- ⑥ TIMER ON • OFF activates, sets and deactivates the timer function
- ⑦ PROGRAM
- CD:** programmes tracks and reviews the programme;
- Tuner:** programmes tuner stations manually or automatically
- ⑧ OPEN • CLOSE opens/ closes the CD door
- ⑨ RDS / CLOCK displays RDS information; sets the clock function
- ⑩ iR SENSOR infrared sensor for remote control
- ⑪ REPEAT/BAND
- CD:** repeats a track/CD programme/ entire CD
- Tuner:** selects waveband;
- ⑫ PRESET \blacktriangledown selects a preset tuner station (down)
- STOP \blacksquare stops CD playback or erase a CD programme

- PRESET \blacktriangle selects a preset tuner station (up);
- PLAY • PAUSE \blacksquare starts or interrupts CD play
- ⑬ TUNING $\blacktriangleleft, \blacktriangleright$ (down, up) tunes to radio stations;
- PREV \blacktriangleleft ,
NEXT \blacktriangleright searches back and forward within a CD track; skips to the beginning of a current track/ previous/ subsequent track
- ⑭ **CASSETTE RECORDER keys:**
- RECORD starts recording
- PLAY \blacktriangleright starts playback
- $\blacktriangleleft, \blacktriangleright$ fast rewinds/winds the tape
- STOP • OPEN stops the tape; opens the cassette compartment
- PAUSE interrupts recording or playback
- ⑮ SHUFFLE plays CD tracks in random order

Back panel

- ⑯ AM AERIAL connect the supplied AM frame aerial here
- ⑰ FM AERIAL 75 Ω connect the supplied aerial wire or an antenna wall connection here
- ⑱ SPEAKERS 8 Ω connect the supplied speakers here
- ⑲ H 3.5 mm stereo headphone socket
- ⑳ AC MAINS after all other connections have been made, connect the mains lead to the wall socket.
- ㉑ Voltage selector *on the bottom of the set on some versions only*
- ㉒ AUX IN connect to the audio output of an additional appliance

Remote control

- \odot switches the set to standby
- CD, TAPE, TUNER, AUX selects the respective sound source
- TIMER activates and deactivates the timer

- SLEEP activates and deactivates the sleeper time; selects sleeper time
- DBB (Dynamic Bass Boost) enhances the bass
- DSC (Digital Sound Control) selects sound characteristics: **OPTIMAL/ROCK/JAZZ/POP**
- INCR.SURR creates a super-enhanced stereo effect
- MUTE interrupts and resumes sound reproduction
- SIDE/ \parallel interrupts CD playback
- NEWS/TA activates RDS news and Traffic Announcement (*not all versions*)
- VOLUME $-$, $+$ adjusts volume level
- \blacktriangleright starts CD playback
- $\blacktriangleleft, \blacktriangleright$ **CD:** skips to the beginning of a current track/ previous/ subsequent track; **Tuner:** (down, up) selects a preset radio station
- \blacksquare stops CD playback or erases a CD programme
- $\blacktriangleleft, \blacktriangleright$ **CD:** searches backwards or forwards within a track/CD **Tuner:** (down, up) tunes to radio stations
- REPEAT repeats a track/ CD programme/ entire CD
- SHUFFLE to play CD tracks in random order
- PROGRAM **CD:** programmes tracks and reviews the programme; **Tuner:** programmes radio stations or starts Auto programming.

Note: select the desired sound source first (e.g. CD), then press the required function key (e.g. \blacktriangleright).

GENERAL INFORMATION

Supplied Accessories

- 2 speaker boxes
- remote control with batteries
- AM/MW frame aerial
- FM aerial wire

General maintenance

- Do not expose the set, batteries, CDs or cassettes to humidity, rain, sand or excessive heat caused by heating equipment or direct sunlight.

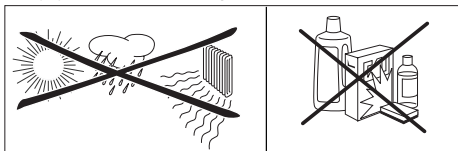

- To clean the set, use a soft, slightly dampened chamois leather. Do not use any cleaning agents containing alcohol, ammonia, benzene or abrasives as these may harm the housing.

Environmental information

All unnecessary packaging material has been omitted. We have done our utmost to make the packaging easy to separate into three mono-materials: cardboard (box), expandable polystyrene (buffer), polyethylene (bags, protective foam).

Your set consists of materials which can be recycled if disassembled by a specialized company. **Please observe the local regulations regarding the disposal of packing materials, exhausted batteries and old equipment.**

POWER SUPPLY

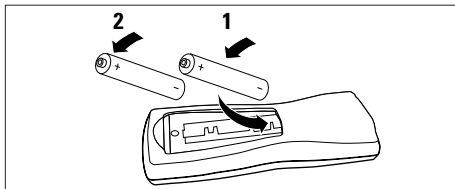

Batteries for the remote control

- Open the battery compartment and insert two batteries, type **AA, R06** or **UM3** (preferably alkaline) with the correct polarity as indicated by the + and – symbols inside the compartment.

Important! Remove the batteries if they are flat or if the unit is not to be used for a long time.

Batteries contain chemical substances, so they should be disposed of properly.

Speaker connections

The speaker terminals are click-fit connectors. Use them as shown below.

- Connect the unmarked wire to the red terminal and the marked black wire to the black terminal.
- When headphones are inserted into the headphone socket the speakers are disconnected.

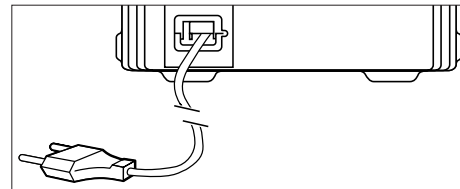
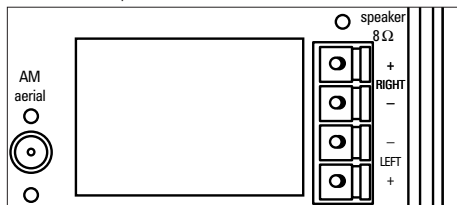

Mains

- 1 Check if the mains voltage, as shown on the **type plate located on the back of the set**, corresponds to your local mains voltage. If it does not, consult your dealer or service centre.
 - 2 If your set is equipped with a voltage selector, adjust the selector so that it matches with the local mains.
 - 3 Connect the mains lead to the wall socket and the set is now ready for use.
 - 4 To disconnect the set from the mains completely, remove the plug from the wall socket.
- For users in the UK, please follow the instructions on page 2.*

POWER-SAVING AUTOMATIC STANDBY

As a power-saving feature, the unit automatically switches to standby 15 minutes after a tape or CD has reached the end and no control is operated.

Safety information

- Place the set on a hard and flat surface so that the system does not tilt. Make sure there is adequate ventilation to prevent the system from overheating.
- The mechanical parts of the set contain self-lubricating bearings and must not be oiled or lubricated.

This set complies with the radio interference requirements of the EU.

BASIC FUNCTIONS

English

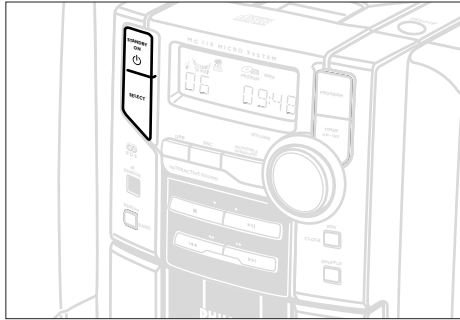

Switching on





There are 3 ways to switch the set on:

- press **STANDBY ON** on the set and the last selected source switches on;
- press **SELECT SOURCE** on the set and the last selected source switches on;
- press **CD, TUNER, TAPE** or **AUX** on the remote control.

To switch the set to standby, press **STANDBY ON** once on the set (**STANDBY ON** on the remote control).

- If in tape mode, press **STOP • OPEN** first
- The volume level, interactive sound settings, last selected source and tuner presets will be retained in the set's memory.

Adjusting volume and sound

- 1 Turn the **VOLUME** control anti-clockwise to decrease or clockwise to increase volume on the set (or press **VOLUME -**, **+** on the remote control).
→ Display shows the volume level **VOL** and a number from 0-32.
- 2 Press the Interactive sound control, **DSC** on the set or remote control once or more to select the desired sound effect: **OPTIMAL** (no indication) / **ROCK** () / **JAZZ** () / **POP** () / **OPTIMAL**....
- 3 Press **DBB** to switch bass enhancement on or off.
→ Display shows: **DBB** if the DBB is activated.
- 4 Press **INCREDIBLE SURROUND** (**INC. SURR.** On the remote control) to switch the surround sound effect on or off.
→ Display shows:  if activated

Note: The effect of INCREDIBLE SURROUND may vary with different types of music.

- 5 Press **MUTE** on the remote control to interrupt sound reproduction instantly.
– Playback will be continued without sound and the display shows **MUTE**.
 - To reactivate sound reproduction you can:
 - press **MUTE** again;
 - adjust the volume controls

CLOCK



Setting the clock

There are two possible methods for setting the clock: manually or automatically by using RDS.

Automatic clock setting (RDS versions only)

- 1 Tune to a RDS station (see **DIGITAL TUNER**).
- 2 Press **RDS/ CLOCK** for 2 seconds or more.
→ **SEARCH RDS TIME** is displayed for a maximum of 90 seconds; the time is then displayed.
→ **NO RDS TIME** is displayed if no time signal has been received and you will have to set the clock manually.

Manual clock setting

- 1 In standby, press **RDS/ CLOCK**.
→ The clock digits for the hours flash.
- 2 Turn **VOLUME** to set the hours: clockwise for hours up; anti-clockwise for hours down.
- 3 Press **RDS/ CLOCK** again.
→ The clock digits for the minutes flash.
- 4 Turn **VOLUME** to set the minutes: clockwise for minutes up; anti-clockwise for minutes down.
- 5 Press **RDS/ CLOCK** to confirm the time.

TIMER, SLEEP



Setting TIMER

- The unit can be used as an alarm clock, whereby the CD or tuner is switched on at a set time. The clock time needs to be set first before the timer can be used.
 - During setting, if more than 90 seconds elapses without a button being pressed the unit quits the timer setting mode.
- 1 In any mode, press **TIMER ON•OFF** for 2 seconds or more.
 - 2 Turn **VOLUME** clockwise (or press **SELECT SOURCE**) to select one of two sound sources.
 - 3 Press **TIMER ON•OFF** to confirm.
 - The selected source **CD** or **TUNER** is shown. Display sequence shows **CD**, **TUNER** and **TIMER** flashes. The clock digits for the hours flash.
 - 4 Turn **VOLUME** to set the hours: clockwise for hours up; anti-clockwise for hours down.
 - 5 Press **TIMER ON•OFF** again.
 - The clock digits for the minutes flash.
 - 6 Turn **VOLUME** to set the minutes: clockwise for minutes up; anti-clockwise for minutes down.
 - 7 Press **TIMER ON•OFF** to confirm the time.
 - The timer is now set and activated.

Activating and deactivating TIMER

- In standby or during playback, press **TIMER ON•OFF** on the set once (**TIMER** on the remote control).
 - Display shows **TIMER** if activated, and disappears if deactivated.

Activating and deactivating SLEEP

The sleep timer enables the unit to switch off by itself after a set period of time. The clock time needs to be set first before the sleep timer can be used.

- During playback to select and activate your desired sleep time, press **SLEEP** on the remote control once or more.
 - Display shows **SLEEP** and one of the sleep time options in sequence: **60, 45, 30, 15, SLEEP OFF, 60...** if you have selected a time. Once **SLEEP** is activated, **SLEEP ON** scrolls across the display at repeated intervals.
- To deactivate, press **SLEEP** on the remote control once or more until **SLEEP OFF** is shown, or press to standby on the set or remote control.
 - **SLEEP OFF** scrolls across the display.

CD PLAYER

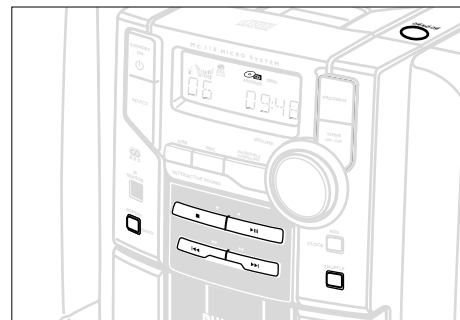

Playing a CD

This CD player plays Audio Discs including CD-Recordables and CD-Rewritables.

- CD-ROM, CD-I, CDV, VCD, DVD or computer CDs, however, are not possible.
- 1 Select CD source.
 - 2 Press **OPEN•CLOSE** to open the CD player compartment.
 - **OPEN** is displayed when you open the CD compartment.
 - 3 Insert a CD with the printed side facing up and press down on **OPEN•CLOSE** to close the CD door.
 - **REFF** is displayed as the CD player scans the contents of a CD, and then the total number of tracks and playing time are shown.
 - 4 Press **PLAY•PAUSE** **▶||** (on the remote control **▶**) to start playback.
 - Current track number and elapsed playing time of the track are displayed during CD playback.

- 5** To interrupt playback press **PLAY•PAUSE** **▶||** (on the remote control **SIDE/||**). Press **PLAY•PAUSE** **▶||** (on the remote control **▶**) again to resume play.
→ The display freezes and the elapsed playing time flashes when playback is interrupted.
- 6** To stop CD playback, press **STOP** **■**.

Note: CD play will also stop when:

- the CD door is opened
- the CD has reached the end
- you select another source: **TAPE**, **TUNER** or **AUX**
- you press to standby
- you press the tape deck **PLAY▶** key

Selecting a different track

- Press **PREV** **◀◀** or **NEXT** **▶▶** on the set, (on the remote control **◀** or **▶**) once or repeatedly until the desired track number appears in the display.
- If you have selected a track number shortly after loading a CD or in the **PAUSE** position, you will need to press **PLAY•PAUSE** **▶||** (on the remote control **▶**) to start playback.

Finding a passage within a track

- 1** Press and hold down on **PREV** **◀◀** or **NEXT** **▶▶**.
– The CD is played at high speed and low volume.
- 2** When you recognize the passage you want, release **PREV** **◀◀** or **NEXT** **▶▶**.
– Normal playback continues.

Note: During a CD program or if SHUFFLE/ REPEAT active, searching is only possible within the same track.

Different play modes: SHUFFLE and REPEAT

You can select and change the various play modes before or during playback. The play modes can also be combined with **PROGRAM**.

SHUFFLE tracks of the entire CD/ programme are played in random order

SHUFFLE and **REPEAT ALL** to repeat the entire CD/ programme continuously in random order

REPEAT ALL repeats the entire CD/ programme

REPEAT plays the current track continuously

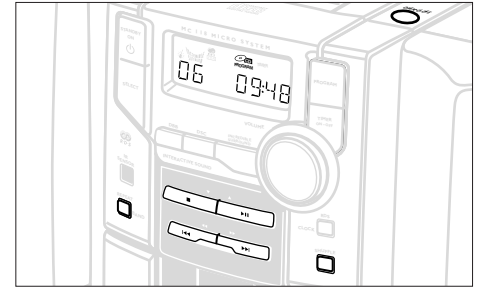

- 1** To select your play mode, press the **SHUFFLE** or **REPEAT** button before or during playback until the display shows the desired function.
- 2** Press **PLAY•PAUSE** **▶||** (on the remote control **▶**) to start playback if in the **STOP** position.
→ If you have selected **SHUFFLE**, playback starts automatically.
- 3** To return to normal playback, press the respective **SHUFFLE** or **REPEAT** button until the various **SHUFFLE/ REPEAT** modes are no longer displayed.
– You can also press **STOP** **■** to cancel your play mode.



Programming track numbers

Programme in the **STOP** position to select and store your CD tracks in the desired sequence. If you like, store any track more than once. Up to 20 tracks can be stored in the memory.

- 1** Press **PROGRAM** on the set or remote control to enter the programming mode.
→ A track number is shown and **PROGRAM** flashes.
- 2** Use the **PREV** **◀◀** or **NEXT** **▶▶** on the set, (on the remote control **◀** or **▶**) to select your desired track number.
- 3** Press **PROGRAM** to confirm the track number to be stored.
→ The number of tracks programmed and total playing time of the programme is shown briefly, then the selected track and **PROG**.
- 4** Repeat steps **2-3** to select and store all desired tracks.
→ **FULL** is displayed if you attempt to programme more than 20 tracks.



- 5 To start playback of your CD programme, press **PLAY•PAUSE**  (on the remote control .

Reviewing the programme

- In **STOP** mode, press and hold down **PROGRAM** on the set or remote control, for a while until the display shows all your stored track numbers in sequence.

Erasing a programme

You can erase the programme by:

- pressing **STOP**  once in the **STOP** position;
- pressing **STOP**  twice during playback;
- pressing the CD door open;

- PROGRAM** disappears from the display.

CD player and CD handling

- If the CD player cannot read CDs correctly, use a commonly available cleaning CD to clean the lens before taking the set to repair. Other cleaning methods may destroy the lens.
- The lens of the CD player should never be touched!

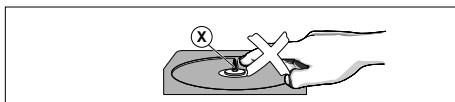

- Sudden changes in the surrounding temperature can cause condensation to cloud over on the lens of your CD player. Playing a CD is then not possible. Do not attempt to clean the lens but leave the set in a warm environment until the moisture evaporates.
- Always keep the CD compartment closed to avoid dust on the lens.
- To take a CD out of its box, press the centre spindle while lifting the CD. Always pick up the CD by the edge and return the CD to its box after use to avoid scratching and dust.

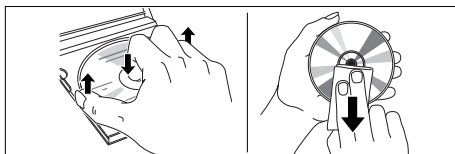



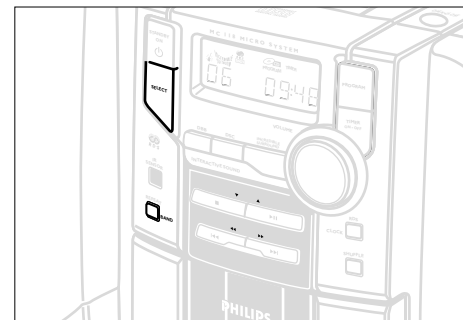

- To clean the CD, wipe in a straight line from the centre towards the edge using a soft, lint-free cloth. Do not use cleaning agents as they may damage the disc.
- Never write on a CD or attach any stickers to it.

DIGITAL TUNER



English

Tuning to radio stations

- Select **TUNER** source.
→ **TUNER** is displayed briefly.
 - Press **REPEAT/BAND** once or more to select your waveband.
 - Press down on **TUNING**  or  and release button.
→ The radio automatically tunes to a station with sufficient reception. Display indication during automatic tuning: **SEARCH**.
→ If a FM station is received in stereo, **STEREO** is shown.
 - Repeat step 3 if necessary until you find the desired station.
- To tune to a weak station, press **TUNING**  or  briefly and repeatedly until you have found optimal reception.

Programming radio stations

You can store up to a total of 40 radio stations in the memory.

Automatic programming

Automatic programming will start with a chosen preset number. From this preset number upwards, former programmed radio stations will be overwritten. The unit will only programme stations which are not in the memory already.

- 1 Press PRESET ▼ or ▲ (◀ or ▶) on the remote control) to select the preset number where programming should start.

Note: If no preset number is selected, default is preset 1 and all your presets will be overwritten.

- 2 Press PROGRAM on the set or remote control for more than 2 seconds to activate programming.
 - AUTO is displayed and available stations are programmed in order of waveband reception strength: FM followed by MW and then LW stations. The last preset automatically stored will then be played.

Manual programming

- 1 Tune to your desired station (see Tuning to radio stations).
- 2 Press PROGRAM on the set or remote control to activate programming.
 - PROGRAM flashes in the display.
- 3 Press PRESET ▼ or ▲ (◀ or ▶) on the remote control) to allocate a number from 1 to 40 to this station.

- 4 Press PROGRAM again to confirm the setting.
 - PROGRAM disappears, the preset number and the frequency of the preset station are shown.

- 5 Repeat the above four steps to store other stations.

- You can overwrite a preset station by storing another frequency in its place.

Tuning to preset stations

Press PRESET ▼ or ▲ (◀ or ▶) on the remote control) until the desired preset station is displayed.

Changing tuning grid (some versions only)

In North and South America the frequency step between adjacent channels in the AM and FM band are **10 KHz** and **100 KHz** respectively. In the rest of the world this step is **9 KHz** and **50 KHz**. Usually the frequency step has been preset in the factory for your area if not:

- 1 Select TUNER source.
- 2 Press SHUFFLE on the set for at least 5 seconds.
 - The display shows either **GRID 9** or **GRID 10**.

Note: All preset stations will be lost and need to be reprogrammed.

Switching FM antenna sensitivity

If the signal of the FM station is too strong or too weak it is possible to adjust the antenna sensitivity.

- Press REPEAT/BAND on the set until the display shows LOCAL or DISTANT.

RDS

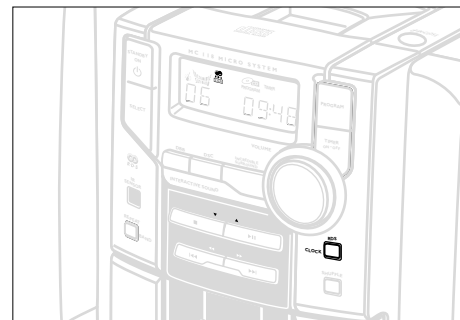

RDS (some versions only)

Radio Data System is a service that allows FM stations to show additional information. If you are receiving a RDS station, **R-D-S** and the station name are displayed. When automatic programming is used, RDS stations will be programmed first.

Scrolling through different RDS information

- Press RDS/ CLOCK briefly and repeatedly to scroll through the following information (if available):
 - Station name
 - Programme type such as NEWS, SPORT, POP M...
 - Radio text messages
 - Frequency

Note: If you press RDS/ CLOCK and the RDS signal is not available NO RDS is displayed.

EON

Enhanced Other Network allows you to search for an RDS station offering a certain programme type. If EON is available, **EON** is shown.

CASSETTE RECORDER

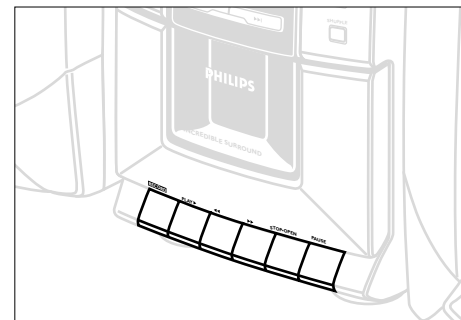

Cassette playback

- 1 Select TAPE source.
→ The display shows TAPE throughout tape operation.
 - 2 Press STOP•OPEN to open the cassette door.
 - 3 Insert a recorded cassette and close the cassette door.
 - 4 Press PLAY ► to start playback.
 - 5 To interrupt playback press PAUSE. To resume, press this key again.
 - 6 By pressing ◀◀ or ▶▶ on the set fast winding of the tape is possible in both directions.
 - 7 To stop the tape, press STOP•OPEN.
- The keys are automatically released at the end of the tape, except if PAUSE has been activated.

Note: The sound source cannot be changed while playing or recording a cassette.

Searching programme type (PTY)

PTY helps you find a desired programme type. To enable PTY, first programme RDS stations into the tuner memory (see Programming radio stations)

- 1 While receiving an RDS station, press RDS/ CLOCK briefly until the programme type is displayed.
- 2 Press PRESET ▼ or ▲ (◀ or ▶ on the remote control) until the desired programme type is displayed.
- 3 Press and hold down on TUNING ◀◀ or ▶▶ (◀◀ or ▶▶ on the remote control) to start searching.
 - The radio tunes to a RDS station broadcasting this programme type. If the programme type is not available TYPE NOT FOUND is displayed.

• RDS Programme types

NO TYPE	No RDS programme type
NEWS	News services
AFFAIRS	Politics and current affairs
INFO	Special information programmes
SPORT	Sports
EDUCATE	Education and advanced training
DRAMA	Radio plays and literature
CULTURE	Culture, religion and society
SCIENCE	Science
VARIETY	Entertainment programmes
POP M.	Pop music
ROCK M.	Rock music
MOR M.	Light music
LIGHT M.	Light classical music
CLASSICS	Classical music
OTHER M.	Special music programmes

RDS News and Traffic Announcement (TA)

You may set up the tuner in such a way that listening to CD or tape is interrupted by the news of a RDS station. This only works if the RDS station broadcasts a NEWS signal while sending the news.

- 1 Tune to the desired RDS station.
- 2 Press NEWS/TA once or more on the remote control to select the news option.
→ NEWS ON, TA ON or OFF is displayed briefly.
→ NEWS is displayed if you have activated the news or TA option. Changing listening source will not disarm the function.

Notes:

- To avoid unwanted recordings, the NEWS announcement does not work while recording a cassette.
- When you receive RDS news or traffic announcements during CD playback, playback will pause and you will be able to hear the news/TA. Playback resumes after the broadcast has finished. In tape mode, the tape continues playing but you will hear the news/TA only until the broadcast has finished.
- If you are using the RDS NEWS announcement with an EON station, the whole network is searched for the respective news.

Disarming RDS News and Traffic Announcement

There are a number of ways to disarm the news feature:

- Press NEWS/TA on the remote control during reception of the news option.
- Press standby on the set or remote control.
- Tune to a non-RDS-station.

GENERAL INFORMATION ON RECORDING

- Recording is permissible insofar as copyright or other rights of third parties are not infringed.
- This deck is not suited for recording on CHROME (IEC II) or METAL (IEC IV) type cassettes. For recording, use only NORMAL type cassettes (IEC type I) on which the tabs have not yet been broken.
- The best recording level is set automatically. Altering the VOLUME, INCREDIBLE SURROUND, DBB or INTERACTIVE SOUND controls will not affect the recording in progress.
- At the very beginning and end of the tape, no recording will take place during the 7 seconds when the leader tape passes the recorder heads.
- To protect a tape from accidental erasure, have the tape in front of you and break out the left tab. Recording on this side is no longer possible. If, however, you wish to record over this side again, cover the tabs with a piece of adhesive tape.

Synchro Start CD recording

- Select CD source.
- Insert a CD and if desired, programme track numbers.
- Press STOP•OPEN to open the cassette door.
- Insert a suitable tape into the cassette deck and close the cassette door.
- Press RECORD to start recording.
 - Playing of the CD programme starts automatically from the beginning of the CD/programme after 7 seconds. It is not necessary to start the CD player separately.

To select and record a particular passage within a track:

- Press and hold down on PREV ◀◀ or NEXT ▶▶ (on the remote control ◀◀ or ▶▶).
 - When you recognize the passage you want, release PREV ◀◀ or NEXT ▶▶.
 - To interrupt CD playback press PLAY•PAUSE ▶▶ (on the remote control SIDE/ II).
 - Recording will begin from this exact point in the track when you press RECORD.
- For brief interruptions during recording, press PAUSE. To resume recording, press PAUSE again.
 - To stop recording, press STOP•OPEN.

Recording from the Radio

- Tune to the desired radio station (see Tuning to radio stations).
- Press STOP•OPEN to open the cassette door.
- Insert a suitable tape into the cassette deck and close the cassette door.
- Press RECORD to start recording.
- For brief interruptions, press PAUSE. To resume recording, press PAUSE again.
- To stop recording, press STOP•OPEN.

Recording from AUX

- Select AUX source.
- If necessary, prepare the additional appliance for recording.
- Press RECORD to start recording.

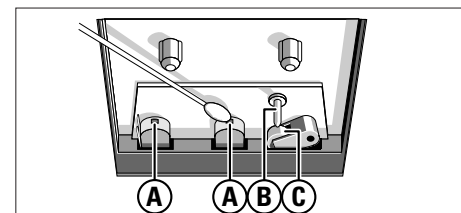

Tape deck maintenance

To ensure quality recording and playback of the tape deck, clean parts (A), (B) and (C) shown in the diagram below, after approx. 50 hours of operation, or on average once a month. Use a cotton bud slightly moistened with alcohol or a special head cleaning fluid to clean the deck.

- Open the cassette door by pressing STOP•OPEN.
- Press PLAY ▶ and clean the rubber pressure roller (C).
- Press PAUSE and clean the magnetic heads (A), and also the capstan (B).
- After cleaning, press STOP•OPEN.

Note: Cleaning of the heads can also be done by playing a cleaning cassette through once.

TROUBLESHOOTING

WARNING

Do not open the set as there is a risk of electric shock! Under no circumstances should you try to repair the set yourself, as this will invalidate the guarantee.

If a fault occurs, first check the points listed below before taking the set for repair.

If you are unable to remedy a problem by following these hints, consult your dealer or service centre.

Problem	Possible cause	Remedy
No sound /power	Volume not adjusted	Adjust the VOLUME
	Headphones connected	Disconnect headphones
	Mains lead not securely plugged to wall socket	Plug in properly
Reversed left and right sound/ no sound from one speaker	Speakers incorrectly connected	Connect properly: L to left, R to right
TIMER/SLEEPER does not work	Clock time not set	Set the correct clock time
Severe radio hum or noise	Electrical interference: set too close to TV, VCR or computer	Increase the distance
Poor radio reception	Weak radio signal	FM: Direct the FM aerial wire for optimum reception
NO DISC indication	CD badly scratched or dirty	Replace/ clean CD, see Maintenance
	CD-R(W) is blank or the disc is not finalised	Use a finalised CD-R(W)
	Laser lens steamed up	Wait until lens has cleared
The CD skips tracks	CD damaged or dirty	Replace or clean CD
	SHUFFLE or PROGRAM is active	Switch off SHUFFLE / PROGRAM
Poor cassette sound quality	Dust and dirt on the heads, etc.	Clean deck parts, see Maintenance
	Use of incompatible cassette types (METAL or CHROME)	Only use NORMAL (IEC I) for recording
Recording does not work	Cassette tab(s) may be broken	Apply a piece of adhesive tape over the missing tab space.
Remote control does not function properly	Batteries exhausted	Insert fresh batteries
	Batteries incorrectly inserted	Insert the batteries correctly
	Distance/ angle between the set too large	Reduce the distance/ angle.

TECHNICAL DATA

Amplifier

Output power	2 x 5 W RMS
Output power	150 W PMPO
Signal-to-noise-ratio	≥ 65 dBA (IEC)
Input sensitivity AUX	0.5 V (max. 2 V)
Impedance loudspeakers	8 Ω
Impedance headphones	32 Ω -1000 Ω

Tuner

FM wave range	87.5 - 108 MHz
MW wave range	531 - 1602 kHz
LW wave range	153 - 279 kHz
Sensitivity at 75 Ω	
– mono, 26 dB signal-to-noise ratio	2.8 μV
– stereo, 46 dB signal-to-noise ratio	61.4 μV
Selectivity	≥ 28 dB
Total harmonic distortion	≤ 5%
Frequency response	63 - 12500 Hz (± 3 dB)
Signal-to-noise-ratio	≥ 50 dBA

CD player

Frequency range	20 - 20000 Hz
Signal-to-noise-ratio	75 dBA

Tape deck

Frequency response	
– Normal tape (type I)	120 - 10000 Hz (8 dB)
Signal-to-noise-ratio (without Dolby NR)	
– Normal tape (type I)	48 dBA
Wow and flutter	≤ 0.4% DIN

Speakers

Bass reflex system	
Dimensions (wxhxd)	155 x 220 x 220

General

Dimensions (wxhxd)	140 x 223 x 253
Weight (with / without speakers)	approx 6.0 / 2.8 kg
Standby power consumption	< 2 W

Subject to modification