

# ***Philips Multimedia projector LC5141, LC5131***

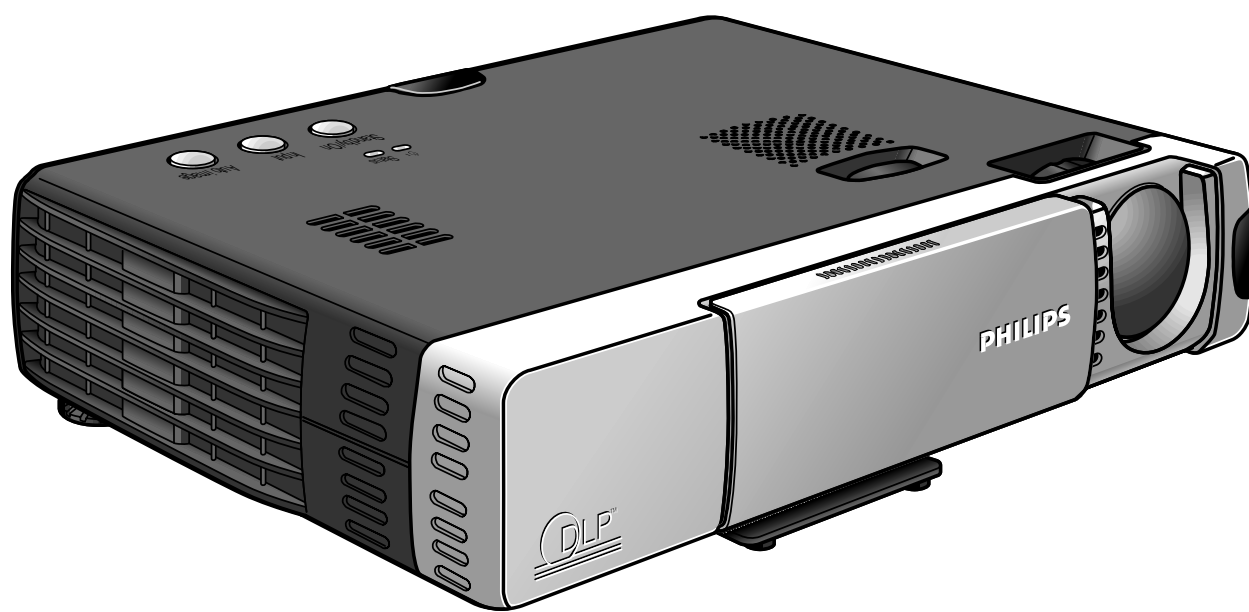

## ***User guide English***

**UGO**  

---

Series

# 0. Controls and connections

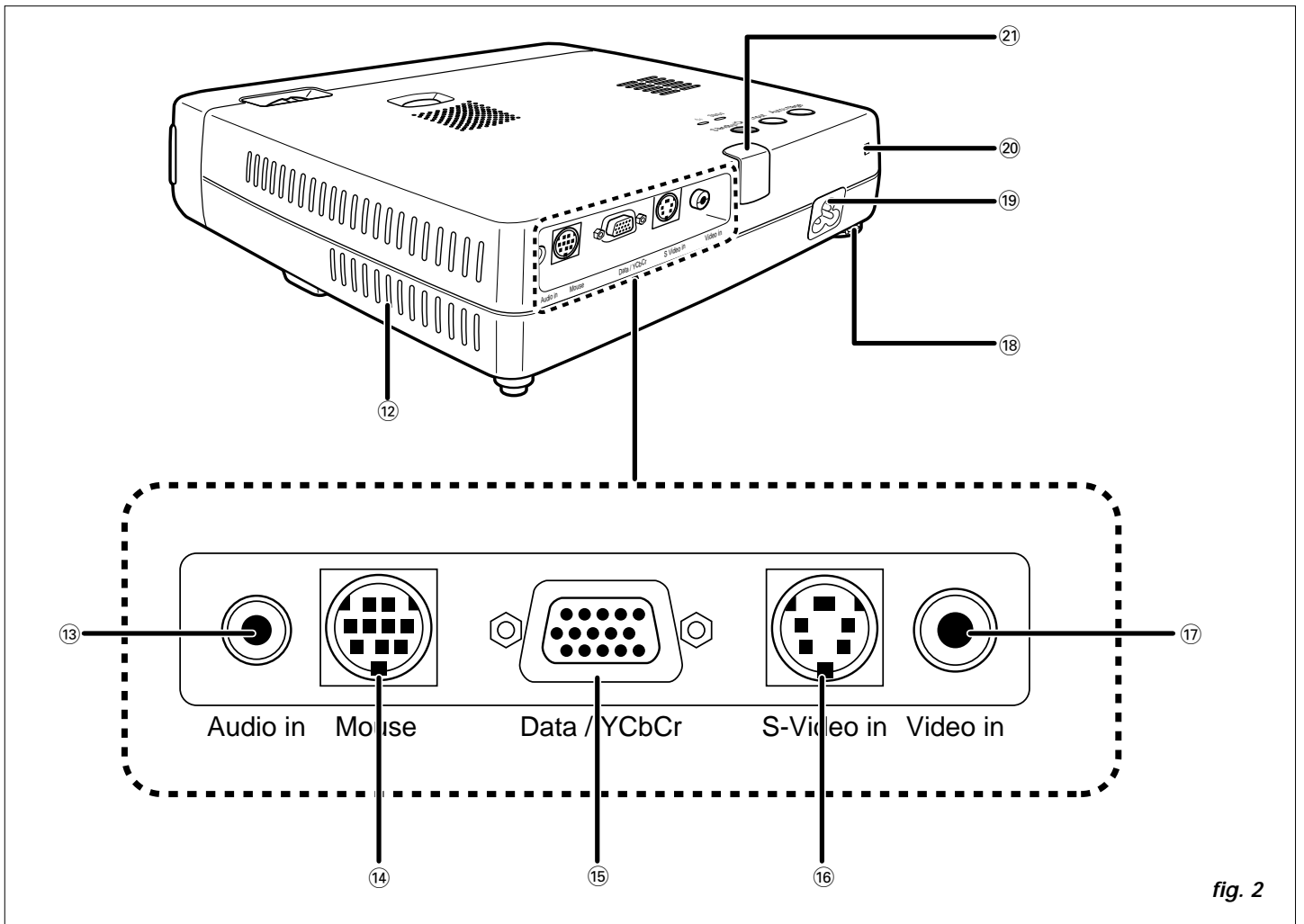
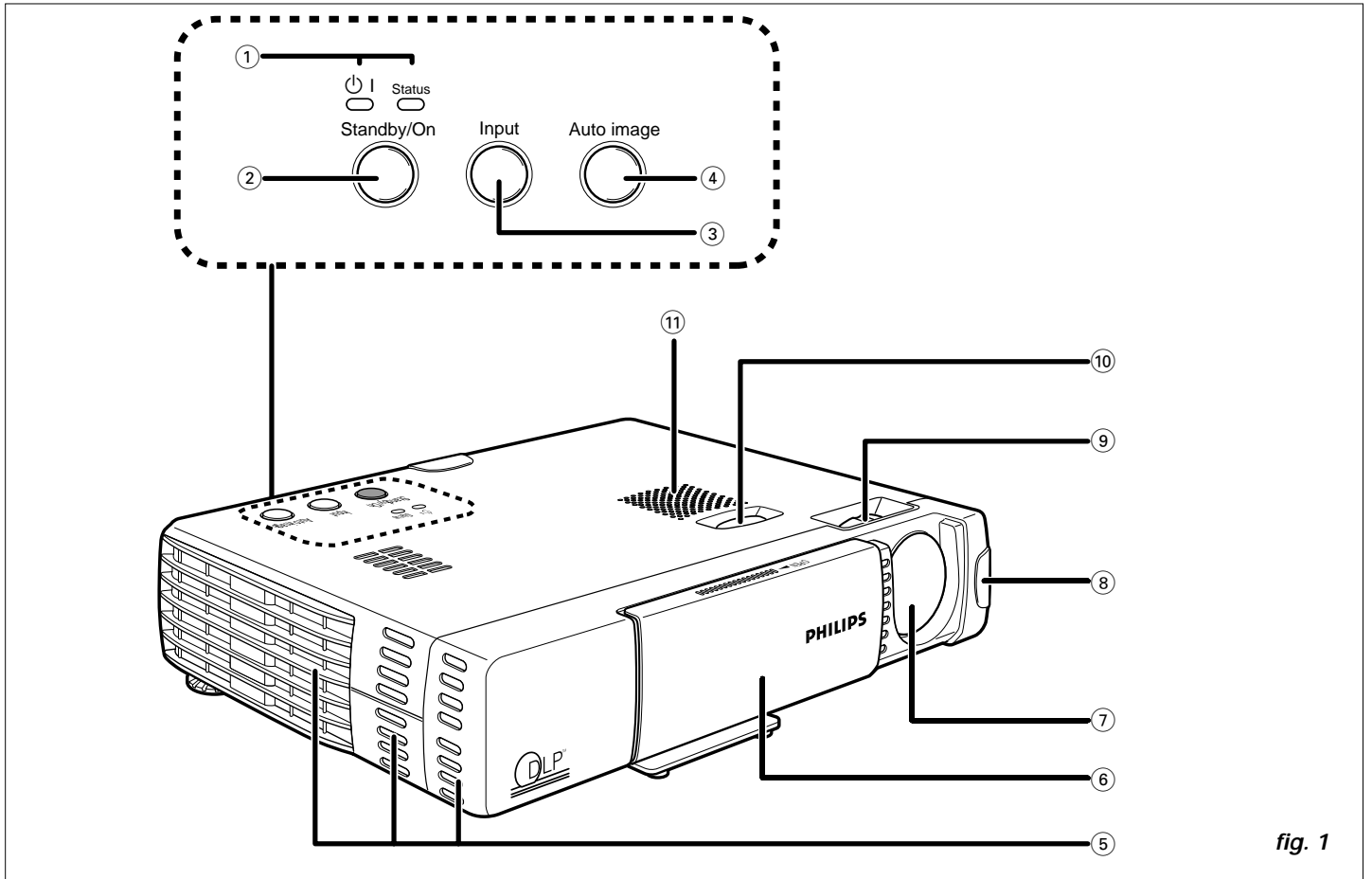

# 0. Controls and connections

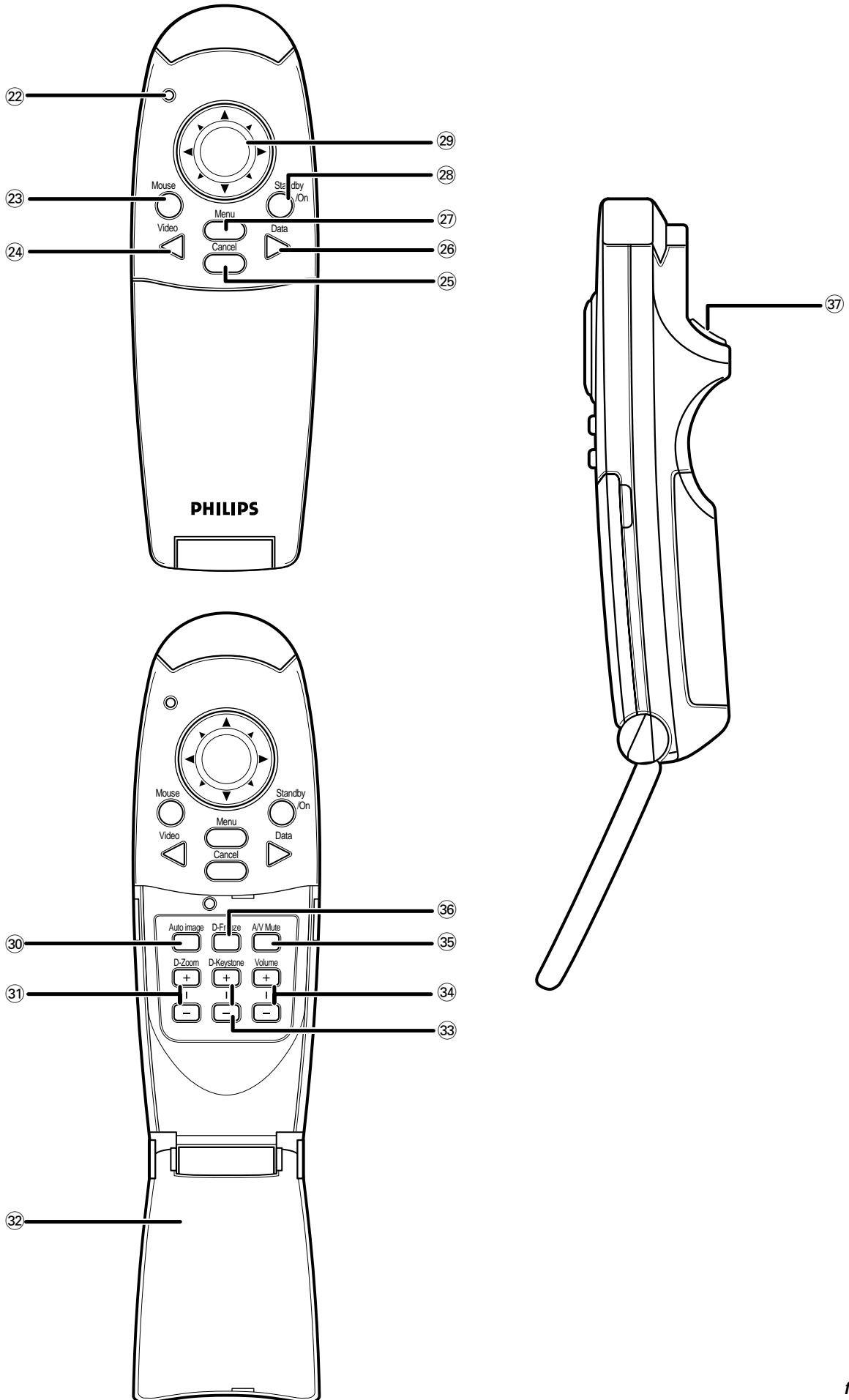

fig. 3

# 1. Introduction

# 2. Things You Should Know

## Table of contents

<b>0. Controls and connections</b> .....	<b>2</b>
<b>1. Introduction</b> .....	<b>4</b>
Table of contents .....	4
Introduction .....	4
Packaging contents .....	4
<b>2. Things You Should Know</b> .....	<b>4</b>
<b>3. Important Safeguards</b> .....	<b>5</b>
<b>4. Projector Features</b> .....	<b>6</b>
<b>5. Functional Overview</b> .....	<b>7</b>
Projector .....	7
Remote control .....	7
<b>6. Set Up</b> .....	<b>8-10</b>
Positioning the projector and screen.....	8
Mains supply .....	8
Adjusting the focus of the image.....	9
Adjusting height and level of the projector .....	9
Moving the projector .....	9
Inserting the batteries in the remote control .....	10
Using the remote control as PC mouse .....	10
<b>7. Installation</b> .....	<b>11-14</b>
Video/computer cables and adapter .....	11
Connecting to a computer .....	12
Connecting to PC mouse connector .....	12
Connecting to video equipment .....	13
<b>8. Operation</b> .....	<b>15-21</b>
Preparation .....	15
Menu structure - data input.....	16
Menu structure - video input.....	17
Display and picture control / Audio volume control.....	18
Other settings.....	20
<b>9. Maintenance</b> .....	<b>22-23</b>
Cleaning .....	22
Lamp.....	22
Lamp replacement.....	22
Resetting the lamplife time .....	23
<b>10. Troubleshooting</b> .....	<b>24</b>

## Introduction

Congratulations on your purchase of one of the most spectacular multimedia projectors on the market today. We are sure that, used properly, it will bring you years of enjoyment. You will want to keep this manual handy, as it is a convenient source of information about your projector. For your own protection and prolonged operation of your projector, please read the 'Important Safeguards' section before use.

## Packaging contents

Please confirm that the following items are packed in the accessories box. They are provided to help you use or set up your projector.

- UGO X-lite or S-lite (resp. XGA or SVGA) projector
- Remote control + 2 x AAA 1,5V/LR03 batteries
- Power cord (USA version + Continental Europe version)
- VGA Cable
- Mouse cable set (PS/2 + USB)
- RCA Video cable
- PC Audio cable
- S-Video cable
- Audio conversion cable
- Soft carrying bag + Cable bag
- User guide (CD-ROM + Quick Reference Guide)

**Note:** This equipment has been tested to comply with the limits for a class A digital device in accordance with Part 15 of the FCC Rules as well as the European CE marking and Canadian ICES-003.

Operation is subject to the following two conditions:

1. This device may not cause harmful interference, and
2. This device must accept any interference received, including interference that may cause undesired operation.

These limits are designed to provide reasonable protection against harmful interference when the equipment is operated in a commercial environment.

This equipment generates, uses, and can radiate radio frequency energy and, if not installed and used in accordance with the user's guide, may cause harmful interference to radio communications.

Operation of this equipment in a residential area is likely to cause harmful interference in which case the user will be required to correct the interference at his own expense.

If this equipment does cause harmful interference to radio or television reception, which can be determined by turning the equipment off and on, the user is encouraged to try to correct the interference by one or more of the following measures:

- Reorientate or relocate the receiving antenna.
- Increase the distance between the equipment and receiver.
- Connect the equipment into an outlet on a circuit different from that to which the receiver is connected.
- Consult the dealer or an experienced radio/TV technician for help.

### FCC Warning:

To assure continued compliance, use only the provided grounded power supply cord and shielded interface cables when connecting this device to a computer. Also, any unauthorized changes or modifications to this equipment could void the user's authority to operate this device.

**Note:** Save energy! Please put the projector in the STANDBY position if you are not going to use the projector for more than 15 minutes.

## Important note for users in the U.S.A.

The responsible party of this multimedia projector is the following:

Philips Consumer Electronics Company  
One Philips Drive  
Knoxville, TN 37914  
Telephone (1888) 873-4672

### IMPORTANT

Digital Light Processing, DLP, Digital Micromirror Device and DMD are all trademarks of Texas Instruments Inc.

Windows 98, Windows 95, and Windows 3.1 are registered trademarks in the United States and other countries of Microsoft Corporation. IBM is a registered trademark of International Business Machines Corporation. Macintosh and MAC are trademarks of Apple Computer Inc. Other names of companies and products mentioned are trademarks and registered trademarks of the respective companies. TM, ® and © marks are not used in this document.

### 3. Important Safeguards



**CAUTION:** Please read all of these instructions before you operate your projector.

Save these instructions for future reference.

*Electrical energy can perform many useful functions.*

*This projector has been engineered and manufactured to meet applicable safety standards. IMPROPER USE CAN RESULT IN POTENTIAL ELECTRICAL SHOCK OR FIRE HAZARDS. In order not to defeat the safeguards incorporated into this projector, observe the following basic rules for its installation, use and servicing.*

1. Unplug the projector from the wall outlet before cleaning or lamp replacement.
2. Do not use liquid cleaners or aerosol cleaners. Use a soft dry cloth to clean the projector unit. If the unit is very dirty, wet a cloth with neutral detergent, squeeze it tight, wipe the unit with it, and finish by wiping with a dry cloth. Do not use a chemical duster or polisher-cleaner because it can adversely affect the unit and peel the paint.
3. Do not use attachments not recommended by PHILIPS, as they may cause hazards.
4. Do not use the projector near water- for example, near a bathtub, washbowl, kitchen sink, or laundry tub, in a wet basement, near a swimming pool, etc. Never spill liquid into the projector.
5. Do not place the projector on an unstable cart, stand, or table. The projector may fall, which may cause serious injury to a child or an adult and/or serious damage to the unit. Use only with a cart or stand recommended by its manufacturer as being suitable for use with a projector.
6. Ceiling, wall or shelf mounting should be done with a mounting kit approved by the manufacturer for use with a projector and should follow the manufacturer's instructions.
7. Projector equipment and cart combinations should be moved with care. Quick stops, excessive force, and uneven surfaces may cause the equipment and cart combination to overturn.
8. Slots and openings in the cabinet are provided for ventilation. To ensure reliable operation of the projector and to protect it from overheating, these openings must not be blocked or covered. These openings should never be covered with cloth or other material. The bottom opening should not be blocked by placing the projector on a bed, sofa, rug, or other similar surface. The projector should not be placed near or over a radiator or heating vent. The projector should not be placed in a built-in installation such as a bookcase unless proper ventilation is provided.
9. The projector should be operated only from the type of power source indicated on the bottom of the projector or in the specifications and with the appropriate power cord. If you are not sure of the type of power supplied to your business or the right type of power cord, consult your projector dealer or local power company.
10. Do not allow anything to rest on the power cord. Do not place the projector where the cord will be walked on.
11. Follow all warnings and instructions marked on the projector.
12. As a safety feature, this projector is equipped with power cord with a 3-pin grounded plug (for USA-versions only) or a 2-pin grounded plug (for European versions only). The 3-pin/2-pin grounded plug will fit only into a grounding type power outlet. If the plug does not fit, use an adapter that is properly grounded or have an electrician install a grounded type outlet. Do not attempt to modify this AC plug.
13. For added protection of the projector during a lightning storm, or when it is left unattended or not in use for long periods of time, unplug it from the wall outlet and disconnect any cable systems. This will prevent damage to the projector due to lightning and power-line surges.
14. Do not overload wall outlets and extension cords with too many products, because this can cause a fire or electric shock.
15. Never push objects of any kind into the projector through cabinet slots as they may touch dangerous voltage points or short cut parts, which could result in a fire or electric shock.
16. Do not attempt to service the projector yourself other than maintenance issues presented in chapter 'Maintenance'. Opening or removing covers may expose you to dangerous voltage or other hazards. Refer all servicing to qualified service personnel.
17. Unplug the projector from the wall outlet and refer servicing to qualified service personnel under the following conditions:
  - A. When the power cord or plug is damaged or frayed.
  - B. If liquid has been spilled into the projector.
  - C. If the projector has been exposed to rain or water.
  - D. If the projector does not operate normally when you follow the operating instructions. Adjust only those controls that are covered by the operating instructions; improper adjustment of other controls may cause damage and will often require extensive work by a qualified technician to restore the projector to normal operation.
  - E. If the projector has been dropped or the cabinet has been damaged.
  - F. When the projector exhibits a distinct change in performance – (this indicates a need for service).
18. Upon completion of any service or repairs to the projector, ask the service technician to perform a routine safety check to check that the projector is in safe operating condition.
19. When replacement parts are required, be sure the service technician has used replacement parts specified by the manufacturer that have the same characteristics as the original parts. Unauthorized substitutions may result in fire, electric shock, or other hazards.
20. Clean the ventilation slots and speaker grills on the unit periodically using a vacuum cleaner. If accumulated dust blocks the ventilation slots, the unit will overheat, which may cause the unit to malfunction. Use a soft brush attachment when using the vacuum cleaner. Do not use a hard attachment, such as a crevice tool, to prevent the damage to the unit.
21. If the lens becomes dirty or smudged, clean it with a clean, dampened cloth. Never touch the lens with your fingers.
22. Do not look directly into the aperture and lens while operating the projector as this may damage your eyes.

## 4. Projector Features

### 1. UGO X-lite; LC5141

Fully compatible with true XGA; support for SXGA using advanced intelligent compression technology. The advanced intelligent compression technology enables these projectors to present clear compression SXGA images without any line omission.

### UGO S-lite; LC5131

Fully compatible with true S-VGA; support for XGA using advanced intelligent compression technology. The advanced intelligent compression technology enables it to present clear compression XGA images without any line omission.

### 2. Ultra compact design

Superior brightness of 800 ANSI lumens, small size, and weighing only about 1.3 kilograms/2.9 lbs. Using TI's Digital Mirror Device (DMD™) and a keen optical design a geometric effect is developed that increases the light usage efficiency. By increasing the light usage efficiency we can better reproduce the three basic colors (RGB) required for color reproduction on a single DMD. This means superior brightness, smaller size, and lighter weight.

### 3. Superb picture performance

Sharp, clear images. There is no RGB color separation, and the spaces between the individual pixels are not noticeable. That means sharp and clear reproduction of small characters and figures. Take a closer look and notice the difference in quality!

Outstanding sharp, clear, 3D like images with vivid colors when reproducing DVD video and other high picture quality data/video sources. Faithful gray scale reproduction makes for more natural image displays. DVD and other high quality image sources bring out the true display capacity of the unit.

### 4. Fully compatible with PC and MAC

The projector will adapt automatically to the proper data source. The 'auto image' feature automatically sizes and positions the image to fit optimally in the screen picture.

### 5. High reliability and excellent brightness

The new UHP lamp guarantees long life, excellent brightness over the lamp's lifetime and excellent colour reproduction. Furthermore, the projector has an excellent uniformity of brightness over the whole screen.

### 6. Excellent video quality

The projector accepts the input signal of all major video formats, including PAL, SECAM, NTSC and the higher quality S-Video and component (YCbCr) Video signals. The projector will recognize these standards and adapt to them automatically.

### 7. Very easy to install and operate

The **OSD** (On Screen Display) information screens and menus in 8 languages provide you with additional information to help you make the right choices about installation and operation, and to perform the correct actions. The standard OSD language is English. In addition you can select French, Spanish, German, Italian, Swedish, Chinese and Japanese.

The transmitter of the wireless remote control allows you to operate both your computer as well as your projector from almost anywhere in the room. The **directional shuttle** on the **remote control** function as **Cursor Control** and is used to manipulate the mouse cursor on the connected computer, as long as the menu is not active.

The local keyboard and remote control provide direct access buttons for those functions that are most often used during presentations:

#### **Input / source selection buttons**

With the VIDEO and DATA buttons you can directly select the required source: S-video, Video or Data.

#### **Standby/On**

Switches the projector in the Standby/On mode.

### 8. Full mirror scan conversion

The projector is equipped with a full mirror scan conversion function ('vertical/horizontal mirror').

### 9. Digital features

The digital features of the projector are of great value for an attractive presentation.

**Digital keystone correction:** A keystone image (picture top width larger than picture bottom width or vice versa) appears when the relative positions of the projector and the screen are not correct. With the 'vertical keystone correction' feature you can correct this picture distortion. Vertical keystone correction is accessible in the 'Display' submenu of the OSD menu.

**Digital zoom:** With 'digital zoom' a specific part of the projected image can be enlarged. By means of the cursor control you can pan over the screen to the desired part of the presented image.

**Digital freeze:** The 'digital freeze' feature enables you to capture moving pictures (still picture).

**Note:** *The screen is not distorted to a trapezoid (keystoning) when projecting to the height of the line of vision. Because the projection position is already set to the height of the line of vision, there is no keystone effect. Even when projecting above or under the height of the line of vision, image distortion (if any) can be adjusted using the key-stone correction function.*

### 10. Handy and ergonomical Remote Control Unit

A remote control that can operate the PC or Macintosh. The supplied remote control both operates the unit and acts as a wireless mouse control to operate the PC or Macintosh connected to the unit.

## Projector

### front (fig. 1)

- ① **Indicators**  
Standby / On (⏻) indicator
  - Lights up orange in Standby mode
  - Flashes green when the lamp is starting up (1 min.)
  - Lights up green when the lamp is on
  - Flashes orange when the projector is switched from the on into the standby mode (1 min)
 Status indicator (see also page 24)
  - Off: projector is in normal mode
  - On: lamp life of the projection lamp nears or the end or is expired.
- ② **Standby/On**  
For switching the projector in the power standby mode.
- ③ **Input selection button**  
To toggle between Video, S-Video and Data signal.
- ④ **Auto image button**
- ⑤ **Ventilation slots**
- ⑥ **Sliding lens cap**
- ⑦ **Lens**
- ⑧ **IR sensor**  
Receives the signals from the remote control.
- ⑨ **Focus ring**  
To adjust the focus of the projected image.
- ⑩ **Height adjuster button**  
To adjust the projection angle of the projector.
- ⑪ **Built-in speaker**

## Remote control

### (fig. 3)

- ⑫ **LED**  
The red LED lights during infrared transmission.
- ⑬ **Mouse**  
To activate the mouse control function by means of the cursor key as mouse control navigator, OK button as the L-click mouse button and the Cancel button as the R-click mouse button. (Lights up red when in function).
- ⑭ **Video**  
To select the video signal as the current projection source.
- ⑮ **Cancel (R-click mouse)**  
To cancel the selected menu function.
- ⑯ **Data**  
To selecting the DATA signal as the current projection source.
- ⑰ **Menu**  
To activate and de-activate the menu.
- ⑱ **Standby/On**  
For switching the projector in the power standby mode.
- ⑲ **Cursor Control**  
To manipulate the mouse cursor on the connected computer as long as the menu is not active. When the menu is active the Cursor Control controls the menu cursor.

### rear (fig. 2)

- ⑫ **Ventilation slots**
- ⑬ **Audio in**  
Input sockets for connection to the Audio OUT sockets of a video recorder (S-VHS, PAL, NTSC, SECAM) or to the Audio OUT socket of a PC.
- ⑭ **Mouse**  
Socket for connecting a computer mouse.
- ⑮ **Data / YCbCr**  
Input socket for connecting to the Data out terminal of a computer or the component video signal output.
- ⑯ **S-Video in**  
Input socket for connecting to the S-VIDEO OUT socket of a S-VHS video recorder, a VCR, Laser Disc player, video camera or TV.
- ⑰ **Video in**  
Input socket for connecting to the VIDEO OUT socket of a video recorder, Laser Disc player, video camera or TV with AV output socket (PAL, NTSC, SECAM).
- ⑱ **Skew adjuster**  
To adjust the skew of the horizontal line of the projected image.
- ⑲ **Power socket**  
To connect the projector to the mains.
- ⑳ **Lock slit**  
To insert an optional locking device (Kensington lock).
- ㉑ **IR sensor**  
Receives the signals from the remote control.

### flip cover open

- ⑳ **Auto image**  
To automatically size and position the image to fit optimally in the screen picture in accordance with the resolution. Functions only in Data mode.
- ㉑ **D-Zoom +/- (Digital Zoom)**  
To enlarge the picture to a maximum of ten times the original size.
- ㉒ **Flip cover**
- ㉓ **D-Keystone +/- (Digital Keystone)**  
To correct picture distortion of the vertical keystone type.
- ㉔ **Volume +/-**  
To adjust the audio volume via the built-in speaker.
- ㉕ **AV Mute**  
To turn off the image and mute the sound at the same time. To restore the picture and sound, press the button again.
- ㉖ **D-Freeze (Digital Freeze)**  
To display a still image of the current frame. To restore the present picture, press the button again.
- ㉗ **OK (L-click mouse)**  
To confirm action in the menu when the menu is on screen.

## 6. Set Up

The distance from the projector lens to the screen determines to the size of the projected image, therefore, you need to consider the place where you set up the projector and screen before making connections. You also need to consider the screen size and height of the projector and screen as other important factors.

**Tip:** A non-glossy wall may be used as a substitute for a screen.

### Warning

- Always carry the projector in the carrying bag. Ensure that the power cable and any other cables connecting to Audio/Video sources are disconnected before moving the projector. When moving the projector or when it is not in use, cover the lens with the sliding lens cap.
- Only use the projector on a solid flat level surface. If the projector falls to the ground, you may be injured and the projector may severely be damaged.
- Do not use the projector where temperatures vary greatly. The projector must be used at temperatures between 5°C (41°F) and 35°C (95°F).
- Do not expose the projector to moisture, dust, or smoke. This may harm the screen image.
- Ensure that you have adequate ventilation around the projector to allow heat dissipation. Do not cover the ventilation slots on the bottom or the side of the projector.

### Positioning the projector and screen

- Place the projector on a stable, level surface, out of direct sunlight and away from sources of excessive dust, dirt, heat, water, moisture, vibration and strong magnetic fields. Face the projector towards the screen for the best picture results. To determine the distance for the desired size, please refer to the Projection Assistant, a calculation programme included on the CD-ROM.

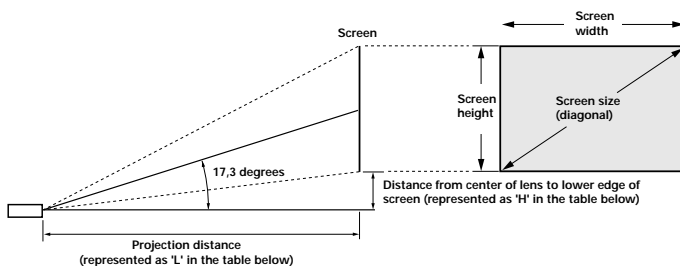

- The projected image becomes larger as the distance between the projector and screen increases. The minimum image size is about 36 inches diagonally at a distance of about 1.2 m (approx. 3.9 feet) and the maximum size is approx. 200 inches at a distance of 6.8 m (approx. 22.3 feet) from the screen. Use the following information when you fix the position of the projector.

Screen size diagonal		Projection distance (L)		Distance lens from center lens to bottom of image (H)	
mtrs	inch	mtrs	feet	cm	inch
0,94	36	1,2	3,93	9,1	3,9
1,52	60	2,0	6,56	16,9	6,65
2,03	80	2,7	8,85	22,5	8,86
2,54	100	3,4	11,15	28,1	11,06
3,05	120	4,1	13,45	33,7	13,27
3,81	150	5,1	16,73	42,2	16,61
6,08	200	6,8	22,30	56,2	22,13

- The screen should be positioned so that it is not directly touched by sunlight or artificial light, as this will wash out the colours of the picture, making it hard to see.
- The projector can be used for both front projection and rear projection applications. As default factory setting, the projector has been set up for front projection. You can change to rear projection via the OSD menu.
- Choose a screen size suitable for the number of viewers and the size of the room.
- Picture quality is best when you sit directly in front of the projector screen.

### Mains supply

1. Insert the power cord into the projector's Power socket and connect it to the wall socket.
  - The Standby / On (Ⓞ I) indicator will light orange, the exhaust fan will operate at slow speed and the standby status will be activated.

**Note:** The standby indicator lights up orange, the projector is now in the Standby/On mode.

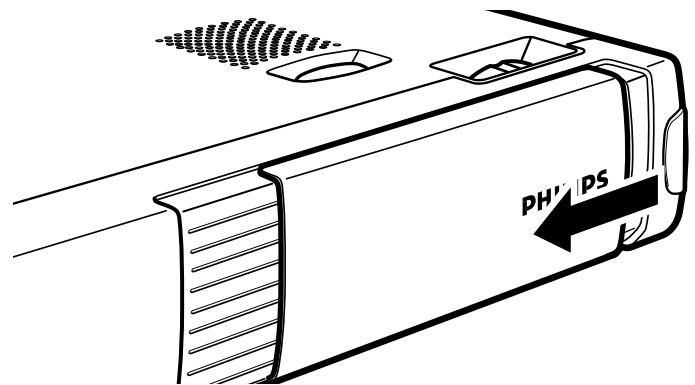

2. Slide the lens cap open.
3. Press the Standby/On button to switch on the projector.
  - The Standby/On indicator flashes green and the start-up screen appears for approximately 5 seconds.
  - It takes one minute for the projector to be ready for use. Wait until the indicator stops flashing and lights steadily in green.





## 6. Set Up

- To switch off the mains supply completely, pull the mains plug out of the wall socket.

**Note:** Before disconnecting the power cord, make sure that the cooling fan has stopped (about 3 minutes after the projector has been switched to Standby).

### Adjusting the focus of the image

- Use the Focus ring to adjust the focus of the image.

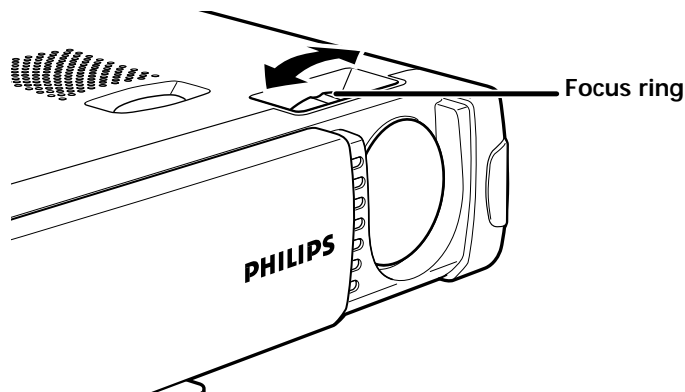

### Adjusting height and level of the projector

- Use the Height/Level Adjuster to adjust the vertical angle of the projector as specified under 'Positioning the projector and screen'.

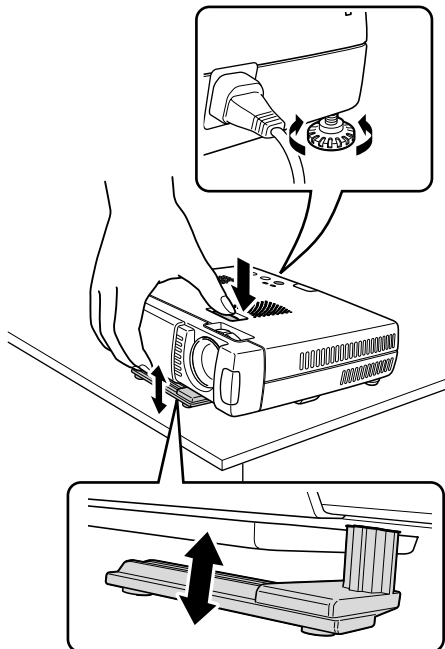

### Projection angle

- Press the adjuster button on the top cover of the projector.
- Lift the projector to allow the adjuster leg to drop into position.
- Release the button. The extended adjuster legs will be locked.

### Skew correction

- Turn the rear adjuster either clock-wise or counterclockwise to accurately adjust the skew.
- Use the Focus ring to readjust the focus of the image.

### Vertical keystone correction

If projector and screen are not properly placed, the picture will be distorted, producing a keystone image. Vertical keystone correction allows you to correct picture distortion of the vertical keystone type by internal scaling. By pressing the D-Keystone +/- buttons of the remote control you can fine adjust the projected image.

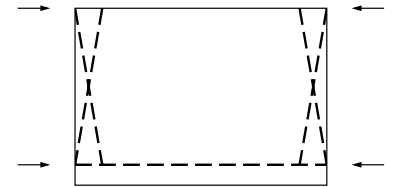

Keystoned image

### Moving the projector

- Press the Standby/On button to switch off the projector. The power will turn off and the Standby/On indicator will blink orange for 1 minute before the standby status will be activated. (The exhaust fan will continue to run for a while for cooling purposes)
- Wait until the cooling fan has stopped (about 3 minutes after the projector has been switched off) and disconnect the power cord and all other cables.
- Slide the lens cap back in place to prevent dust, dirt or other contamination from harming or damaging the front of the projector lens when moving the projector.

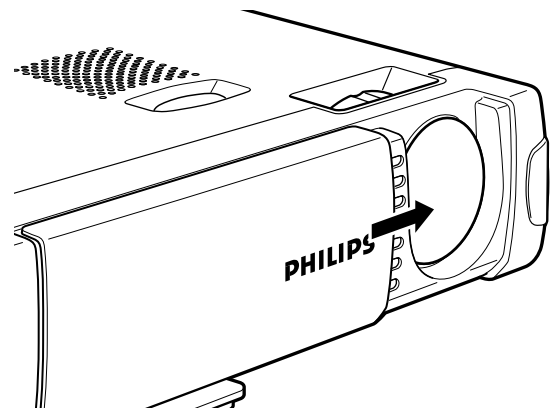

**Note:** Never place the projector on the back where the connections are located.

## 6. Set Up

### Inserting the batteries in the remote control

1. Press firmly and slide the battery cover off.

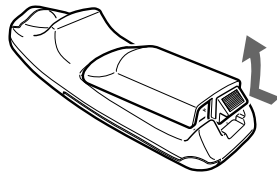

2. Insert the two supplied batteries (size AAA1,5V/LR03). Ensure that the polarities (+ and -) of the batteries are aligned correctly.

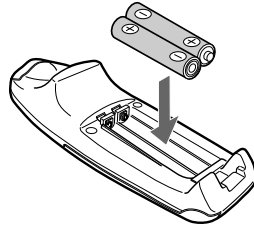

3. Slide the cover back until it snaps into place.

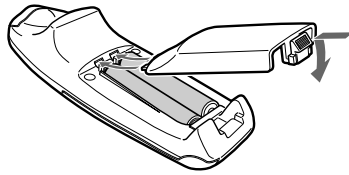

#### Caution!

Do not mix old and new batteries (also never mix alkaline and manganese batteries).

### Using the remote control as PC mouse

The remote control of this projector can be used as the PC mouse (wireless mouse function) by connecting the Mouse connector of this projector and the PC. The PC Mouse functions of the Remote Control function after pushing the Mouse button on the RC Unit.

#### Remote control mouse functions



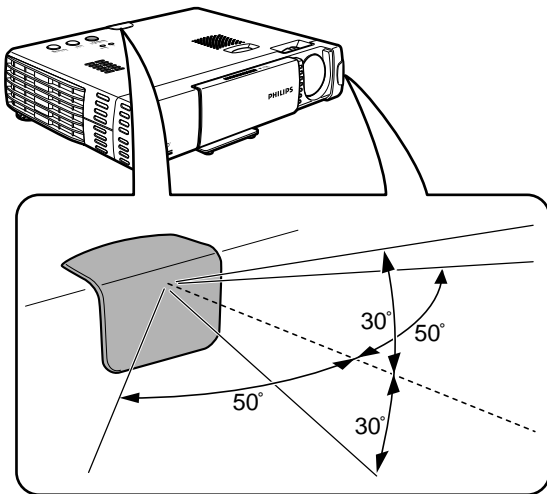





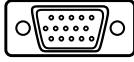
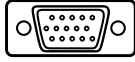
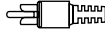

- The cursor key on the remote control operates the computer mouse functions.
- If a computer running Windows is connected, the OK button on the remote control operates as the computer mouse left click button and the Cancel button as the computer mouse right click button.
- If a Macintosh computer is connected, the OK and CANCEL buttons operate in the same way as the computer mouse click button.

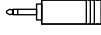

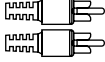
**Note:** The remote sensors are located on the front and back of the projector. The controllable range is 50 degrees horizontally and 30 degrees vertically relative to a line that is at a right angle to the remote sensor. And the distance between the point of the remote control and remote sensor must be shorter than four meters (13 feet).

## 7. Installation

## Video/computer cables and adapter

No.	CABLE	CONNECTIONS			
		Projector side		Computer/AV products side	
1	Computer VGA Cable	Mini D-Sub 15P (male)			Mini D-Sub 15P (male)
2	RCA Video Cable	RCA pin (male)			RCA pin (male)
3	PC Audio Cable	3.5 mm stereo mini-jack (male)			3.5 mm stereo mini-jack (male)
4	Audio Conversion Cable	3.5 mm stereo minijack (female)			RCA pin (male) x2
5	Mouse Cable PS/2	Mini Din 9P (male)			PS/2 connector (male)
6	Mouse Cable USB	Mini Din 9P (male)			USB connector 4P (type A)
7	S-Video Cable	Mini Din 4P (male)			Mini Din 4P (male)

### Video/computer cables

These accessories (1 to 7) are supplied with the product for connecting the projector to computer/AV equipment. The numbers in the left-hand column correspond with the numbers in the connection diagrams on the following pages.

### Optional cables and adapter:

- Programmable VGA MAC adapter
- Component (YCbCr) cable
- Scart adapter

# 7. Installation

# Connecting to a computer

## Connecting to a computer

### General

- This projector can be used as a display for numerous applications by connecting the Data output connector of a PC to the Data/YCbCr jack of this projector and setting the Data/YCbCr connector to Data.

### Caution!

- The data input is suitable for both Apple Macintosh computers (Power Book and Power Mac) as well as for IBM compatible PCs.
- The data output of IBM compatible PCs can be connected directly to the projector using standard data cables.
- Apple Macintosh computers may need a conversion plug (optional) added to the standard data cable.
- The figures in brackets like **(1)** correspond to the figures in the accessories diagram on the previous page.
- The figures in circles like **(3)** correspond to the characters in **fig. 2** of 'Controls and connections'.
- Either read the instruction manual or contact the manufacturer concerning the method used to set your PC.

### PC (Personal computer) / Macintosh

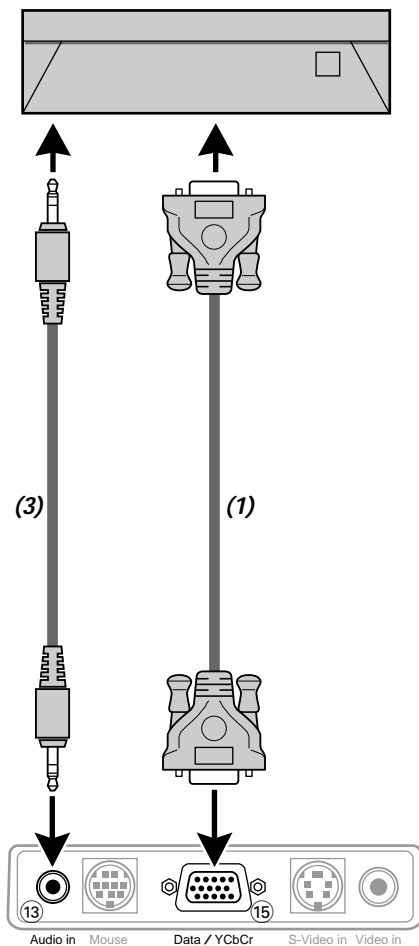

1. Connect the DATA OUT terminal of the computer to the Data/YCbCr terminal (15) of the projector and secure the plugs by tightening the thumb screws.  
For this, use the VGA cable **(1)** (supplied).  
When connecting the projector to a Macintosh computer use the VGA/MAC adapter (optional).
2. Connect the audio OUT socket of the computer to the Audio in socket (13) of the projector.  
For this, use the PC audio cable **(3)** (supplied).

## Connecting to PC mouse connector

### General

- The remote control of this projector can be used as the PC mouse (wireless mouse function) by connecting the Mouse connector of this projector to the corresponding connector of the PC.

### Caution!

- Before connecting, turn off the PC power. Turn off the power of this projector if it is on.
- When connection is completed, turn on the power of this projector and then start the PC.

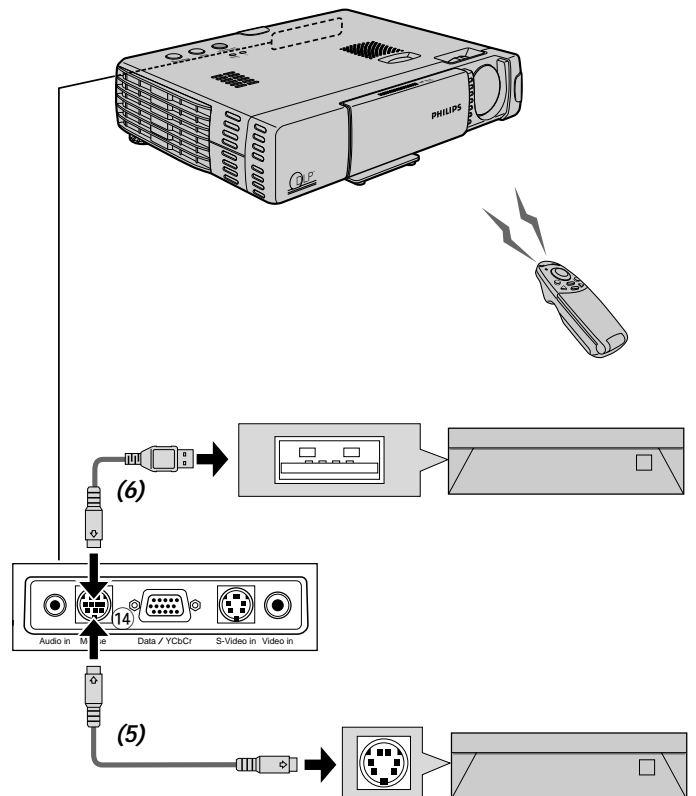

**Note:** Depending on the PC, the mouse may not be recognized in some cases if not connected to the Mouse connector before the PC power is turned on.  
In the case of some notebook and laptop type PCs, it may not be possible to use the standard pointing device (track ball, etc.) of the PC when connected to the Mouse connector. In such case, it will not be possible to use the pointing device until the PC is rebooted, even if disconnected from the Mouse connector.

## 7. Installation

## Connecting to video equipment

### Connecting to video equipment

#### General

- You can connect up to two pieces of video equipment to the projector following the illustrations below.
- You can switch the input source to Video or S-Video when you connect two pieces of equipment. (The S-Video connection provides more vivid color and higher resolution compared to the composite Video in (17) connection.)
- You can output the sound of only one component through the projector speaker even when two components are connected. When connecting two external projectors, the audio from either one of these projectors can be output from the speaker of the projector. Audio can be turned on and off for video related input (Video, S-Video) or Data (or YCbCr) input from the menu (see SOUND MUTE on page 20).
- The figures in brackets like (2) correspond to the figures in the accessories diagram. The figures in circles like (3) correspond to the figures in fig. 2 of 'Controls and connections'.

#### Caution!

Always switch off the projector before making any connections.

#### COMPOSITE VIDEO SIGNAL

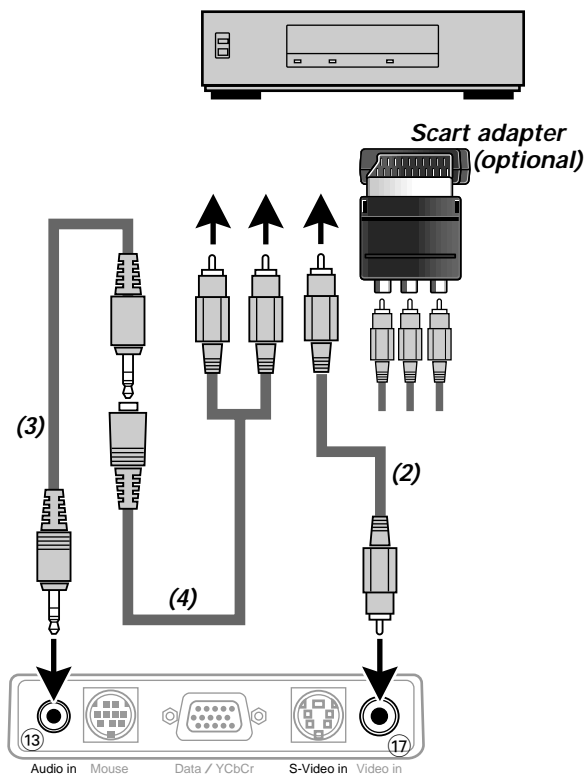

1. Connect the video OUT socket of a VCR, Laser Disc player, video camera or TV to the Video in socket (17) of the projector. For this, use the video connection cable (2) (supplied).
2. Connect the audio OUT L/R sockets of the VCR, Laser Disc player, video camera or TV to the AUDIO socket (13) of the projector. For this, use the audio connection cable (3) and the audio conversion cable (4) (supplied). Insert the white plug into the L socket and the red plug into the R socket.

#### In case your VCR, Laser Disc player, video camera or TV is equipped with a Scart connector (depending on region):

1. Connect the Scart/RCA Audio Video adapter (optional) to the Scart connector of the VCR, Laser Disc player, video camera or TV.
2. Plug the video/audio connection cables (2, 3 and/or 4) (supplied) into both the adapter and the Video socket (17) and Audio socket (13) of the projector.

#### S-VIDEO SIGNAL

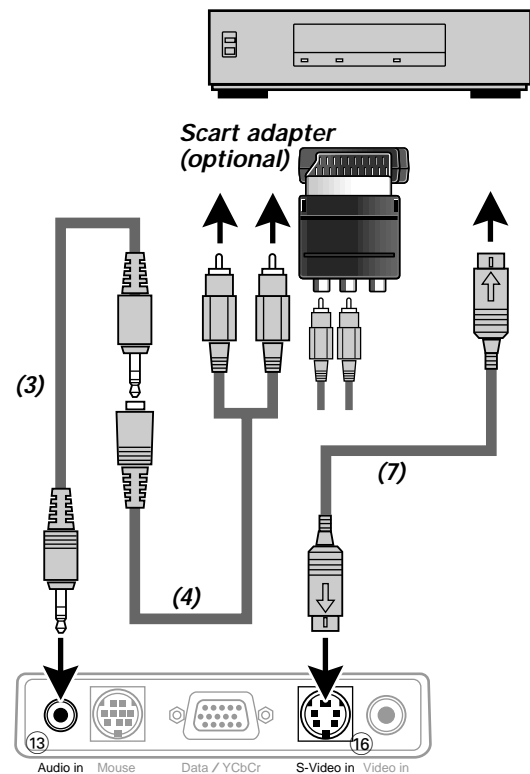

1. Connect the S-Video OUT socket of a S-VHS VCR, DVD, Laser Disc player, video camera or TV to the S-Video in socket (16) of the projector. For this use the S-Video connection cable (supplied).
2. Connect the audio OUT L/R sockets of the S-VHS VCR, DVD, Laser Disc player, video camera or TV to the Audio in socket (13) of the projector. For this, use the red and white audio connectors of the audio conversion cable. Insert the white plug into the L socket and the red plug into the R socket.

#### In case your VCR, Laser Disc player, video camera or TV is equipped with a Scart connector (depending on region):

1. Connect the Scart/RCA Audio Video adapter (optional) to the Scart connector of the VCR, Laser Disc player, video camera or TV.
2. Plug the audio connection cables (supplied) into both the adapter and the Audio in socket (13) of the projector. Insert the white plug into the L socket and the red plug into the R socket.
3. Plug the S-Video connection cable (supplied) into the VCR and the S-Video in socket (16) of the projector.

## COMPONENT VIDEO SIGNAL (YCbCr)

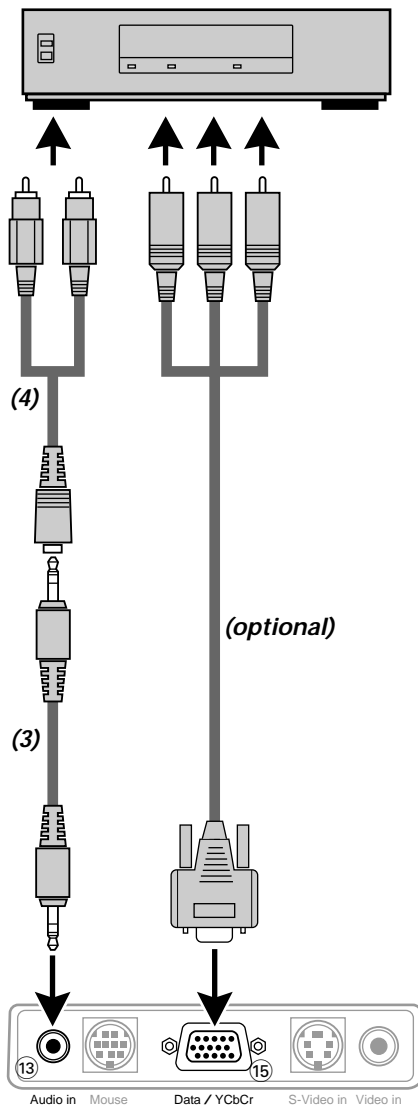

1. To use YCbCr component video input, set 'SOURCE CHANGE' under 'COLOR' in the Advanced menu to 'YCbCr' (See page 20).
2. Connect the Y (green), Cb (blue) and Cr (red) connectors of a DVD player or other component video equipment to the corresponding Data/YCbCr connector 15 of the projector. For this, use a YCbCr Component cable (optional).
3. To use the built-in audio system, connect one end of the computer audio cable (3) to the Audio in terminal 13 on the projector. Connect the other end (4) to the Audio output terminal on the video source.

## Preparation

### General

- Press the Standby/On button to switch on the projector.
  - The Standby/On indicator flashes green and the start up screen appears for 5 seconds.
  - After the lamp has been operating for 1000 hours or longer, the Status indicator will light and the "LAMP USAGE" icon which shows hours of total lamp usage will be displayed on the screen. When this happens, turn off the projector and replace the lamp cartridge with a new one. The projector will not turn on after 1100 hours. (It will turn off if it is in use) For lamp cartridge replacement see the section under Maintenance.
- When the lamp is on, the Standby/On indicator lights up green.
- Select the required source (Data/YCbCr, Video or S-Video) by pressing the Input selection button on the projector or the Video/Data buttons on the remote control.



**Note:** The Input selection button on the projector toggles between Data/YCbCr, Video or S-Video input.

- Switch on the PC or start video playback.
  - A feedback message appears on the screen, indicating the selected source.

### Feedback messages - General explanation

Feedback messages are displayed in the center of the screen. They are displayed when:

- a signal comes up or goes down,
- when an input source is changed,
- when the A/V Mute is addressed,
- when the Auto image function is set to ON.

These messages will only be displayed when the menu option FEEDBACK is set to 'ON' in the SETTINGS menu. All messages, except the A/V Mute message, will be removed automatically after 4 seconds.

Some examples:

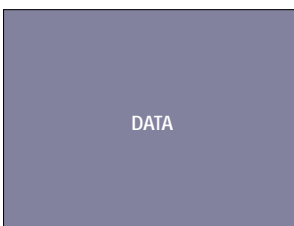

Data selected as source

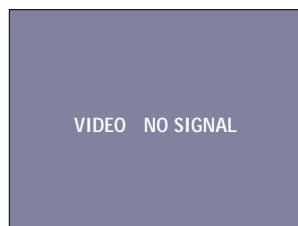

Video selected as source, no input signal.

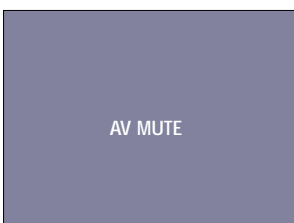

Data, Video or S-Video selected as source, A/V muted

### On Screen Display menu - General explanation

All video and data adjustments and settings (except A/V Mute) are done via On Screen Displays and with help of Menu and Cursor Control on the remote control. The basic settings, concerning image and lamp usage, are presented in the normal menu. This menu will be displayed when the Menu button is pressed with the remote control Flip cover closed.

Advanced feature settings are presented in the advanced menu. This menu will be displayed when the Menu button is pressed with the remote control Flip cover open.

- Press Menu.
  - The menu bar appears on the screen. The first item is highlighted and its sub menu is shown.
- Use Cursor Control left and/or right to move the cursor to any other item in the menu bar.
- Select the sub menu item to be adjusted using Cursor Control up and/or down.
- Adjust the selected item, using Cursor Control left and/or right.
- Press OK to confirm and store this adjustment.
- Select the next item to be adjusted in the sub menu and adjust as described above.
- Press Cancel to close the On Screen Display.

### Language selection

The projector can display menus in one of eight different languages.

- Open Flip cover and press Menu.
  - The menu bar appears on the screen.
- Use Cursor Control to select OPTION in the menu bar.
- Use Cursor Control to select LANGUAGE from the sub menu.
- Press OK to confirm the language selection menu.
- Use Cursor Control to select the required language in the action window.
- Press OK to confirm and store the selected language.
- If required, select the next item to be adjusted or press Cancel to exit the menu setting mode.

**Note:** The menu disappears automatically after the time, that has been set in DISPLAY TIME setting, is passed.

# 8. Operation

# Menu structure - data input

Data mode - Normal menu  
flip cover closed



IMAGE	INFORMATION	
BRIGHTNESS	0	
CONTRAST	0	
PICTURE ADJ	0	
FINE PICTURE	0	
-POSITION-		

IMAGE	INFORMATION	
-RESET-		
-LAMP USAGE HOURS RESET-		
RESOLUTION	1024 X 768	
FREQUENCY	H: 48.4 KH z	V: 60 Hz
LAMP USAGE	34	STATUS -0.02 12

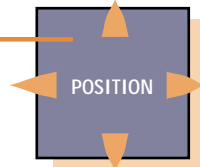

**Note:** The IMAGE and INFORMATION features are also accessible in the Advanced menu.

Data mode - Advanced menu  
flip cover open



IMAGE	COLOR	VIEW	SET UP	OPTION	INFO.
V-EFFECT		NORMAL	NATURAL	REAL	CUSTOM
COLOR TEMP.	LOW		MIDDLE	NORMAL	HIGH
SOURCE CHANGE			DATA		YCbCr

INDEX	1	
RED	0	
GREEN	0	
BLUE	0	

RED	0	
GREEN	0	
BLUE	0	

IMAGE	COLOR	VIEW	SET UP	OPTION	INFO.
ASPECT	REAL	AUTO	DIRECT		4:3>16:9
FILTER	1				
D-KEystone	NORMAL		FULL		
-PAN-					

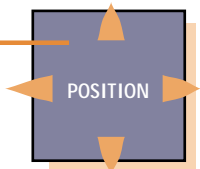
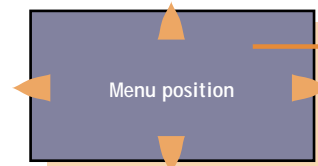

IMAGE	COLOR	VIEW	SET UP	OPTION	INFO.
SOUND MUTE			OFF		ON
BACKGROUND			BLUE		BLACK
AUTO GAIN			OFF		ON
AUTO SOURCE			OFF		ON
-PROJECTION-					
AUTO POWER OFF			OFF		ON

NORMAL					
VERTICALLY + HORIZONTALLY					
REVERSED HORIZONTALLY					
REVERSED VERTICALLY					

IMAGE	COLOR	VIEW	SET UP	OPTION	INFO.
-LANGUAGE-					
-MENU POSITION-					
MENU TYPE		TRANSLUCENT		OPAQUE	
DISPLAY TIME				30 SEC	
ON SCREEN		OFF		ON	

ENGLISH					
Deutsch					
Français					
ITALIANO					
Español					
Svenska					
中文					
日本語					





# 8. Operation

# Menu structure - video input

Video mode - Normal menu  
flip cover closed



IMAGE	INFORMATION	
BRIGHTNESS	0	
CONTRAST	0	
COLOR	0	
TINT	0	
SHARPNESS	1	

IMAGE	INFORMATION	
-RESET-		
-LAMP USAGE HOURS RESET-		
LAMP USAGE	34	STATUS 21212.13361

**Note:** The IMAGE and INFORMATION features are also accessible in the Advanced menu.

Video mode - Advanced menu  
flip cover open



IMAGE	COLOR	VIEW	SET UP	OPTION	INFO.
V-EFFECT		NORMAL	NATURAL	REAL	CUSTOM
COLOR TEMP.		LOW	MIDDLE	NORMAL	HIGH
VIDEO TYPE			DVD		VCR
-COLORSYSTEM-					
SOURCE CHANGE			DATA		YCbCr

INDEX	1	
RED	0	
GREEN	0	
BLUE	0	

RED	0	
GREEN	0	
BLUE	0	

AUTO	
	NTSC
	NTSC 4.43
	PAL
	PAL M
	PAL N
	PAL60
	SECAM

IMAGE	COLOR	VIEW	SET UP	OPTION	INFO.
ASPECT		REAL	AUTO	DIRECT	4:3>16:9
FILTER		1			
D-KEystone		NORMAL		FULL	

IMAGE	COLOR	VIEW	SET UP	OPTION	INFO.
SOUND MUTE			OFF		ON
BACKGROUND			BLUE		BLACK
AUTO GAIN			OFF		ON
AUTO SOURCE			OFF		ON
-PROJECTION-					
AUTO POWER OFF			OFF		ON

NORMAL	
	VERTICALLY + HORIZONTALLY
	REVERSED HORIZONTALLY
	REVERSED VERTICALLY

IMAGE	COLOR	VIEW	SET UP	OPTION	INFO.
-LANGUAGE-					
-MENU POSITION-					
MENU TYPE		TRANSLUCENT		OPAQUE	
DISPLAY TIME				30 SEC	
ON SCREEN		OFF		ON	

ENGLISH	
	Deutsch
	Français
	ITALIANO
	Español
	Svenska
	中文
	日本語

Menu position
---------------

**General**

The projector's picture is set to standard specifications at the factory. However, you can adjust the image to suit your own preferences. The projector will store the last used settings for every source. So when you switch from one source to another, the settings of the source switched from will be stored and the settings of the source switched to will be recalled. When the projector is switched off and on again the settings for the selected source will be recalled again.

**Direct access projector functions via the remote control unit****Digital features- for data and video/s-video signal input:**  
(Open the Flip cover of the remote control unit)– **D-Freeze (Digital Freeze)**

A still image of the current frame is displayed. To restore the present picture, press the button again;

– **D-Zoom (Digital Zoom)**

While the button is pressed the picture is enlarged until it becomes ten times the original size. Release the button at the desired size. To reduce the size of the projected image: press D-Zoom – button. When this button is released, the screen will return to 80% reduction;

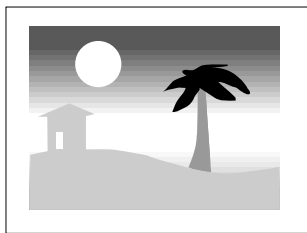
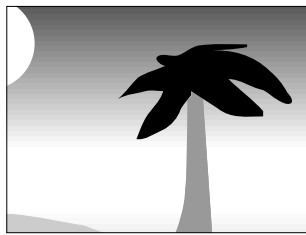
– **D-Keystone (Digital Keystone)**

Corrects picture distortion of the vertical keystone type by internal scaling.

**Audio volume control**– **VOLUME**

The audio volume via the built-in speaker can be adjusted with the Volume +/- buttons on the remote control;

– **A/V MUTE**

By pressing the A/V Mute button on the Remote control unit, the image will turn off and the sound is muted at the same time. To restore the picture and sound, press the button again.

**Digital features- for data signal input only:**– **AUTO (Auto image)**

This function can be activated by pressing the Auto image button on the local keyboard or on the remote control unit. The auto image function automatically sizes and positions the image to fit optimally in the screen picture in accordance with the resolution. In addition it takes care for phase adjustment. It does not affect the selected picture format. In case after the Auto image setting the picture still is not of satisfactory performance, manual setting for possible further improvement can be made. For details see 'Data mode - Normal menu'.

**Note:** In case the Auto image feature is addressed in Video mode, the picture will mute for a short while. No setting of Auto image will take place in Video mode.

**Menu access of projector functions****DATA MODE - NORMAL MENU**

Press the Menu button *with the flip cover of the remote control closed*, to display the advanced menu, then use the cursor key (up/down) to select the display and picture control functions. After selection of the required function, set the required value setting by means of the cursor key (left /right).

**IMAGE (Picture control)**– **BRIGHTNESS**

Adjusts brightness of the displayed picture;

– **CONTRAST**

Adjusts the overall contrast intensity;

– **PICTURE ADJ. (Size)**

Adjusts the computer image in a horizontal direction to make the image completely fit the screen. Adjustment is performed in dot units. Adjust to the position where vertical flicker disappears.

The HORIZONTAL SIZE function is used to size a computer image to make it fit the projected picture, both horizontally and vertically. The horizontal size parameter has permanent scope. When the OSD menu is active and the horizontal size option is selected, the level will be indicated graphically on a linear scale (gauge). The default output level conforms to the value set by the AUTO IMAGE function. Switching to another data mode automatically restores AUTO IMAGE if the data mode is not part of the ten most recently used display modes;

– **FINE PICTURE (Phase)**

Press the cursor key to the left or right and adjust to minimize image noise, flicker, color variations, etc.;

– **POSITION**

Adjusts the computer image in horizontal and vertical direction to centre it on the screen.

To activate the POSITION setting, press the OK button on the remote control when POSITION is addressed in the IMAGE setting menu. With the cursor key you can move the picture in the required position.

**Tip for Windows users:**

To adjust size and phase correctly:

1. Select 'Start' and then 'Shut down'.
2. Adjust the projector's size control, so that no vertical bars are visible.
3. Now adjust the projector's phase control for maximum brightness of the projected image.
4. Press 'No' in the Windows shutdown screen to cancel the shutdown action.

## 8. Operation

## Display and picture control

### DATA MODE - ADVANCED MENU

Press the Menu button *with the flip cover of the remote control open*, to display the advanced menu. Use the cursor key (up/down) to select the display and picture control functions. After selection of the required function, set the required value setting by means of the cursor key (left/right).

#### IMAGE (Picture control)

- **BRIGHTNESS**  
Adjusts brightness of the displayed picture;
- **CONTRAST**  
Adjusts the overall contrast intensity;
- **PICTURE ADJ. (Size)**  
Adjusts the computer image in a horizontal direction to make the image completely fit the screen. Adjustment is performed in dot units. Adjust to the position where vertical flicker disappears.  
The HORIZONTAL SIZE function is used to size a computer image to make it fit the projected picture, both horizontally and vertically. The horizontal size parameter has permanent scope. When the OSD menu is active and the horizontal size option is selected, the level will be indicated graphically on a linear scale (gauge). The default output level conforms to the value set by the AUTO IMAGE function. Switching to another data mode automatically restores AUTO IMAGE if the data mode is not part of the ten most recently used display modes;
- **FINE PICTURE (Phase)**  
Press the cursor key to the left or right and adjust to minimize image noise, flicker, color variations, etc.;
- **POSITION**  
Adjusts the computer image in horizontal and vertical direction to centre it on the screen.  
To activate the POSITION setting, press the OK button on the remote control when POSITION is addressed in the IMAGE setting menu. With the cursor key you can move the picture in the required position.

#### COLOR

- **GAMMA**  
The following can be selected.
  - NORMAL is standard setting
  - NATURAL stresses coloring
  - REAL stresses brightness
  - CUSTOM is used to adjust freely as desired. Personal setting can be made of the color gamma index, and the respective R,G and B levels.  
To activate the CUSTOM setting, press the OK button on the remote control when CUSTOM is addressed in the COLOR setting menu. With the cursor key you can make your desired personal setting;
- **COLOR TEMP. (Color temperature)**  
Adjusts the overall picture impression from warm to cool. Four different types of color balance can be set beforehand: LOW, MEDIUM, STANDARD and HIGH. Personal settings can be made to set the resp. R,G and B levels.  
To activate the personal setting, press the OK button on the remote control when the color balance setting is selected. With the cursor key (left/right) you can make your desired personal setting;
- **SOURCE CHANGE**  
For changing the possible input signal acceptance via the Data input connector
  - Data for standard PC signals
  - YCbCr for component video signals (DVD)

#### VIEW

- **ASPECT**  
To set the aspect ratio. Four different settings can be selected for images:
  - REAL: input signal projection without pixel replacement;
  - AUTO: projection after automatic input signal zoom-in / zoom-out;
  - DIRECT: the original aspect ratio of the image is maintained at all times;
  - 4:3 > 16:9: 4:3 aspect ratio images are projected after conversion to the 16:9 aspect ratio.
- **FILTER**  
To set the sharpness during pixel conversion (image compression/enlargement);
- **KEystone**  
Corrects picture distortion of the vertical keystone type by internal scaling;
  - NORMAL
  - FULL
- **PAN**  
To move to the desired portion of the enlarged picture press the desired portion of the cursorkey. The available directions are indicated by the four large triangle marks on the cursor key. The picture will move in the direction of the mark you are pressing.

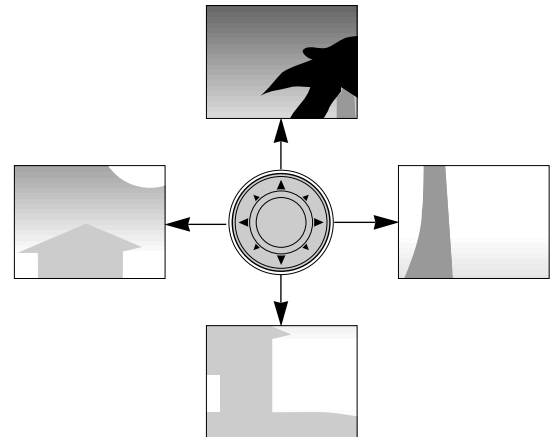

**Note:** Less than the original size of the picture cannot be moved because the whole image is fully displayed.

### VIDEO/S-VIDEO MODE - NORMAL MENU

Press the Menu button *with the flip cover of the remote control closed*, to display the advanced menu, then use the cursor key (up/down) to select the display and picture control functions. After selection of the required function, set the required value setting by means of the cursor key (left/right).

#### IMAGE (Picture control)

- **BRIGHTNESS**  
Adjusts brightness of the displayed picture;
- **CONTRAST**  
Adjusts the overall contrast intensity;
- **COLOR (Saturation)**  
Adjusts the color saturation of the projected image;
- **TINT**  
Adjusts the tint of the projected image;
- **SHARPNESS**  
Controls the contour impression of the picture.

### VIDEO/S-VIDEO MODE - ADVANCED MENU

Press the Menu button *with the flip cover of the remote control open*, to display the advanced menu. Use the cursor key (up/down) to select the display and picture control functions. After selection of the required function, set the required value setting by means of the cursor key (left /right).

#### IMAGE (Picture control)

- **BRIGHTNESS**  
Adjusts brightness of the displayed picture;
- **CONTRAST**  
Adjusts the overall contrast intensity;
- **COLOR (Saturation)**  
Adjusts the color saturation of the projected image;
- **TINT**  
Adjusts the tint of the projected image;
- **SHARPNESS**  
Controls the contour impression of the picture.

#### COLOR

- **GAMMA**  
The following can be selected.
  - NORMAL is standard setting
  - NATURAL stresses coloring
  - REAL stresses brightness
  - CUSTOM is used to adjust freely as desired. Personal setting can be made of the color gamma index, and the respective R,G and B levels.  
To activate the CUSTOM setting, press the OK button on the remote control when CUSTOM is addressed in the COLOR setting menu. With the cursor key you can make your desired personal setting;
- **COLOR TEMP. (Color temperature)**  
Adjusts the overall picture impression from warm to cool. Four different types of color balance can be set beforehand: Low, Medium, Standard and High. Personal settings can be made to the resp. R,G and B levels.  
To activate the personal setting, press the OK button on the remote control when the color balance setting is selected. With the cursor key you can make your desired personal setting;
- **VIDEO TYPE**  
For selecting input signal.
  - DVD Video for DVD players;
  - VIDEO for normal video players.

**Note:** When 'DVD' is selected, SHARPNESS can not be adjusted.

- **COLOR SYSTEM**  
The following color systems can be used with this projector:
  - NTSC 3.58
  - NTSC 4.43
  - PAL
  - PAL-M
  - PAL-N
  - PAL60
  - SECAM
 To activate the color system setting, press the OK button on the remote control when COLOR SYSTEM is addressed in the COLOR setting menu. With the cursor key you can select the desired color system;

**Note:** Only the NTSC 3.58 and PAL can be used for component video; The selection is automatic when AUTO is used.

- **SOURCE CHANGE**  
For changing the possible input signal acceptance via the Data input connector
  - Data for standard PC signals
  - YCbCr for component video signals (DVD)

#### VIEW

- **ASPECT**  
To set the aspect ratio. Four different settings can be selected for images:
  - REAL: input signal projection without pixel replacement;
  - AUTO: projection after automatic input signal zoom-in / zoom-out;
  - DIRECT: the original aspect ratio of the image is maintained at all times;
  - 4:3 > 16:9: 4:3 aspect ratio images are projected after conversion to the 16:9 aspect ratio
- **FILTER**  
To set the sharpness during pixel conversion (image compression/enlargement);
- **KEYSTONE**  
Corrects picture distortion of the vertical keystone type by internal scaling;
  - NORMAL
  - FULL

#### Other Settings

---

The projector is equipped with the following functions to optimize its use and handling:

#### SET UP (Set up changings)

With the Flip cover of the remote control open press the Menu button to display the advanced menu, then use cursor control (left/right) to select SETUP selection functions. Use the cursor up/down keys to select the required setup setting. After selecting the required setup function, set the required value setting by means of cursor control (left/right).

- **SOUND MUTE**  
Audio only can be muted for each input. This function is convenient when multiple video units are connected to this projector.  
Select the input to be muted:
  - OFF
  - ON

**Note:** The volume can also be adjusted with the - VOLUME + buttons on the remote control.

- **BACKGROUND**  
Two different backgrounds can be selected for projection when there is no signal input.
  - BLUE
  - BLACK
- **AUTO GAIN**  
Brightness and contrast are adjusted automatically.
  - OFF
  - ON
- **AUTO SOURCE**  
Automatically searching the input signal.
  - ON: - all input signals are searched
  - OFF: - remote control Video button: Video and S-Video are searched;
  - remote control Data button: Data and YCbCr signals are searched;
  - main unit Input button: All input signals are searched individually.

- **PROJECTION**

The projector can be used in various positions with respect to the viewers and the projection screen. With the PROJECTION function via setup menu the picture can be displayed in a way that is suitable for a specific application. Use the cursor / keys to select a projection type in accordance with the set conditions. The setting items will change as shown below each time a key is pressed.

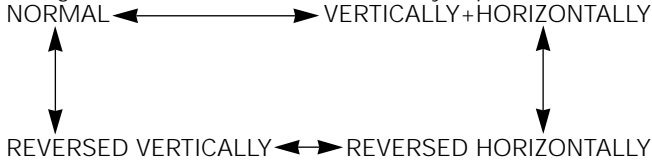

**NORMAL (table projection)**

The image can be flipped to a horizontal mirror image of the input signal for rear screen projection.

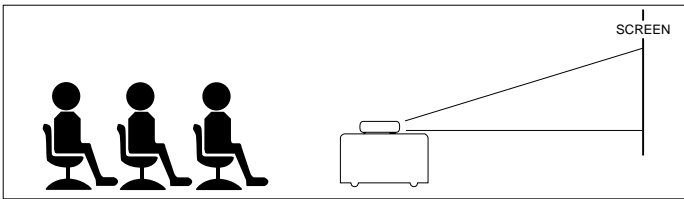

**REVERSED HORIZONTALY (rear table projection)**

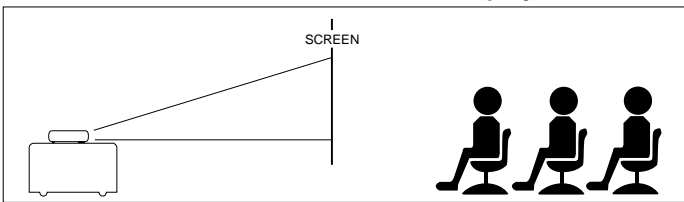

- **AUTO POWER OFF**

When there is no signal input for a period of 5 min. or more, the power is automatically turned off and standby status is activated.

- OFF
- ON

**OPTION (Option changings)**

With the Flip cover of the remote control open press the Menu button to display the advanced menu, then use cursor control (left/right) to select OPTION selection functions.

Use the cursor up/down keys to select the required option setting. After selection of the required option, set the required value setting by means of cursor control (left/right).

- **LANGUAGE (Language selection)**

To activate the Language selection, press the OK button on the remote control when LANGUAGE has been addressed in the OPTION setting menu. Use the cursor key to select one of the following languages:

- English
- German
- French
- Italian
- Spanish
- Swedish
- Chinese
- Japanese

- **MENU POSITION (Menu Display Position)**

The menu display position can be set with this function. To activate the MENU POSITION feature, press the OK button on the remote control when MENU POSITION has been addressed in the OPTION setting menu. With the cursor key you can move to menu to any desired position;

- **MENU TYPE (Menu Viewing Settings)**

The menu viewing method can be set with this function.

- TRANSLUCENT
- OPAQUE

- **DISPLAY TIME**

The time that the menu is displayed on the screen can be set with this function.

- Value can be set from 5 sec to 30 sec (in steps of 5 seconds).

- **ON SCREEN**

This function is set to ON at the factory. When set to ON, input will be projected onto the screen for a period of 3 sec. when the input is switched with the remote control button. Also, the Input menu will be displayed for approximately 20 sec. when the power is turned on to indicate the selected input. In addition, status is displayed on the menu bar when D-Freeze, A/V Mute, D-Zoom, D-Keystone or Volume is set.

- ON
- OFF

**INFO (Information)**

- **RESET**

This function is used to reset all user settings to the default factory settings.

1. Press Menu.
- The menu bar appears on the screen.
2. Use Cursor Control to move the cursor to INFORMATION.
3. Select RESET by using Cursor Control.
4. Press OK

- **LAMP USAGE HOURS RESET**

This function is used to reset the hours of lamp usage after replacing the lamp.

# 9. Maintenance

## Cleaning

1. Press the Standby/On button to switch off the projector.
  - The standby indicator lights up red.
2. Wait until the cooling fan has stopped (about 3 minutes after the projector has been switched off) and disconnect the power cord and all other cables.
3. Turn the projector over. *Never place the projector on the side where the connections are located!*

- Use a blower or lens paper to clean the lens, and be careful not to scratch or mar the lens.

### Caution!

Switch off and disconnect the projector before cleaning.

1. When the cabinet is dusty, clean it by gently wiping with a soft cloth.
2. A chamois leather slightly moistened with water is sufficient for cleaning the housing.
3. If heavily soiled, use a mild detergent. Never use strong detergents or solvents such as alcohol or thinner.

## Always keep the lens clean

1. When the lens is dirty or dusty, first blow the dust off and then gently wipe with a soft brush or lens cleaning paper. Never touch the lens with your fingers.
2. The lens is likely to become mouldy if left dirty.

## Cleaning the ventilation slots

1. Clean the ventilation slots and speaker grills on the unit periodically using a vacuum cleaner. Use a soft brush attachment when using the vacuum cleaner. Do not use a hard attachment, such as a crevice tool, to prevent the damage to the unit.
2. If accumulated dust blocks the ventilation slots, the unit will overheat, which may cause the unit to malfunction.

## Lamp

The lamplife remaining can be checked using the OSD menu.

1. Press the Menu.
  - The menu bar appears on the screen.
2. Use Cursor Control to move the cursor to INFORMATION.
3. Use Cursor Control to select LAMP USAGE HOURS RESET and then press OK.

The power will not turn on when the lamp hours of usage has exceeded 1100 hours. Thus, the menu cannot be displayed. In such case, replace the lamp housing, then use the following procedure to reset.

1. Connect the power cord.
  - Standby status will be activated.
2. Press the Input and Auto image buttons of the main unit at the same time for 5 sec. or more. The lamp hours of usage will be reset. After resetting, the Status indicator that turned on because 1100 hours had been exceeded will turn off.

**Note:** Obtain a replacement lamp cartridge at the store where the unit was purchased. Please specify the following information when ordering a replacement lamp cartridge:

- Model name : LC5141 (XGA) / LC5131(SVGA)
- Lamp typeLCA 3113; 12nc: 8670 931 13009

## Lamp replacement

Be sure to replace the lamp when the Status indicator comes on. If you continue to use the lamp after 1000 hours of usage, the lamp will turn off.

1. Press the Standby/On button to switch off the projector.
  - The standby indicator lights up red.
2. Wait at least 1 hour for the lamp to cool down and the cooling fan to stop and disconnect the power cord and all other cables.
3. Turn the projector over. *Never place the projector on the side where the connections are located!*
4. Loosen the lamp cover securing screw.
5. Remove the lamp cover.

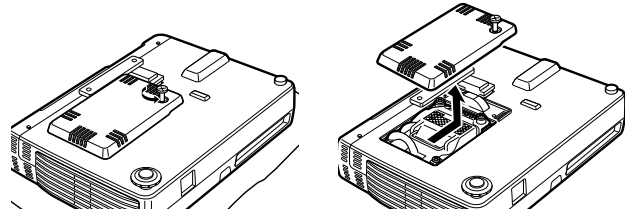

6. Loosen the three lamp cartridge securing screws. (This unit has a safety switch.)
7. Grasp the lamp holder handle and carefully pull the lamp holder out of the projector.

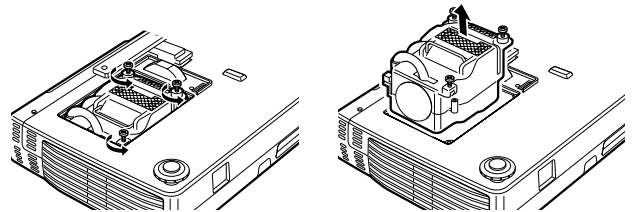

8. Carefully remove the new lamp housing from its package. Do not touch lamp or point lamp housing opening at anyone. Do not drop, as the impact may cause the lamp to break.
9. Place the lamp holder in the guiding slots and insert into the lamp compartment.
10. Secure the lamp cartridge with the three screws.

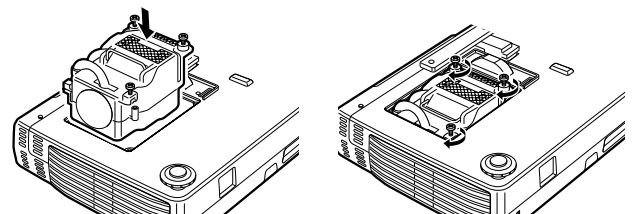

11. Replace the lamp cover and secure it with the securing screw.

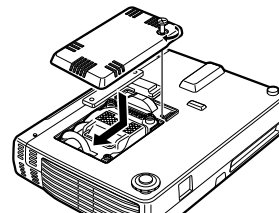

12. Return the unit to the normal position, connect the power cable, and turn on the unit.
13. Reset LAMP HOURS RESET USAGE.

## 9. Maintenance

### **Caution!**

- Do not use a lamp cartridge other than the Philips replacement lamp cartridge. Order this from your Philips dealer using the unit model number (see 'Note' under 'Lamp').
- Be very careful. The lamp and lampholder may still be too hot to touch.
- Do not loosen any screws except for those mentioned in the instructions below. There is danger of electric shock.
- Keep lamp holder opening to your right. Do not touch lamp or point lamp holder opening at anyone.
- A high-pressure lamp may break if handled improperly.

### **Resetting the lamp life time**

---

The rated lamp life is about 1000 hours. The rated lamp life is the average life of the lamps produced and tested (under the test conditions of our company) for a long term, however, it may become shorter depending on the conditions of usage. After the lamp has been operating for 1000 hours or longer, the Status indicator on the control panel will light and the 'LAMP USAGE' icon which shows hours of total lamp usage will be displayed on the screen. When this happens, turn off the unit and replace the lamp cartridge with a new one. The unit will not turn on after 1100 hours. (It will go off if it is in use.)

1. Press Menu.
  - The menu bar appears on the screen.
2. Use cursor control to select INFORMATION in the menu bar.
3. Use cursor control to select LAMP COUNTER in the sub menu.
4. Press OK for 3 seconds to reset the lamp counter.
5. If required, select another item you wish to adjust or press Menu to exit.

# 10. Troubleshooting

If a fault occurs, first check the points listed below before taking the projector for repair. If you are unable to remedy a problem by following these hints, consult your dealer or service organisation.

### Warning:

Under no circumstances should you try to repair the projector yourself as this could invalidate the warranty.

### PROBLEM

- POSSIBLE CAUSE
- SOLUTION

#### The power will not turn on

- Is the power plug connected to the power outlet?
- Is the lamp cover correctly installed?
- Is the internal temperature too high? A protective feature prevents the power turning on when the internal temperature is too high.
- Has the lamp usage time exceeded 1100 hours? The power will not turn on when 1100 hours have elapsed.

#### No image

- Has the connected input been selected?
- Is the cable correctly connected to the input jack?
- Are the brightness and contrast set to minimum?
- Is the sliding lens cap closed?
- Is the lamp blown?
- Has the lamp usage time exceeded 1100 hours?
- If a notebook type computer is being used, was the computer power turned on after the projector was connected? Is the computer set to disable output to the external Data jack? In many cases, when a notebook type computer is connected to the projector, a signal will not be output to the Data OUT jack unless the computer power is turned on.
- Does the Status indicator blink?

#### Distorted images

- Is installation correct?
- Was the Keystone adjustment performed correctly?

#### Blurred images

- Is the lens properly focussed?
- Are the screen and projector positioned at the the correct angle?
- Does the projection distance place the screen outside the focus range?
- Is there condensation, dirt, etc., on the lens?  
Condensation on the internal optical system is possible when the projector has been stored in a cool place and then is used in a warm place. In such cases, wait several minutes for the condensation to evaporate.

#### Images are offset vertically or horizontally and are not correctly displayed

- Correctly adjust the horizontal and vertical position of the screen.
- Is the clock frequency correctly adjusted?
- Are the resolution and frequency correct for the input signal? Check the resolution of the PC.

#### The remote control does not work

- Does the send indicator (LED) light? If it does not light, the batteries are exhausted. In such cases, replace with fresh batteries.
- Is there any obstacle between the remote control and the photoreceptors of the main unit?
- Is the remote control being used outside its effective range?
- Is there a fluorescent light or other strong light source close to the photo receptor?

#### The wireless mouse does not work

- Are the Mouse jack of the main unit and the PC correctly connected?
- Was the PC started after being connected to the Mouse jack of the main unit?

#### The STATUS indicator blinks

- Check the Status indicator list.

#### Flickering text or offset colors with RGB input

- Manually adjust the clock frequency and phase.
- Press the Auto image button.

STATUS indicator list	
Condition	Status
OFF	Normal
On Continuously	The lamp usage has exceeded 1000 hours of operation and should be replaced.
Flashing Very Rapidly (On and off in a cycle of 1 sec.)	The lamp cover is not correctly attached. Replace it correctly.
Flashing Rapidly (On and off in a cycle of 4 sec.)	<ul style="list-style-type: none"> <li>• The temperature protector has been triggered. If the room temperature is high, move the unit (On and off in a cycle of 4 sec.) to a cool location. If the temperature within the unit is high, check the cooling fan ventilation slots and the ventilation slots on the bottom of the unit. If any of the slots are blocked, remove whatever is blocking them.</li> <li>• The temperature protector has been triggered. If you try to turn on the unit immediately after turning off, sometimes the power does not come on. If this happens, wait at least one minute, then turn on the unit again.</li> <li>• The lamp lighting voltage error detection protector has been triggered. Wait at least one minute before turning on the unit again. If this does not solve the problem, please contact your dealer.</li> </ul>
Flashing Slowly (On and off in a cycle of 8 sec.)	The cooling fan has stopped. Contact your Philips dealer for service.
Flashing Very Slowly (On and off in a cycle of 12 sec.)	The lamp is not turned on. <ul style="list-style-type: none"> <li>• The unit was turned on immediately after being turned off. Turn off the unit, wait at least one minute, then turn on the unit again.</li> <li>• The lamp is dead. Replace the lamp cartridge. (See 'Lamp replacement on page 22)</li> </ul>