

Register your product and get support at
www.philips.com/welcome

HTS5590W



EN User manual

ES Manual del usuario

PT-BR Manual do Usuário

PHILIPS

Contents

1 Notice	2	6 Change settings	20
Copyright	2	Access the setup menu	20
About Progressive Scan	2	Change video settings	20
Open source software	2	Change audio settings	21
Trademarks	2	Set up network	21
		Set up EasyLink	21
		Change preference settings	22
		Change advanced settings	22
2 Important	4		
Safety	4	7 Update software	23
Product care	4	Check software version	23
Disposal of your old product and batteries	5	Update software from the network	23
3D health warning	5	Update software from a USB	24
3 Your home theater	6	8 Product specifications	24
Main unit	6		
Remote control	6	9 Troubleshooting	26
4 Connect your home theater	9	10 Index	28
Connectors	9		
Connect to the TV	10		
Connect audio from TV or other devices	11		
Connect a wireless module	11		
Connect to a computer network and the Internet	12		
5 Use your home theater	13		
Before you start	13		
Access the home menu	13		
Choose your sound	13		
Play a disc	14		
Use BonusView on Blu-ray	15		
Access BD-Live on Blu-ray	15		
Play 3D video	15		
Play from a USB storage device	16		
More play features for disc or USB	16		
Play from PC (DLNA)	17		
Play from radio	18		
Play audio from TV or other devices	19		
Play from an MP3 player	19		
Play from an iPod or iPhone	19		
Use Philips EasyLink	19		

1 Notice

Copyright



Be responsible
Respect copyrights

This item incorporates copy protection technology that is protected by U.S. patents and other intellectual property rights of Rovi Corporation. Reverse engineering and disassembly are prohibited.

About Progressive Scan

Consumers should note that not all high definition television sets are fully compatible with this product and may cause artifacts to be displayed in the picture. In case of 525 or 625 progressive scan picture problems, it is recommended that the user switch the connection to the 'standard definition' output. If there are questions regarding our TV set compatibility with this model 525p and 625p DVD player, please contact our customer service center.

Open source software

Philips Electronics Singapore Pte Ltd hereby offers to deliver, upon request, a copy of the complete corresponding source code for the copyrighted open source software packages used in this product for which such offer is requested by the respective licenses. This offer is valid up to three years after product purchase to anyone in receipt of this information. To obtain source code, please contact open.source@philips.com. If you prefer not to use email or if you do not receive confirmation receipt within a week after mailing to this email address, please write in English to "Open Source Team, Philips Intellectual Property & Standards, P.O. Box 220, 5600 AE Eindhoven, The Netherlands". If you do not receive timely confirmation of your letter, please email to the email address above. The texts of the licenses and acknowledgements for open source software used in this product are included on a separate leaflet.

Trademarks



"Blu-ray 3D" and "Blu-ray 3D" logo are trademarks of Blu-ray Disc Association.



BONUSVIEW™

'BD LIVE' and 'BONUSVIEW' are trademarks of Blu-ray Disc Association.



Java and all other Java trademarks and logos are trademarks or registered trademarks of Sun Microsystems, Inc. in the United States and/or other countries.

AVCHD™

'AVCHD' and 'AVCHD' logo are trademarks of Matsushita Electric Industrial Co., Ltd and Sony Corporation.

x.v.Colour

'x.v.Colour' is a trademark of Sony Corporation.



DLNA®, the DLNA Logo and DLNA CERTIFIED® are trademarks, service marks, or certification marks of the Digital Living Network Alliance.

(For HTS5580W and HTS5590W only.)



Manufactured under licence from Dolby Laboratories. Dolby, Pro Logic, and the double-D symbol are trademarks of Dolby Laboratories.



Manufactured under license under U.S. Patent #'s: 5,451,942; 5,956,674; 5,974,380; 5,978,762; 6,226,616; 6,487,535; 7,392,195; 7,272,567; 7,333,929; 7,212,872 & other U.S. and worldwide patents issued & pending. DTS and the Symbol are registered trademarks, & DTS-HD, and DTS-HD Master Audio | Essential and the DTS logos are trademarks of DTS, Inc. Product includes software. © DTS, Inc. All Rights Reserved.



DivX®, DivX Certified® and associated logos are registered trademarks of DivX, Inc. and are used under license.

DivX Ultra® Certified to play DivX® video with advanced features and premium content.

ABOUT DIVX VIDEO: DivX® is a digital video format created by DivX, Inc. This is an official DivX Certified device that plays DivX video. Visit www.divx.com for more information and software tools to convert your files into DivX video.

ABOUT DIVX VIDEO-ON-DEMAND: This DivX Certified ® device must be registered in order to play DivX Video-on-Demand (VOD) content. To generate the registration code, locate the DivX VOD section in your device setup menu. Go to vod.divx.com with this code to complete the registration process and learn more about DivX VOD.



Windows Media and the Windows logo are trademarks, or registered trademarks of Microsoft Corporation in the United States and/ or other countries.



HDMI, and HDMI logo, and High-Definition Multimedia Interface are trademarks or registered trademarks of HDMI licensing LLC in the United States and other countries.



The USB-IF Logos are trademarks of Universal Serial Bus Implementers Forum, inc.

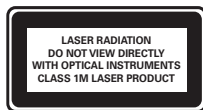

Philips
Modelo: HTS5590W



0827-10-4125



(01)07894401013539

"Este equipamento opera em caráter secundário, isto é, não tem direito a proteção contra interferência prejudicial, mesmo de estações do mesmo tipo, e não pode causar interferência a sistemas operando em caráter primário."

2 Important

Read and understand all instructions before you use your home theater. If damage is caused by failure to follow instructions, the warranty does not apply.

Safety

Risk of electric shock or fire!

- Never expose the product and accessories to rain or water. Never place liquid containers, such as vases, near the product. If liquids are spilt on or into the product, disconnect it from the power outlet immediately. Contact Philips Consumer Care to have the product checked before use.
- Never place the product and accessories near naked flames or other heat sources, including direct sunlight.
- Never insert objects into the ventilation slots or other openings on the product.
- Where the mains plug or an appliance coupler is used as the disconnect device, the disconnect device shall remain readily operable.
- Disconnect the product from the power outlet before lightning storms.
- When you disconnect the power cord, always pull the plug, never the cable.

Risk of short circuit or fire!

- Before you connect the product to the power outlet, ensure that the power voltage matches the value printed on the back or bottom of the product. Never connect the product to the power outlet if the voltage is different.

Risk of injury or damage to the home theater!

- For wall-mountable products, use only the supplied wall mount bracket. Secure the wall mount to a wall that can support the combined weight of the product and the wall mount. Koninklijke Philips Electronics N.V. bears no responsibility for improper wall mounting that results in accident, injury or damage.

- For speakers with stands, use only the supplied stands. Secure the stands to the speakers tightly. Place the assembled stands on flat, level surfaces that can support the combined weight of the speaker and stand.
- Never place the product or any objects on power cords or on other electrical equipment.
- If the product is transported in temperatures below 5°C, unpack the product and wait until its temperature matches room temperature before connecting it to the power outlet.
- Visible and invisible laser radiation when open. Avoid exposure to beam.
- Do not touch the disc optical lens inside the disc compartment.

Risk of overheating!

- Never install this product in a confined space. Always leave a space of at least four inches around the product for ventilation. Ensure curtains or other objects never cover the ventilation slots on the product.

Risk of contamination!

- Do not mix batteries (old and new or carbon and alkaline, etc.).
- Remove batteries if they are exhausted or if the remote control is not to be used for a long time.
- Batteries contain chemical substances, they should be disposed of properly.

Product care

- Do not insert any objects other than discs into the disc compartment.
- Do not insert warped or cracked discs into the disc compartment.
- Remove discs from the disc compartment if you are not using the product for an extended period of time.
- Only use microfiber cloth to clean the product.

Disposal of your old product and batteries



Your product is designed and manufactured with high quality materials and components, which can be recycled and reused.



When this crossed-out wheeled bin symbol is attached to a product it means that the product is covered by the European Directive 2002/96/EC. Please inform yourself about the local separate collection system for electrical and electronic products.

Please act according to your local rules and do not dispose of your old products with your normal household waste.

Correct disposal of your old product helps to prevent potential negative consequences for the environment and human health.



Your product contains batteries covered by the European Directive 2006/66/EC, which cannot be disposed with normal household waste.

Please inform yourself about the local rules on separate collection of batteries because correct disposal helps to prevent negative consequences for the environmental and human health.

3D health warning

If you or your family has a history of epilepsy or photosensitive seizures, consult a medical professional before exposing yourself to flashing light sources, rapid image sequences or 3D viewing.

To avoid discomfort such as dizziness, headache or disorientation, we recommend not watching 3D for extended periods of time. If you experience any discomfort, stop watching 3D and do not immediately engage in any potentially hazardous activity (for example driving a car) until your symptoms have disappeared. If symptoms persist, do not resume watching 3D without consulting a medical professional first.

Parents should monitor their children during 3D viewing and ensure they do not experience any discomfort as mentioned above. Watching 3D is not recommended for children under six years of age as their visual system is not fully developed yet.

3 Your home theater

Congratulations on your purchase, and welcome to Philips! To fully benefit from the support that Philips offers, register your home theater at www.philips.com/welcome.

Main unit

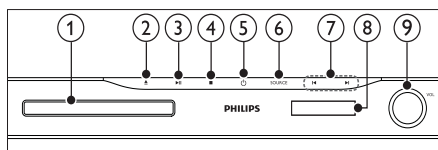

- ① **Disc compartment**
- ② **▲ (Open/Close)**
Opens or closes the disc compartment.
- ③ **▶|| (Play/Pause)**
Starts, pauses or resumes play.
- ④ **■ (Stop)**
 - Stops play.
 - In radio mode, erases the current preset radio station.
- ⑤ **⏻ (Standby-On)**
Switches the home theater on or to standby.
- ⑥ **SOURCE**
Selects an audio/video source for the home theater.
- ⑦ **⏮ / ⏭**
 - Skips to the previous or next track, chapter or file.
 - In radio mode, selects a preset radio station.
- ⑧ **Display panel**
- ⑨ **Volume control wheel**

Remote control

Note

- Your home theater is supplied with one of the following remote controls.

Remote control - A

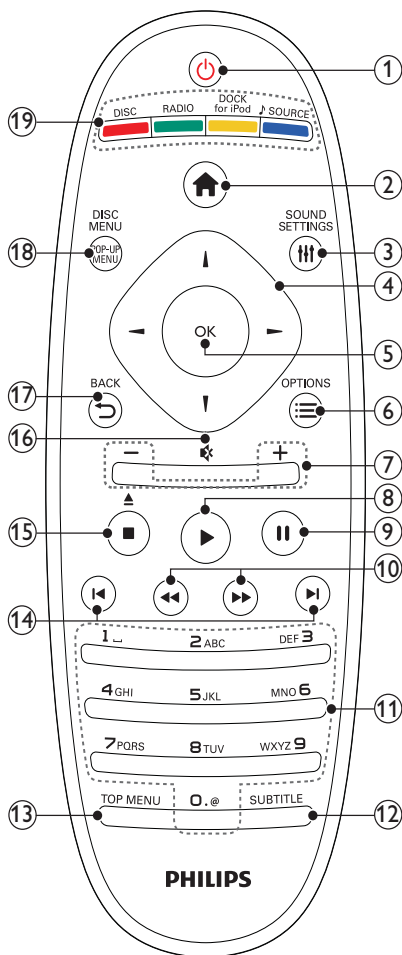

- ① **⏻ (Standby-On)**
- Switches the home theater on or to standby.
 - When EasyLink is enabled, press and hold for at least three seconds to switch all connected HDMI CEC compliant devices to standby.
- ② **🏠 (Home)**
Accesses the home menu.
- ③ **🔊SOUND SETTINGS**
Accesses or exits various sound options.
- ④ **Navigation buttons**
- Navigates menus.
 - In radio mode, press left or right to start auto search.
- ⑤ **OK**
- Confirms an entry or selection.
- ⑥ **☰OPTIONS**
- Accesses more play options during playback.
 - In radio mode, programs radio stations.
- ⑦ **+/- (Volume)**
Increases or decreases volume.
- ⑧ **▶ (Play)**
Starts or resumes play.
- ⑨ **⏸ (Pause)**
Pauses play.
- ⑩ **⏮ / ⏭ (Fast Backward/Fast Forward)**
Fast backwards or fast forwards. Press repeatedly to change the search speed.
- ⑪ **Alphanumeric buttons**
Enters values or letters (using SMS style entry).
- ⑫ **SUBTITLE**
Selects subtitle language for video.
- ⑬ **TOP MENU**
Accesses the main menu of a video disc.
- ⑭ **⏪ / ⏩ (Previous/Next)**
- Skips to the previous or next track, chapter or file.
 - In radio mode, selects a preset radio station.
- ⑮ **■ (Stop) / ▲ (Eject / Open/Close)**
- Stops play.
 - Press and hold to eject the disc or open the disc compartment.
 - In radio mode, erases the current preset radio station.
- ⑯ **🔇 (Mute)**
Mutes or restores volume.
- ⑰ **↶ BACK**
Returns to a previous menu screen.
- ⑱ **POP-UP MENU/DISC MENU**
Accesses or exits the disc menu.
- ⑲ **Source buttons**
- **Color buttons** (for Blu-ray discs): Selects tasks or options.
 - **DISC**: Switches to disc source.
 - **RADIO**: Switches to FM radio.
 - **DOCK for iPod**: Switches to Philips Dock for iPod/iPhone.
 - **JSOURCE**: Selects an audio input source.

Remote control - B

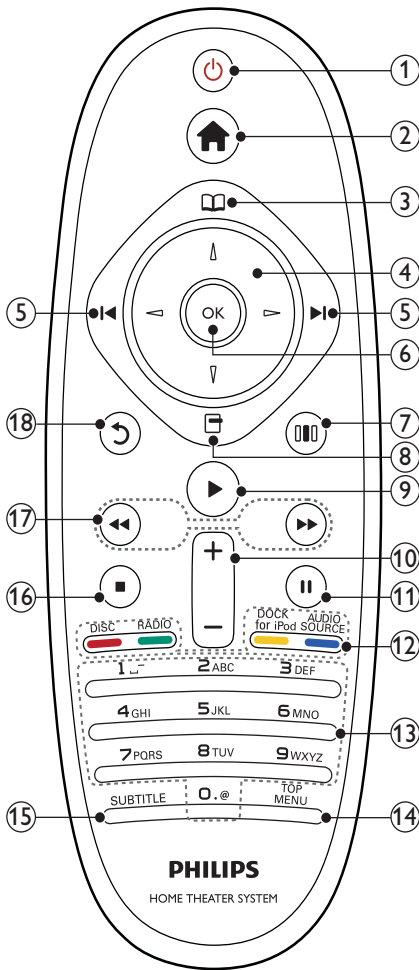

- ① **⏻ (Standby-On)**
 - Switches the home theater on or to standby.
 - When EasyLink is enabled, press and hold for at least three seconds to switch all connected HDMI CEC compliant devices to standby.
- ② **🏠 (Home)**
Accesses the home menu.
- ③ **📖 (Disc menu)**
Accesses or exits the disc menu.
- ④ **Navigation buttons**
 - Navigates menus.
 - In radio mode, press left or right to start auto search.
- ⑤ **⏮ / ⏭ (Previous/Next)**
 - Skips to the previous or next track, chapter or file.
 - In radio mode, selects a preset radio station.
- ⑥ **OK**
Confirms an entry or selection.
- ⑦ **🔊 (Sound options)**
Accesses or exits various sound options.
- ⑧ **⏹ (Options)**
 - Accesses more play options during playback.
 - In radio mode, programs radio stations.
- ⑨ **▶ (Play)**
Starts or resumes play.
- ⑩ **+/- (Volume)**
Increases or decreases volume.
- ⑪ **⏸ (Pause)**
Pauses play.
- ⑫ **Source buttons / Color buttons**
 - Blu-ray discs: Selects tasks or options.
 - **AUDIO SOURCE:** Selects an audio input source.
 - **DOCK for iPod:** Switches to Philips Dock for iPod/iPhone.
 - **RADIO:** Switches to FM radio.
 - **DISC:** Switches to disc source.
- ⑬ **Alphanumeric buttons**
Enters values or letters (using SMS style entry).

- ⑭ **TOP MENU**
Accesses the main menu of a video disc.
- ⑮ **SUBTITLE**
Selects subtitle language for video.
- ⑯ **■ (Stop)**
- Stops play.
 - Press and hold to eject the disc or open the disc compartment.
 - In radio mode, erases the current preset radio station.
- ⑰ **◀◀ / ▶▶ (Fast Backward/Fast Forward)**
Fast backwards or fast forwards. Press repeatedly to change the search speed.
- ⑱ **↶ (Back)**
Returns to a previous menu screen.

4 Connect your home theater

This section helps you connect your home theater to a TV and other devices. The basic connections of the home theater with its accessories are provided in the Quick Start. For a comprehensive interactive guide, see www.connectivityguide.philips.com.

≡ Note

- Refer to the type plate at the back or bottom of the product for identification and supply ratings.
- Before you make or change any connections, ensure that all devices are disconnected from the power outlet.

Connectors

Connect other devices to your home theater:

Front connectors



- ① **MP3 LINK**
Audio input from an MP3 player.
- ② **••• (USB)**
Audio, video or picture input from a USB storage device.

Back connectors

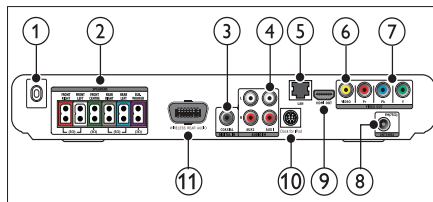

- ① **AC MAINS~**
Connects to the power supply.
- ② **SPEAKERS**
Connects to the supplied speakers and subwoofer.
- ③ **DIGITAL IN-COAXIAL**
Connects to the coaxial audio output on the TV or a digital device.
- ④ **AUDIO IN-AUX 1/AUX 2**
Connects to the analog audio output on the TV or an analog device.
- ⑤ **LAN**
Connects to the LAN input on a broadband modem or router.
- ⑥ **VIDEO OUT-VIDEO**
Connects to the composite video input on the TV.
- ⑦ **VIDEO OUT-Y Pb Pr**
Connects to the component video input on the TV.
- ⑧ **FM ANTENNA**
Connects the FM antenna for radio reception.
- ⑨ **HDMI OUT (ARC)**
Connects to the HDMI input on the TV.
- ⑩ **DOCK for iPod**
Connects to a Philips Dock for iPod/iPhone. (Model: Philips DCK3060)
- ⑪ **Wireless Rear Audio**
Connects to the wireless transmitter (PHILIPS RWSS5510).

Connect to the TV

Connect your home theater directly to a TV through one of the following connectors (from highest to basic quality video):

- ① **HDMI**
- ② **Component video**
- ③ **Composite video**

Option 1: Connect to the TV through HDMI

Note

- The HDMI connector on the TV might be labeled **HDMI IN** or **HDMI ARC**.
- If the TV supports HDMI Audio Return Channel (ARC), you can use it to output digital audio to the home theater.
- If the HDTV has a DVI connector, connect using an HDMI/DVI adapter.
- If the TV supports EasyLink HDMI CEC, control the home theater and TV with one remote control (see 'Use Philips EasyLink' on page 19).

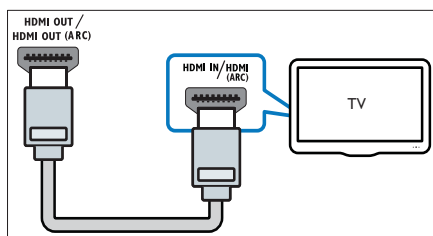

Option 2: Connect to the TV through YPbPr (component video)

Note

- The component video cable or connector might be labeled **Y Cb Cr** or **YUV**.

(Cable not supplied)

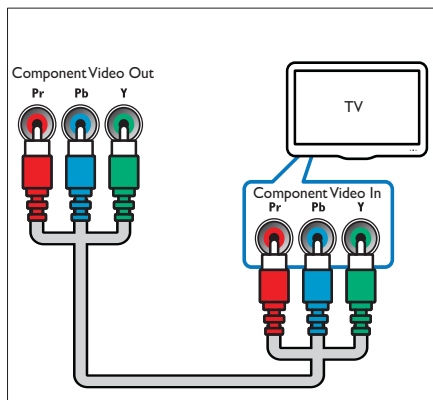

Option 3: Connect to the TV through composite video (CVBS)

Note

- The composite video cable or connector might be labeled **AV IN**, **VIDEO IN**, **COMPOSITE** or **BASEBAND**.

(Cable not supplied)

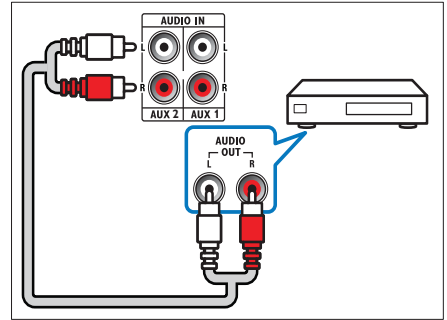
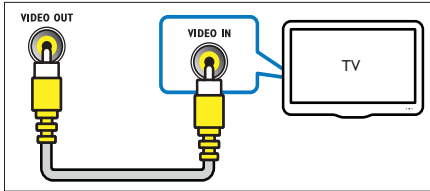

Option 2: Connect audio through coaxial cable

Note

- The digital coaxial cable or connector might be labeled **COAXIAL/DIGITAL OUT** or **SPDIF OUT**.

(Cable not supplied)

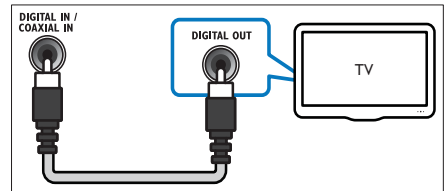

Connect audio from TV or other devices

Use your home theater to play audio from the TV or other devices such as a cable box.

Tip

- Press **SOURCE / AUDIO SOURCE** repeatedly to select the audio output of your connection.

Option 1: Connect audio through analog audio cables

(Cable not supplied)

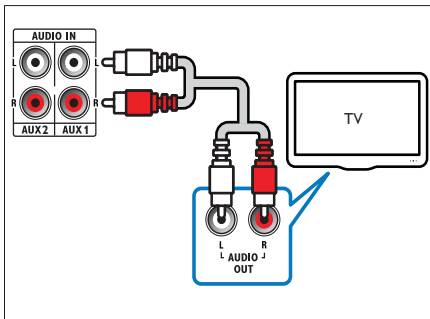

Connect a wireless module

Note

- If you connect the supplied wireless transmitter to the home theater, you need to connect the rear left and rear right speakers to the matching connectors at the bottom/rear of the wireless receiver.
- When you connect and switch on the wireless module, the rear speaker connectors on the home theater are muted, the rear surround sound is output through the connectors on the wireless receiver.

(Model: PHILIPS RWSS5510 - supplied)

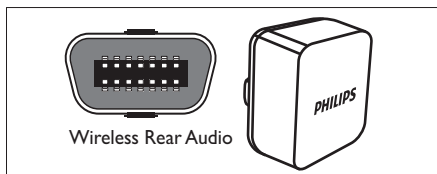

Connect to a computer network and the Internet

Connect the home theater to a computer network and enjoy:

- **Multimedia content streamed from your computer** : view photos, play music and watch video files streamed from your computer (see 'Play from PC (DLNA)' on page 17).
- **BD-Live applications** : access to some exclusive services from the BD-Live enabled Blu-ray discs (see 'Access BD-Live on Blu-ray' on page 15).
- **Software update** : update the software of the home theater through the network (see 'Update software from the network' on page 23).

What you need:

- A network router (with DHCP enabled).
- A network cable (RJ45 straight cable).
- A computer with media server software installed (see 'Set up media server software' on page 17).
- For BD-Live application and software update, make sure that the network router has access to the Internet and the firewall is disabled.

(Cable not supplied)

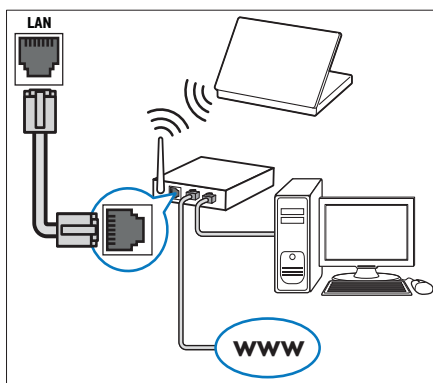

Set up network

- 1 Connect the home theater to a broadband modem or router (see 'Connect to a computer network and the Internet' on page 12).
- 2 Turn on your TV and switch to the correct source for the home theater.
- 3 Press **Home**.
- 4 Select **[Setup]**, then press **OK**.
- 5 Select **[Network] > [Network Installation]**, then press **OK**.
- 6 Select **[Wired (Ethernet)]**, then press **OK**.
- 7 Select **[Auto (recommended)]** or **[Manual (advanced)]**, then press **OK**.
- 8 Follow the instructions on the TV to complete the setup.
 - ↳ The home theater connects to the internet. If connection fails, select **[Retry]**, then press **OK**.
- 9 Select **[Finish]**, then press **OK** to exit.



Caution

- Familiarize yourself with the network router, media server software and networking principles before attempting to connect the home theater to a computer network. If necessary, read documentation accompanying network components. Philips is not responsible for lost, damaged or corrupt data.

5 Use your home theater

This section helps you use the home theater to play media from a wide range of sources.

Before you start

Check that you:

- Make the necessary connections and complete the setup as described in the Quick Start.
- Switch the TV to the correct source for the home theater.

Access the home menu

The home menu gives you easy access to connected devices, audio and video settings, and other features.

- 1 Press **Home**.
↳ The home menu appears.
- 2 Press the **Navigation buttons** and **OK** to select the following:
 - **[play Disc]** : Starts disc play.
 - **[browse USB]** : Accesses the content browser of the connected USB storage device.
 - **[browse iPod]** : Accesses the content browser of the connected iPod or iPhone.
 - **[browse PC]** : Accesses the content browser of the connected PC network.
 - **[Setup]** : Accesses menus to change picture, sound and other settings.

Choose your sound

This section helps you choose the ideal sound for your video or music.

- 1 Press **SOUND SETTINGS / [Sound options]**.
- 2 Press the **Navigation buttons** (left/right) to access the sound options.

Sound experience	Description
AUTO VOLUME	Sets a constant output signal at the speaker output. This option is best for TV audio input where the commercial signal level is usually higher than the content.
SOUND	Selects a sound mode.
SURROUND	Selects a surround sound or stereo sound.
TREBLE	Adjusts the high frequency output.
MID	Adjusts the middle frequency output.
BASS	Adjusts the low frequency output.
AUDIO SYNC	Delays the audio to match the video.

- 3 Select an option, then press **OK**.
- 4 Press **BACK** to exit.

If you do not press a button within five seconds, it automatically exits the menu.

Change auto volume

Select the level of volume which output from your TV or other devices to the home theater.

- 1 Press **SOUND SETTINGS / [Sound options]**.
- 2 Select **AUTO VOLUME**, then press **OK**.
- 3 Press the **Navigation buttons** (up/down) to select **ON** or **OFF**.
- 4 Press **OK** to confirm your choice.

Change sound mode

Select predefined sound modes to suit your video or music.

- 1 Press **SOUND SETTINGS / [Sound options]**.
- 2 Select **SOUND**, then press **OK**.
- 3 Press the **Navigation buttons** (up/down) to select the following settings:
 - **ACTION/ROCK** : Enhanced low and high-range. Ideal for action movies and rock or pop music.

- **DRAMA/JAZZ** : Clear mid and high-range. Ideal for drama movies and jazz music.
- **CONCERT/CLASSIC**: Neutral sound. Ideal for live concerts and classical music.
- **SPORTS** : Moderate mid-range and surround effects for clear vocals and the atmosphere of a live sport venue.

4 Press **OK** to confirm your choice.

Change surround sound mode

Experience an immersive audio experience with surround sound modes.

- 1 Press **SOUND SETTINGS / [] (Sound options)**.
- 2 Select **SURROUND**, then press **OK**.
- 3 Press the **Navigation buttons** (up/down) to select the following settings:
 - **5CH STEREO** : Enhances the stereo channel output by duplicating the sound output to the center and rear speakers. Ideal for party music.
 - **MULTI-CHANNEL/Dolby PLII** : Immersive multi-channel sound for an enhanced movie experience.
 - **STEREO** : Two-channel stereo sound. Ideal for listening to music.

4 Press **OK** to confirm your choice.

Change treble, mid and bass

Change the high frequency (treble), mid frequency (mid) and low frequency (bass) settings of the home theater to suit your video or music.

- 1 Press **SOUND SETTINGS / [] (Sound options)**.
- 2 Select **TREBLE, MID** or **BASS**, then press **OK**.
- 3 Press the **Navigation buttons** (up/down) to adjust the frequency level.
- 4 Press **OK** to confirm.

Synchronize audio with video

If the audio and video are not synchronized, you can delay the audio to match the video.

- 1 Press **SOUND SETTINGS / [] (Sound options)**.
- 2 Select **AUDIO SYNC**, then press **OK**.
- 3 Press the **Navigation buttons** (up/down) to sync the audio with the video.
- 4 Press **OK** to confirm.

Play a disc

The home theater can play a wide variety of discs, including video, audio and mixed media (for example, a CD-R that contains JPEG pictures and MP3 music).

- 1 Insert a disc into the home theater.
- 2 Press **DISC**, or select **[play Disc]** in the home menu and press **OK**.
 - ↳ The disc plays or the disc main menu appears.
- 3 Press the following buttons to control play:

Button	Action
Navigation buttons	Navigate menus.
OK	Confirms an entry or selection.
▶(Play)	Starts or resumes play.
 	Pauses play.
■	Stops play.
◀ / ▶	Skips to the previous or next track, chapter or file.
◀◀ / ▶▶	Fast backwards or fast forwards. Press repeatedly to change the search speed.
Navigation buttons (up/down)	Rotates the picture counter-clockwise or clockwise.
SUBTITLE	Selects subtitle language for video.
POP-UP MENU / DISC MENU / [] (Disc menu)	Accesses or exits the disc menu.
☰OPTIONS / [] (Options)	Accesses more play options during playback.

For video formats such as, DivX and WMV:

- To stop play, press **■**.
- To resume the video from where you stopped, press **▶ (Play)**.
- To play the video from the start, press **OK**.

Note

- To play DivX DRM - protected files from a disc or a USB storage device, connect your home theater to a TV through an HDMI cable.

Use Bonus View on Blu-ray

Blu-ray discs that support the Bonus View feature (also known as Picture-In-Picture) allow you to view special content such as a director's commentary while watching the main feature.

- 1 If necessary, enable BonusView (or Picture-In-Picture) in the Blu-ray disc menu.
- 2 During playback of the main feature, press **≡OPTIONS / □ (Options)**.
↳ The options menu is displayed.
- 3 Select **[PIP Selection] > [PIP]**, then press **OK**.
↳ PIP options [1]/[2] depend on the video contents.
↳ The picture-in-picture video appears in a small window.
- 4 Select **[2nd Audio Language]** or **[2nd Subtitle Language]**, then press **OK**.
- 5 Select the language to play, then press **OK**.

Note

- To turn off the Bonus View (Picture-in-Picture), press **≡OPTIONS / □ (Options)**, select **[PIP Selection] > [Off]**, then press **OK**.

Access BD-Live on Blu-ray

BD-Live enabled Blu-ray discs include exclusive services such as movies and other online bonuses.

- 1 Prepare the internet connection and set up the network (see 'Connect to a computer network and the Internet' on page 12).

- 2 Connect the USB storage device to the home theater.
- 3 Select the BD-Live icon in the disc menu, then press **OK**.
↳ BD-Live starts to load. The loading time depends on the disc and your internet connection.
- 4 Press the **Navigation buttons** to navigate BD-Live.
- 5 Press **OK** to select an item.

Note

- The range of BD-Live services depends on the disc.
- When you use BD-Live, data on the disc and home theater are accessed by the content provider.
- Use a USB storage device with at least 1GB of free space to store the downloaded files.
- If there is insufficient memory to download BD-Live content, clear memory space.

Play 3D video

Your home theater can play 3D videos on 3D TVs.

Before you start, make sure that:

- your TV is a 3D TV, and is connected to your home theater through HDMI,
- your disc is a Blu-ray 3D disc, and
- you have 3D glasses that are compatible with your 3D TV.

- 1 Insert a Blu-ray 3D disc into your home theater.
↳ Your TV switches to the correct HDMI source, and the disc plays automatically.
- 2 If the disc does not play automatically, press **DISC** or select **[play Disc]** in the home menu, and then press **OK**.
- 3 Press the play buttons to control play. When you search forward or backward, and in some other play modes, the video displays in 2D. It returns to 3D when you play normally again.
- 4 Put on the 3D glasses to enjoy the 3D effects.

Play 3D discs in 2D

- 1 Press **⬆** (Home).
- 2 Select **[Setup] > [Video] > [Blu-ray 3D video] > [Off]**.
- 3 Press **OK**.
- 4 Play your Blu-ray 3D disc.
↳ The 3D video is displayed in 2D.

Play from a USB storage device

The home theater is fitted with a USB connector that allows you to view pictures, listen to music or watch movies stored on a USB storage device.

- 1 Connect the USB storage device to the home theater.
- 2 Press **⬆** (Home).
↳ The home menu appears.
- 3 Select **[browse USB]**, then press **OK**.
↳ A content browser appears.
- 4 Select a file, then press **OK**.
- 5 Press the playback buttons to control play (see 'Play a disc' on page 14).



Note

- If the USB storage device does not fit into the connector, use a USB extension cable.
- The home theater does not support digital cameras that need a computer program to display photos.
- The USB storage device must be NTFS, FAT or DOS-formatted, and Mass Storage Class compliant.

More play features for disc or USB

Several advanced features are available for video or picture playback from a disc or USB storage device.

Use video options

Access several useful features while viewing video.



Note

- Available video options depend on the video source.

- 1 Press **≡** **OPTIONS** / **⌘** (**Options**).
↳ The video options menu appears.
- 2 Press the **Navigation buttons** and **OK** to select and adjust:
 - **[Audio Language]** : Selects audio language for video.
 - **[Subtitle Language]** : Selects subtitle language for video.
 - **[Subtitle Shift]** : Adjusts the subtitle position on the screen.
 - **[Info]** : Displays information about what is playing.
 - **[Character Set]** : Selects a character set that supports the DivX subtitle.
 - **[Time Search]** : Skips to a specific part of the video by entering the time of the scene.
 - **[2nd Audio Language]** : Selects the second audio language to play.
 - **[2nd Subtitle Language]** : Selects the second subtitle language to play.
 - **[Titles]** : Selects a specific title.
 - **[Chapters]** : Selects a specific chapter.
 - **[Angle List]** : Selects a different camera angle.
 - **[Menus]** : Displays the disc menu.
 - **[PIP Selection]** : Displays Picture-in-Picture window.
 - **[Zoom]** : Zooms into a video scene or picture. Press the **Navigation buttons** (left/right) to select a zoom factor.
 - **[Repeat]** : Repeats a chapter or title.
 - **[Repeat A-B]** : Marks two points within a chapter or track for repeat play, or turns off repeat mode.
 - **[Picture Settings]** : Selects a predefined color setting.

Use picture options

Access several useful features while viewing pictures.

- 1 Press **≡** **OPTIONS** / **⏏** (**Options**).
↳ The pictures options menu appears.
- 2 Press the **Navigation buttons** and **OK** to select and adjust:
 - **[Rotate +90]** : Rotates the picture 90 degree clockwise.
 - **[Rotate -90]** : Rotates the picture 90 degree counter-clockwise.
 - **[Zoom]** : Zooms into a video scene or picture. Press the **Navigation buttons** (left/right) to select a zoom factor.
 - **[Info]** : Displays picture information.
 - **[Duration per slide]** : Sets the display speed for each picture in a slide show.
 - **[Slide Animation]** : Selects animation for the slide show.
 - **[Picture Settings]** : Selects a predefined color setting.
 - **[Repeat]** : Repeats a selected folder.

Use audio options

Access several useful features while audio is played.

- 1 Press **≡** **OPTIONS** / **⏏** (**Options**) repeatedly to cycle through the following functions:
 - **REPEAT TRACK** : Repeats the current track.
 - **REPEAT DISC** : Repeats all the tracks on the disc or folder.
 - **REPEAT RANDOM** : Plays audio tracks in random order.
 - **REPEAT OFF** : Turns off repeat mode.

Play a musical slideshow

Play music and pictures simultaneously to create a musical slideshow.

- 1 Select a music track, then press **OK**.
- 2 Press **↩** **BACK** and go to the picture folder.
- 3 Select a picture, then press **OK** to start slideshow.

- 4 Press **■** to stop slideshow.
- 5 Press **■** again to stop music.

Play from PC (DLNA)

(For HTS5580W and HTS5590W only)

When you connect your home theater to your home network, you can play music, photo, and video from a computer or other media server on that network.

What you need:

- A wired or wireless home network, connected with a Universal Plug and Play (uPnP) router.
- A Philips wireless USB adapter or a LAN able to connect your home theater to your home network.
- A media server such as:
 - PC running Windows Media Player 11 or higher; or
 - Mac running Twonky Media Server.

For help to use other media servers, such as TVersity, see the web site of the media server.

Set up media server software

Before you start:

- Connect your home theater to your home network (see 'Connect to a computer network and the Internet' on page 12).
- Connect your PC to the same home network.
- Make sure that your PC firewall allows you to run Windows Media Player programs.

In Microsoft Windows Media Player 11

- 1 Connect the home theater to a network router (see 'Connect to a computer network and the Internet' on page 12).
- 2 Switch on the computer and router.
- 3 Open Windows Media Player on the computer.
- 4 Select **Library** > **Media Sharing**, then select settings to share your media.

5 Select **Library > Add to Library**, then select settings to share the folder containing your media.

6 Select **Advanced options**, then add the folders to share.

7 Select **Library > Apply Media Information Changes** to activate the changes.

In Macintosh OS X Twonky Media (v4.4.2)

1 Connect the home theater to a network router (see 'Connect to a computer network and the Internet' on page 12).

2 Switch on the Macintosh and router.

3 Visit www.twonkymedia.com to purchase the software or download a free 30-day trial to your Macintosh.

4 Open Twonky Media on the Macintosh.

↳ The media sharing setting is turned on by default, thus enabling you to directly add folders for media sharing.

5 Select **Basic Setup > Sharing**, then select settings to add a folder location or add more folders.

6 Select **Save Changes** to activate the changes.

Play multimedia content

(For HTS5580W and HTS5590W only.)

Note

- Before playing multimedia content from the computer, ensure that the home theater is connected to the computer network and the media server software is properly set up.

1 Press **⬆** (**Home**).

↳ The home menu appears.

2 Select [**browse PC**], then press **OK**.

↳ A content browser appears.

3 Select a file, then press **OK**.

4 Press the playback buttons to control play (see 'Play a disc' on page 14).

Play from radio





The home theater can store up to 40 radio stations.

1 Check that the FM antenna is connected.

2 Press **RADIO**.

↳ "AUTO INSTALL...PRESS PLAY" appears on the display panel if you have not installed any radio stations. Press **▶** (**Play**).

3 Press the following buttons to control play:

Button	Action
	Selects a preset radio station.
Navigation buttons (left/right)	Searches for a radio station.
Navigation buttons (up/down)	Fine tunes a radio frequency.
	Press and hold to erase the preset radio station. Press to stop the installation of radio stations.
 OPTIONS /  (Options)	Manual: Press once to access program mode, and press again to store the radio station. Automatic: Press and hold for five seconds to reinstall radio stations.
RADIO	Toggles between stereo and mono sound.

Note

- AM and digital radio are not supported.
- If no stereo signal is detected, you are prompted to install the radio stations again.
- For the best reception, place the antenna away from the TV or other sources of radiation.

Change tuning grid

In some countries, you can switch the FM tuning grid between 50 kHz and 100 kHz. Changing the tuning grid erases all preset radio stations.

1 Press **RADIO**.

2 Press **■** (**Stop**).

3 Press and hold **▶** (**Play**) to toggle between 100 kHz and 50 kHz frequency.

Play audio from TV or other devices

Press **J**SOURCE / AUDIO SOURCE repeatedly to select the audio output of the connected device.

Play from an MP3 player

Connect and play audio files from an MP3 player or other external audio devices.

- 1 Connect the MP3 player to the home theater as described in the Quick start guide.
- 2 Press **J**SOURCE / AUDIO SOURCE repeatedly until 'MP3 LINK' appears on the display panel.
- 3 Press the buttons on the MP3 player to select and play audio files.

Play from an iPod or iPhone

By connecting and installing a Philips Dock for iPod/iPhone, you can use the home theater to play music, movies and photos from your iPod or iPhone.

Note

- Philips Dock for iPod/iPhone is sold separately.
- You can charge your iPod/iPhone on the dock while the home theater is in iPod mode.

Dock your iPod or iPhone

- 1 Connect the dock to the home theater and connect the yellow composite cable from the dock to the TV. For more information, see the Quick Start provided with the dock.
- 2 Switch on the iPod or iPhone and place it in the dock.
- 3 On the home theater remote control, press **⬆** (Home), then select [**browse iPod**] and press **OK**.

Listen to music

- 1 Dock your iPod or iPhone (see 'Dock your iPod or iPhone' on page 19).
- 2 Press **DOCK for iPod** on the home theater remote control.
 - ↳ The playlists are displayed on the TV.
- 3 Press the **Navigation buttons** and **OK** to select and play tracks.

Watch video or view slideshows

Note

- On iPod, enable the TV ON setting.
- On iPhone, select the TV Out option.

- 1 Dock your iPod or iPhone (see 'Dock your iPod or iPhone' on page 19).
- 2 Switch the TV to the **AV/VIDEO** source (corresponding to the yellow composite cable).
 - ↳ The TV screen goes blank.
- 3 Browse on the iPod or iPhone screen to select videos or photos.
- 4 Press **▶** (Play) to play the video and photos.
 - ↳ The picture is displayed on the TV.

Use Philips EasyLink

The home theater supports Philips EasyLink, which uses the HDMI CEC (Consumer Electronics Control) protocol. EasyLink-compliant devices that are connected through HDMI connectors can be controlled by a single remote control.

Note

- Philips does not guarantee 100% interoperability with all HDMI CEC devices.

- 1 Switch on the HDMI CEC operations on the TV and other connected devices. See the manual of the TV or other devices for details.
- 2 Press **⬆** (Home).
- 3 Select [**Setup**], then press **OK**.

- 4 Select **[EasyLink]** > **[EasyLink]**, then press **OK**.
- 5 Select **[On]**, then press **OK**.
- 6 You can now enjoy the following Philips EasyLink controls.

One-touch play

When you play a disc, the TV automatically switches to the correct channel.

One-touch standby

When you press and hold **⏻ (Standby)** on the remote control, the home theater and all the connected HDMI CEC devices (if they support one-touch standby) switch to standby mode simultaneously.

System Audio Control

When you play a device that has its audio output routed to the home theater, the home theater switches to the corresponding audio source automatically.

To use one-touch audio, enable this feature and follow the instructions on the TV to map the connected devices correctly to the audio input jacks of the home theater.

Audio Input Mapping

Updates audio input mapping if there are new devices connected.

6 Change settings

This section helps you to change the settings of your home theater.



Caution

- Most of the settings are already configured with the best value for the home theater. Unless you have a specific reason to change a setting, it is best to leave it at the default value.

Access the setup menu

- 1 Press **⬆️ (Home)**.
- 2 Select **[Setup]**, then press **OK**.
↳ The setup menu appears.
- 3 Select a setup menu, then press **OK**.
See the following sections for information about how to change the settings of your home theater.
- 4 Press **⬅️ BACK** to return to the previous menu, or press **⬆️** to exit.



Note

- You cannot change a setting that is grayed out.

Change video settings

- 1 Press **⬆️ (Home)**.
- 2 Select **[Setup]**, then press **OK**.
- 3 Select **[Video]**, then press **OK**.
- 4 Select and adjust the following settings:
 - **[TV Display]**: Selects a picture display format to fit the TV screen.
 - **[HDMI Video]**: Selects the HDMI video resolution.
 - **[HDMI Deep Color]**: Displays colors with more shades and hues when the video content is recorded in Deep Color and the TV supports this feature.

- **[Component Video]**: Selects the component video resolution. Copy-protected DVDs can display only 480p/576p or 480i/576i.
- **[Blu-ray 3D video]**: Selects the 3-dimensional video output when you play a 3D video on your home theater. The home theater must be connected to a 3D TV through HDMI.
- **[Picture Settings]**: Selects a predefined color setting.

5 Press **OK** to confirm your choice.

Note

- The best setting is automatically selected for the TV. If you change the setting, ensure that the TV supports the new setting.
- For settings related to HDMI, the TV must be connected through HDMI.
- For settings related to progressive or component video, the TV must be connected through Component Video.

Change audio settings

- 1 Press **▲** (Home).
- 2 Select **[Setup]**, then press **OK**.
- 3 Select **[Audio]**, then press **OK**.
- 4 Select and adjust the following settings:
 - **[Night Mode]**: Selects quiet or full dynamic sound. Night mode decreases the volume of loud sounds and increases the volume of soft sounds such as speech.
 - **[HDMI Audio]**: Selects HDMI audio format or disables HDMI audio output for the TV.
 - **[Speaker Setup]**: Sets the volume level and distance of each speaker to obtain the best possible surround sound based on your room setup.
- 5 Press **OK** to confirm your choice.

Note

- For settings related to HDMI, the TV must be connected through HDMI.
- Night mode is available for Dolby encoded DVD and Blu-ray discs (for models support Blu-ray playback).

Set up network

- 1 Press **▲** (Home).
- 2 Select **[Setup]**, then press **OK**.
- 3 Select **[Network]**, then press **OK**.
- 4 Select and adjust the following settings:
 - **[Network Installation]**: Starts wired (Ethernet) setup. Follow the instructions to set up the network connection.
 - **[View Network Settings]**: Displays the current network settings.
- 5 Press **OK** to confirm your choice.

Set up EasyLink

- 1 Press **▲** (Home).
- 2 Select **[Setup]**, then press **OK**.
- 3 Select **[EasyLink]**, then press **OK**.
- 4 Select and adjust the following settings:
 - **[EasyLink]**: Enables or disables EasyLink.
 - **[One Touch Play]**: Enables or disables One Touch Play.
If enabled, you can use the remote control to start disc play in the home theater and the TV switches automatically to the correct channel.
 - **[One Touch Standby]**: Enables or disables One Touch Standby.
If enabled, the home theater can be switched off to standby by a remote control from the TV or other connected HDMI CEC devices.

- **[System Audio Control]** : Enables or disables System audio control.
If enabled, follow the instructions on the TV to map the connected devices correctly to the audio connectors of the home theater. The home theater switches automatically to the audio source of the connected device.
- **[Audio Input Mapping]** : Updates audio input mapping if there are new devices connected.

5 Press **OK** to confirm your choice.

Note

- The connected devices must be connected through HDMI and switched on.

Change preference settings

- 1 Press **▲** (**Home**).
- 2 Select **[Setup]**, then press **OK**.
- 3 Select **[Preference]**, then press **OK**.
- 4 Select and adjust the following settings:
 - **[Menu language]** : Selects the on-screen display menu language.
 - **[Audio]** : Selects audio language for video.
 - **[Subtitle]** : Selects subtitle language for video.
 - **[Disc Menu]** : Selects menu language for video disc.
 - **[Parental Control]** : Restricts access to discs that are recorded with ratings. To play all discs irrespective of the rating, select level '8'.
 - **[Screen Saver]** : Enables or disables screen saver mode. If enabled, the screen enters idle mode after 10 minutes of inactivity (for example, in pause or stop mode).
 - **[Auto Subtitle Shift]** : Enables or disables shift subtitle. If enabled, it adjusts the subtitle position automatically to fit the TV screen.

- **[Change Password]** : Sets or changes a PIN code to play a restricted disc. Enter '0000' if you do not have a PIN or if you have forgotten your PIN.
- **[Display Panel]** : Changes the brightness of the display panel.
- **[Auto Standby]** : Enables or disables auto standby. If enabled, the home theater switches to standby after 30 minutes of inactivity (for example, in pause or stop mode).
- **[VCD PBC]** : Displays or skips the content menu for VCD and SVCD discs.
- **[Sleep Timer]** : Sets a sleep timer to switch the home theater to standby after a specific time.

5 Press **OK** to confirm your choice.

Note

- If your preferred disc language is not available, you can select **[Other]** from the list and enter the 4-digit language code which can be found at the back of this manual.
- If you select a language that is not available on a disc, the home theater uses the default language of the disc.

Change advanced settings

- 1 Press **▲** (**Home**).
- 2 Select **[Setup]**, then press **OK**.
- 3 Select **[Advanced]**, then press **OK**.
- 4 Select and adjust the following settings:
 - **[BD-Live Security]** : Restricts or allows access to BD-Live.
 - **[Enhanced Audio]** : Enables or disables the audio post processing at the speaker output.
 - **[Software Update]** : Selects to update software from the network or from USB storage device.
 - **[Clear memory]** : Clears local memory, delete the BD-Live files that you previously downloaded. If using an USB storage device, the local storage folder is 'BUDA'.

- **[DivX® VOD Code]** : Displays the DivX VOD registration code for the home theater.
- **[Version Info.]** : Displays the software version for the home theater.
- **[Restore default settings]** : Resets the home theater to the default settings programmed at the factory.

5 Press **OK** to confirm your choice.

Note

- You cannot restrict internet access on commercial Blu-ray discs.
- Before you purchase DivX videos and play them on the home theater, register the home theater on www.divx.com using the DivX VOD code.
- You cannot reset parental control setting to its default value.

7 Update software

To check for new updates, compare the current software version of your home theater with the latest software version (if available) on the Philips web site.

Check software version

- 1** Press **⬆** (**Home**).
- 2** Select **[Setup]**, then press **OK**.
- 3** Select **[Advanced]** > **[Version Info.]**, then press **OK**.
 - ↳ The software version is displayed.

Update software from the network

- 1** Prepare the internet connection (see 'Connect to a computer network and the Internet' on page 12).
- 2** Press **⬆** (**Home**) and select **[Setup]**.
- 3** Select **[Advanced]** > **[Software Update]** > **[Network]**.
 - ↳ If an upgrade media is detected, you are prompted to start or cancel the update.
- 4** Follow the instruction on the TV to confirm the update.
 - ↳ When complete, the home theater automatically switches off and restarts.
 - If not, disconnect the power cord for a few seconds and then reconnect it.

Note

- If the home theater is unable to connect to the Philips server, press **⬆** (**Home**), select **[Setup]** > **[Network]** > **[Network Installation]** to set up the network.

Update software from a USB

- 1 Check for the latest software version on www.philips.com/support.
 - Search for your model and click on 'software and drivers'.
- 2 Create a folder named 'UPG' in the root directory of your USB storage device.
- 3 Download the software into the 'UPG' folder of the USB storage device.
- 4 Unzip the software in the 'UPG' folder.
- 5 Connect the USB storage device to the home theater.
- 6 Press **Home** and select **[Setup]**.
- 7 Select **[Advanced]** > **[Software Update]** > **[USB]**.
- 8 Follow the instructions on the TV to confirm the update.
 - ↳ When complete, the home theater automatically switches off and restarts.
 - If not, disconnect the power cord for a few seconds and then reconnect it.



Caution

- Do not turn off the power or remove the USB storage device when the software update is in progress because you might damage the home theater.

8 Product specifications



Note

- Specification and design are subject to change without notice.

Region code

The type plate on the back or bottom of the home theater shows which regions it supports

Country	DVD	BD
Europe, United Kingdom		
Asia Pacific, Taiwan, Korea		
Latin America		
Australia, New Zealand		
Russia, India		
China		

Playback media

- AVCHD, BD-RE, BD-Video, DVD-Video, DVD+R/+RW, DVD-R/-RW, DVD+R/-R DL, CD-R/CD-RW, Audio CD, Video CD/ SVCD, Picture CD, MP3-CD, WMA-CD, DivX (Ultra)-CD, USB storage device

File Format

- Audio: .mp3, .wma, .wav
- Video: .avi, .divx, .mp4, .mkv, .mov, .wmv
- Picture: .jpg, .gif, .png

Amplifier

- Total output power: 1000W RMS (30% THD)
- Frequency response: 20 Hz-20 kHz / ±3dB
- Signal-to-noise ratio: > 65 dB (CCIR) / (A-weighted)
- Input sensitivity:
 - AUX: 500 mV
 - MP3 LINK: 300 mV

Video

- Signal system: PAL / NTSC
- Component video output: 480i/576i, 480p/576p, 720p, 1080i
- HDMI output: 480i/576i, 480p/576p, 720p, 1080i, 1080p, 1080p24

Audio

- S/PDIF Digital audio input:
 - Coaxial: IEC 60958-3
- Sampling frequency:
 - MP3: 32 kHz, 44.1 kHz, 48 kHz
 - WMA: 44.1 kHz, 48 kHz
- Constant bit rate:
 - MP3: 112 kbps - 320 kbps
 - WMA: 48 kbps - 192 kbps

Radio

- Tuning range: FM 87.5-108 MHz (50/100 kHz)
- Signal-to-noise ratio: FM 50 dB
- Frequency response: FM 180 Hz-12.5 kHz / ± 3 dB

USB

- Compatibility: Hi-Speed USB (2.0)
- Class support: UMS (USB Mass Storage Class)
- File system: NTFS, FAT16, FAT32
- Maximum memory support: < 160GB

Main Unit

- Power supply:
 - Latin America/Asia Pacific: 110-127V/220-240V; ~50-60Hz switchable
 - Russia/China/India: 220-240V, ~50Hz
- Power consumption: 135 W
- Standby power consumption: < 0.9 W
- Dimensions (WxHxD): 435 x 58 x 358 (mm)
- Weight: 3.87 kg

Subwoofer

- Impedance: 3 ohm
- Speaker drivers: 203 mm (8") woofer
- Frequency response: 20 Hz-150 Hz
- Dimensions (WxHxD): 196 x 395 x 342 (mm)
- Weight: 5.37 kg
- Cable length: 3 m

Speakers

- System: full range satellite
- Speaker impedance: 3 ohm (center), 5 ohm (Front/Rear)
- Speaker drivers: 2 x 3" full range
- Frequency response: 150 Hz-20 kHz
- Dimensions (WxHxD):
 - Center: 280 x 95 x 92 (mm)
 - Speaker : 100 x 280 x 115 (mm)
 - Tall speaker: 260 x 1101 x 260 (mm)
- Weight:
 - Center: 1.40 kg
 - Speaker: 0.98~1.05 kg/each
 - Tall speaker: 3.73~3.81 kg/each
- Cable length:
 - Center: 2 m
 - Front: 3 m
 - Rear: 10 m

Laser Specification

- Laser Type (Diode): InGaN/AlGaIn (BD), InGaAlP (DVD), AlGaAs (CD)
- Wave length: 405 +5nm/-5nm (BD), 650 +13nm/-10nm (DVD), 790 +15nm/-15nm (CD)
- Output power (Max. ratings): 20mW (BD), 7mW (DVD/CD)

9 Troubleshooting



Warning

- Risk of electric shock. Never remove the casing of the product.

To keep the warranty valid, never try to repair the product yourself.

If you have problems using this product, check the following points before you request service. If you still have a problem, register your product and get support at www.philips.com/welcome.

If you contact Philips, you will be asked for the model and serial number of your product. The model number and serial number are on the back or bottom of your product. Write the numbers here:

Model No. _____

Serial No. _____

Main unit

The buttons on this home theater do not work.

- Disconnect the home theater from the power outlet for a few minutes, then reconnect.

Picture

No picture.

- Ensure that the TV is switched to the correct source for the home theater.

No picture on HDMI connection.

- Change the HDMI video setting or wait for 15 seconds for auto recover.
- Check if the HDMI cable is faulty. Replace with a new HDMI cable.

No picture on the Component (Y Pb Pr) connection.

- If the HDMI video connection is set to **[Auto]** or **[1080p/24Hz]**, there is no video output through the component connection. Change the HDMI video setting or remove the HDMI connection.

No high-definition video signal on the TV.

- Ensure that the disc contains high-definition video.
- Ensure that the TV supports high-definition video.

Sound

No sound.

- Ensure that the audio cables are connected and select the correct input source (for example, **JSOURCE / AUDIO SOURCE**) for the device you want to play.

No sound on HDMI connection.

- You might not hear any sound if the connected device is not HDCP (High-bandwidth Digital Content Protection) compliant or only DVI compatible. Use an analog or digital audio connection.
- Ensure that the **[HDMI Audio]** is enabled.

No sound from TV program.

- Connect an audio cable from the audio input on the home theater to the audio output on the TV, then press **JSOURCE / AUDIO SOURCE** repeatedly to select the correct audio source.

Distorted sound or echo.

- Ensure that the TV volume is muted or set to minimum if you are playing audio through the home theater.

Audio and video are not synchronized.

- 1) Press **HSOUND SETTINGS /** **(Sound options)**. 2) Press the **Navigation buttons** (left/right) repeatedly until **AUDIO SYNC** is displayed, then press **OK**. 3) Press the **Navigation buttons** (up/down) to sync the audio with the video.

No sound from the rear speakers and the indicator on the wireless receiver blinks continuously for more than one minute.

- Check whether there is any interference from nearby electronic devices, remove the conflict or strong interference, then try the procedures: 1) Disconnect the power cord from the wireless receiver for a few seconds and connect it back again. 2) Press **JSOURCE/AUDIO SOURCE** on the remote control to select 'AUX' or 'MP3 LINK'. 3) Press and hold **Navigation buttons** (right) until 'PAIRING' flashes on the display panel. 4) If 'FAILED' is displayed, repeat the above steps.

Play

Disc cannot be played.

- Clean the disc.
- Ensure that the home theater supports the disc (see 'Product specifications' on page 24).
- Ensure that the home theater supports the region code of the disc.
- For DVD±RW or DVD±R, ensure that the disc is finalized.

DivX video files cannot be played.

- Ensure that the DivX file is encoded according to the 'Home Theater Profile' with the DivX encoder.
- Ensure that the DivX video file is complete.

DivX subtitles do not display correctly.

- Ensure that the subtitle file name is the same as the movie file name.
- Select the correct character set: 1) Press **≡** **OPTIONS** / **Ⓞ** (**Options**). 2) Select **[Character Set]**. 3) Select the supported character set. 4) Press **OK**.

The contents of a USB storage device cannot be read.

- Ensure that the format of the USB storage device is compatible with the home theater (see 'Product specifications' on page 24).
- Ensure that the USB storage device is formatted with a file system that is supported by the home theater.

'No entry' or 'x' sign appears on the TV.

- The operation is not possible.

EasyLink feature does not work.

- Ensure that the home theater is connected to a Philips brand EasyLink TV and that EasyLink is on.

I do not want my home theater to be switched on when I switch on my TV.

- This is the correct behavior for Philips EasyLink (HDMI-CEC). To make the home theater work independently, switch off EasyLink.

I cannot access BD-Live features.

- Check the network connection (see 'Connect to a computer network and the Internet' on page 12) or ensure that the network has been set up (see 'Set up network' on page 12).
- Clear memory storage. (see 'Change advanced settings' on page 22)

- Ensure that the Blu-ray disc supports BD-Live feature.

The video (movies, photos, video clips, etc.) contents of the iPod/iPhone do not display on TV.

- Video and photo browsing is not supported, you can only browse the video and photo contents on the iPod/iPhone itself.

Cannot see pictures from my iPod/iPhone on the TV.

- Connect a yellow composite cable from the dock to the TV.
- Switch the TV to the **AV/VIDEO** source (corresponding to the yellow composite cable).
- Press **PLAY** on the iPod or iPhone to start the slideshow.

The audio is interrupted when I play music from my iPod or iPhone in the docking station.

- Ensure that you have installed the latest firmware on your iPod or iPhone. For more information, refer to the support website of your iPod or iPhone.

My 3D video plays in 2D mode.

- Ensure that your home theater is connected to your 3D TV through HDMI.
- Ensure that your disc is a Blu-ray 3D disc.
- Ensure that the **[Blu-ray 3D video]** setting is turned on (see 'Change video settings' on page 20).

I see black video on my TV screen.

- Ensure that your home theater is connected to the TV through HDMI.
- Switch to the correct HDMI source on your TV.

10 Index

3

3D video 15

A

amplifier 24

audio

connection 11

language 22

settings 21

synchronize with video 14

audio input mapping 19, 21

B

BD-Live

access 15

set up 12

Bonus View 15

Browse

PC 18

C

care 4

change settings 20

chapter 16

connect

audio from TV 11, 19

guide 9

network 12

other devices 11

TV 10

wireless module 11

connectors 9

contact us 26

D

disc

play 14

supported discs 24

disposal of your product 5

DivX

character set 16

DLNA 17

E

EasyLink

settings 19, 21

F

file formats 24

H

HDMI CEC (see Easylink) 19

I

Internet

BD-Live 15

connect 12

software update 23

iPod

play 19

slideshow 19

L

language

audio 16, 22

disc menu 22

on-screen display 22

subtitle 16, 22

M

media server software

set up 17

MP3

play 19

N

network

connect 12

set up 12

software update 23

O

one-touch play 19, 21

one-touch standby 19, 21

overview

connectors 9

main unit 6

remote control 6

<hr/>	
P	
password (PIN code)	22
picture	
options	17
rotate	17
slide show	17
troubleshooting	26
picture-in-picture	
2nd audio language	15
2nd subtitle language	15
enable	15
play	
2D video	16
3D video	15
disc	14
from PC	17
MP3 player	19
multimedia content	17
options	14
radio	18
troubleshooting	27
USB storage device	16
product care	4
product specifications	24
progressive scan	2
<hr/>	
R	
radio	
play	18
program	18
tune	18
recycle	5
region code	24
remote control	6
repeat	16, 14
rotate pictures	17
<hr/>	
S	
safety	4
settings	
audio	21
EasyLink	21
parental control	22
preferences	22
slideshow	
animation	17
duration	17
play from iPod/iPhone	19
play musical slideshow	17
software	
update	23
version	23
<hr/>	
sound	
auto volume	13
mode	13
surround	14
treble and bass	14
troubleshooting	26
subtitle	
language	16, 22
subtitle shift	16, 22
system audio control	19
<hr/>	
T	
time search video	16
title	16
troubleshooting	26
TV	
audio from TV	11, 19
connect	10
<hr/>	
U	
USB	
play	16
software update	24
<hr/>	
V	
video	
options	16
synchronize with audio	14
<hr/>	
W	
wireless	
wireless module	11

Language Code

Abkhazian	6566
Afar	6565
Afrikaans	6570
Amharic	6577
Arabic	6582
Armenian	7289
Assamese	6583
Avestan	6569
Aymara	6589
Azerbaijani	6590
Bahasa Melayu	7783
Bashkir	6665
Belarusian	6669
Bengali	6678
Bihari	6672
Bislama	6673
Bokmål, Norwegian	7866
Bosanski	6683
Brezhoneg	6682
Bulgarian	6671
Burmese	7789
Castellano, Español	6983
Catalán	6765
Chamorro	6772
Chechen	6769
Chewa; Chichewa; Nyanja	7889
中文	9072
Chuang; Zhuang	9065
Church Slav; Slavonic	6785
Chuvash	6786
Corsican	6779
Česky	6783
Dansk	6865
Deutsch	6869
Dzongkha	6890
English	6978
Esperanto	6979
Estonian	6984
Euskara	6985
Ελληνικά	6976
Faroese	7079
Français	7082
Frysk	7089
Fijian	7074
Gaelic; Scottish Gaelic	7168
Gallegan	7176
Georgian	7565
Gikuyu; Kikuyu	7573
Guarani	7178
Gujarati	7185
Hausa	7265
Herero	7290
Hindi	7273
Hiri Motu	7279
Hrvatski	6779
Ido	7379
Interlingua (International)	7365
Interlingue	7365
Inuktitut	7385

Inupiaq	7375
Irish	7165
Íslenska	7383
Italiano	7384
Ivrit	7269
Japanese	7465
Javanese	7486
Kalaallisut	7576
Kannada	7578
Kashmiri	7583
Kazakh	7575
Kernewek	7587
Khmer	7577
Kinyarwanda	8287
Kirghiz	7589
Komi	7586
Korean	7579
Kuanyama; Kwanyama	7574
Kurdish	7585
Lao	7679
Latina	7665
Latvian	7686
Letzeburgesch;	7666
Limburgan; Limburger	7673
Lingala	7678
Lithuanian	7684
Luxembourgish;	7666
Macedonian	7775
Malagasy	7771
Magyar	7285
Malayalam	7776
Maltese	7784
Manx	7186
Maori	7773
Marathi	7782
Marshallese	7772
Moldavian	7779
Mongolian	7778
Nauru	7865
Navaho; Navajo	7886
Ndebele, North	7868
Ndebele, South	7882
Ndonga	7871
Nederlands	7876
Nepali	7869
Norsk	7879
Northern Sami	8369
North Ndebele	7868
Norwegian Nynorsk;	7878
Occitan; Provençal	7967
Old Bulgarian; Old Slavonic	6785
Oriya	7982
Oromo	7977
Ossetian; Ossetic	7983
Pali	8073
Panjabi	8065
Persian	7065
Polski	8076
Português	8084

Pushto	8083
Russian	8285
Quechua	8185
Raeto-Romance	8277
Romanian	8279
Rundi	8278
Samoan	8377
Sango	8371
Sanskrit	8365
Sardinian	8367
Serbian	8382
Shona	8378
Shqip	8381
Sindhi	8368
Sinhalese	8373
Slovensky	8373
Slovenian	8376
Somali	8379
Sotho; Southern	8384
South Ndebele	7882
Sundanese	8385
Suomi	7073
Swahili	8387
Swati	8383
Svenska	8386
Tagalog	8476
Tahitian	8489
Tajik	8471
Tamil	8465
Tatar	8484
Telugu	8469
Thai	8472
Tibetan	6679
Tigrinya	8473
Tonga (Tonga Islands)	8479
Tsonga	8483
Tswana	8478
Türkçe	8482
Turkmen	8475
Twi	8487
Uighur	8571
Ukrainian	8575
Urdu	8582
Uzbek	8590
Vietnamese	8673
Volapuk	8679
Walloon	8765
Welsh	6789
Wolof	8779
Xhosa	8872
Yiddish	8973
Yoruba	8979
Zulu	9085

