

Register your product and get support at  
[www.philips.com/welcome](http://www.philips.com/welcome)

**Immersive**  
3000 series



# Quick start guide

**PHILIPS**



**EN** Before using your product, read all accompanying safety information

**CS** Před použitím produktu si přečtěte doprovodné bezpečnostní informace

**DA** Læs alle medfølgende sikkerhedsoplysninger, inden du tager produktet i brug

**DE** Lesen Sie vor Verwendung dieses Produkts alle begleitenden Sicherheitsinformationen

**EL** Πριν χρησιμοποιήσετε το προϊόν, διαβάστε όλες τις παρεχόμενες πληροφορίες ασφάλειας

**ES** Antes de usar el producto, lea toda la información de seguridad adjunta

**FI** Lue kaikki turvallisuustiedot ennen tuotteen käyttöä

**FR** Avant d'utiliser votre produit, lisez l'intégralité des consignes de sécurité jointes

**HU** A termék használatá előtt alaposan olvassa el a mellékelt biztonasági tudnivalókat

**IT** Prima di utilizzare il prodotto, leggere tutte le relative informazioni sulla sicurezza

**NL** Lees voordat u het product gaat gebruiken eerst alle bijbehorende veiligheidsinformatie

**NO** Lees voordat u het product gaat gebruiken eerst alle bijbehorende veiligheidsinformatie

**PL** Przed rozpoczęciem korzystania z produktu należy zapoznać się z informacjami dotyczącymi bezpieczeństwa

**PT** Antes de utilizar o produto, leia todas as informações de segurança que o acompanham

**RO** Înainte de a utiliza acest produs, citiți toate informațiile de siguranță care îl însoțesc

**SK** Pred použitím produktu si prečítajte všetky sprievodné bezpečnostné informácie maklumat keselamatan yang disertakan

**SV** Innan du använder produkten ska du läsa all tillhörande säkerhetsinformation

**TR** Ürününüzü kullanmadan önce ilgili tüm güvenlik bilgilerini okuyun

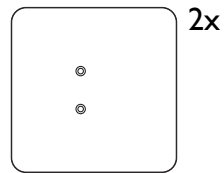
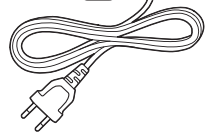
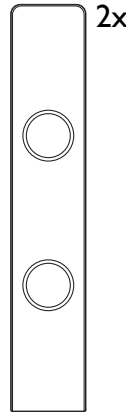
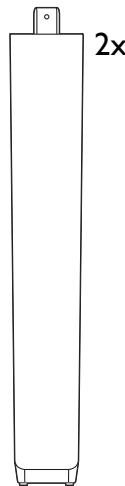
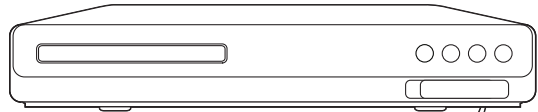
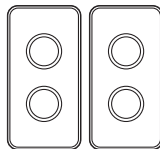
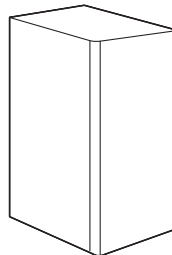
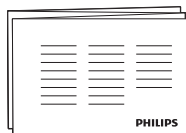
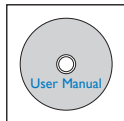
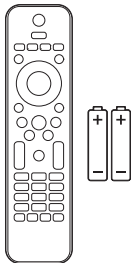

# 1

**EN** Stand mount the speakers

**CS** Nainstalujte reproduktory

**DA** Monter højttalerne på fod

**DE** Montage der Lautsprecher auf den Standfüßen

**EL** Στήστε τα ηχεία πάνω στις βάσεις

**ES** Monta los altavoces en la pared

**FI** Kaiuttimien kiinnitys jalustaan

**FR** Monter le pied des enceintes

**HU** A hangsugárzók állványra szerelése

**IT** Montaggio degli altoparlanti su supporto

**NL** Monteer de luidsprekers op de standaarden

**NO** Montere høyttalerne på stativ

**PL** Montaż głośników na podstawie

**PT** Colocar os altifalantes no suporte

**RO** Montați pe suport boxeale

**SK** Montáž reproduktorov na stojan

**SV** Montera högtalarna på stativ

**TR** Hoparlörleri kaideye monte edin

# 1

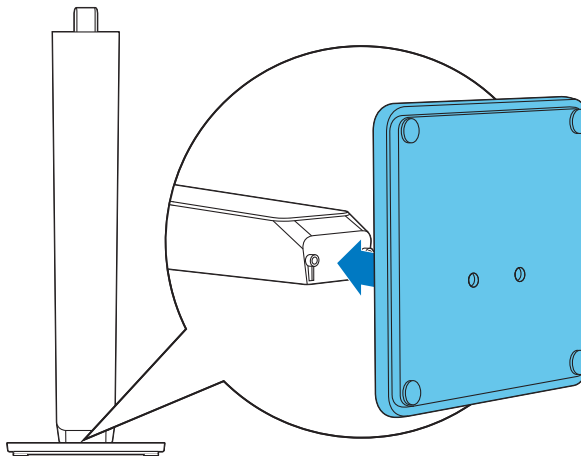

2

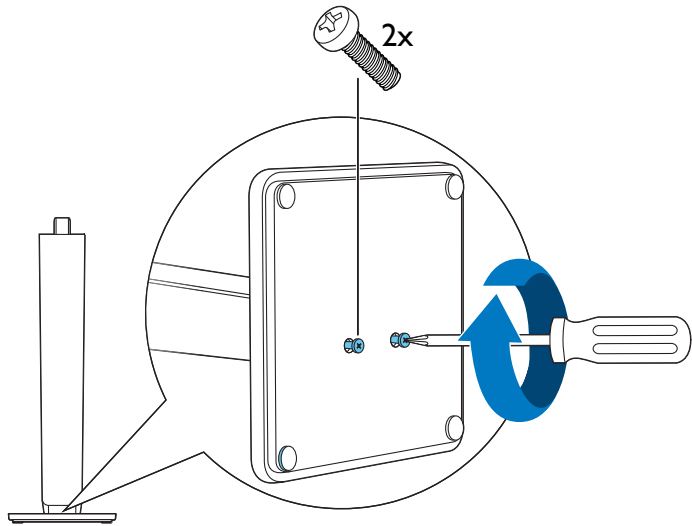

3

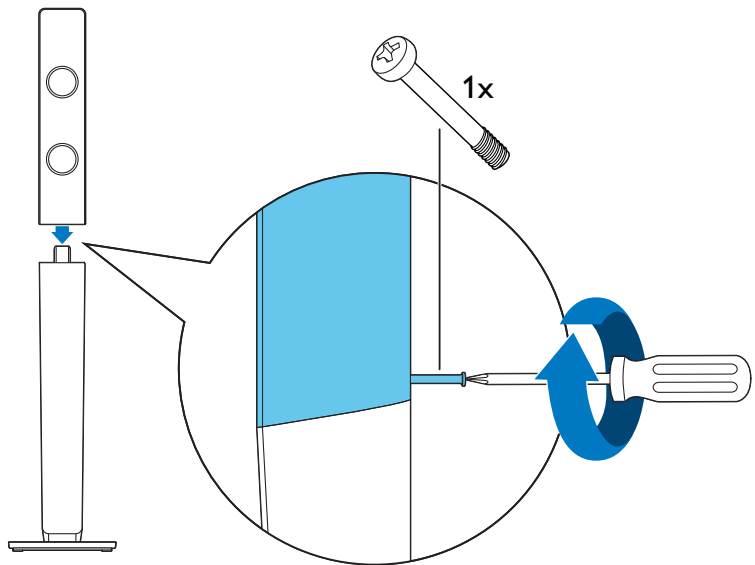

# 2

- EN** Connect the home theater
- CS** Připojte domácí kino
- DA** Tilslut hjemmebiografen
- DE** Anschließen des Home Entertainment-Systems
- EL** Συνδέστε το home cinema
- ES** Conecta el sistema de cine en casa
- FI** Kotiteatterin liittäminen
- FR** Connecter les enceintes au Home Cinéma
- HU** A házimozi csatlakoztatása
- IT** Collegamento del sistema Home Theater

- NL** Sluit de home cinema aan
- NO** Koble til hjemmekinoanlegget
- PL** Podłączenie zestawu kina domowego
- PT** Efectuar as ligações ao sistema de cinema em casa
- RO** Conectați sistemul home theater
- SK** Pripojenie k domácemu kinu
- SV** Anslut hemmabiosystemet
- TR** Ev sinemasını bağlayın

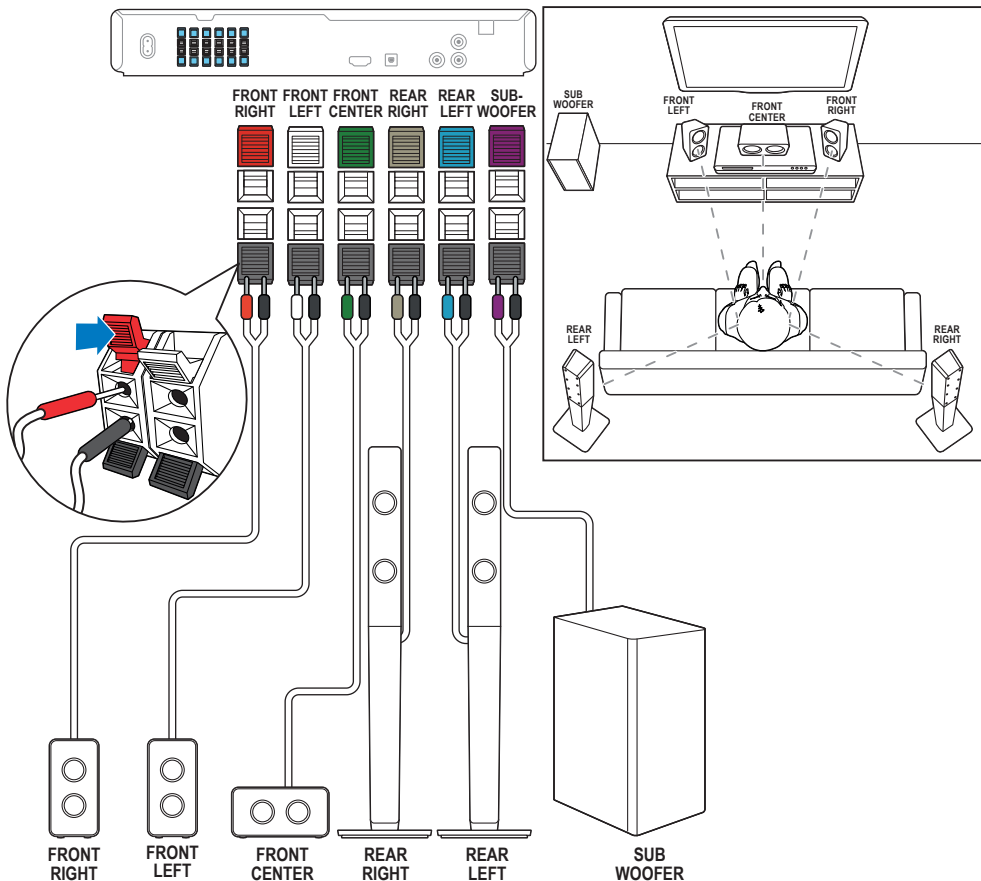

# 3

**EN** Connect to TV in one of these ways

**CS** Připojení k televizoru proveďte jedním z následujících způsobů

**DA** Tilslut til TV på en af følgende måder

**DE** Herstellen einer Verbindung mit dem Fernseher über einer dieser Möglichkeiten

**EL** Συνδεθείτε στην τηλεόραση με έναν από τους παρακάτω τρόπους

**ES** Conexión al televisor de una de estas maneras

**FI** Liitä televisioon jommallakummalla tavalla

**FR** Connectez-vous au téléviseur via l'une de ces méthodes

**HU** Csatlakoztassa a tv-készülékhez az alábbi módok egyike szerint

**IT** Eseguì il collegamento al TV in uno dei modi indicati di seguito

**NL** Maak op een van de volgende manieren verbinding met de TV

**NO** Koble til TV'en på en av følgende måter

**PL** Podłącz do telewizora przy użyciu jednej z tych metod

**PT** Ligar ao televisor de uma destas formas

**RO** Conectați-vă la televizor într-unul din aceste moduri

**SK** Pripojte zariadenie k televizoru jedným z týchto spôsobov

**SV** Anslut till TV:n på något av följande sätt

**TR** Aşağıdaki yöntemlerden biriyle TV'ye bağlanın

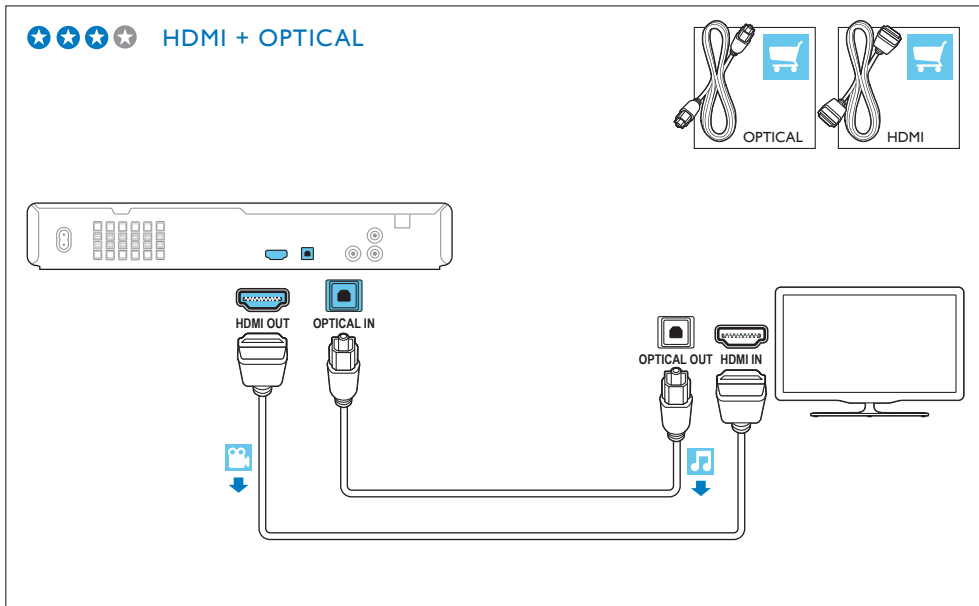

★ ★ ★ ★ HDMI + AUDIO L/R

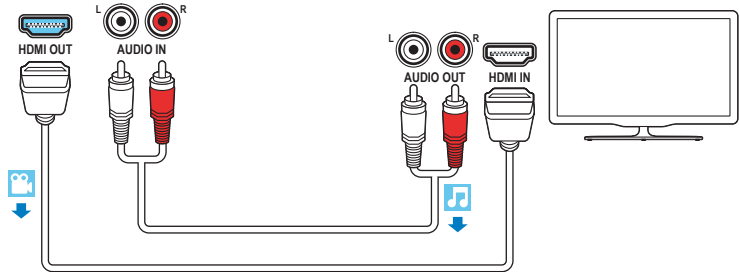

★ ★ ★ ★ VIDEO + AUDIO L/R

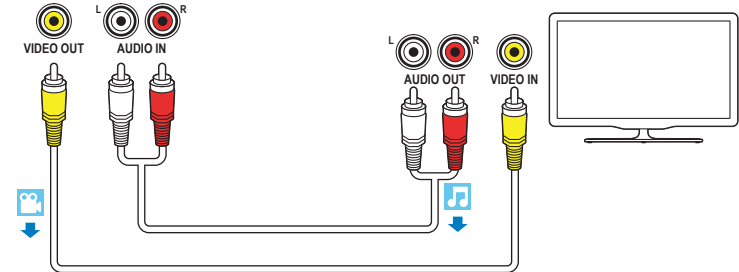

# 4

**EN** Switch on the home theater

**CS** Zapněte domácí kino

**DA** Tænd for hjemmebiografen

**DE** Einschalten des Home Entertainment-Systems

**EL** Ενεργοποιήστε το home cinema

**ES** Enciende el sistema de cine en casa

**FI** Virran kytkeminen kotiteatteriin

**FR** Mettre sous tension le Home Cinéma

**HU** A házimozi bekapcsolása

**IT** Accensione del sistema Home Theater

**NL** Schakel de home cinema in

**NO** Slå på hjemmekinoanlegget

**PL** Włączanie zestawu kina domowego

**PT** Ligar o sistema de cinema em casa

**RO** Porniți sistemul home theater

**SK** Zapnutie domáceho kina

**SV** Sätt på hemmabiosystemet

**TR** Ev sinemasını açın

1

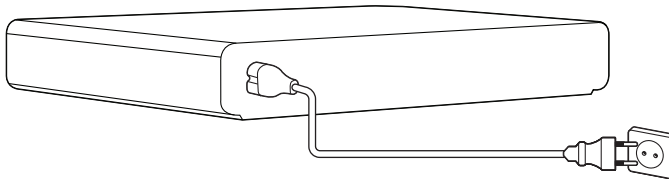

2

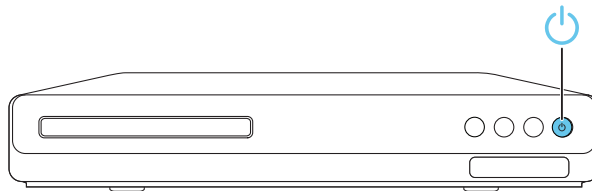

3

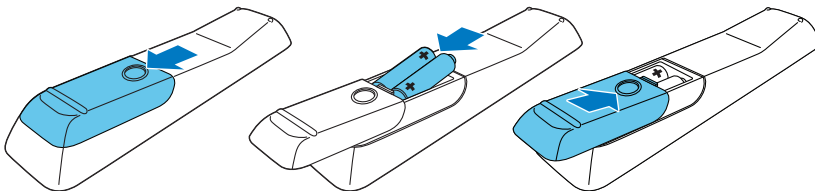



# 5

**EN** Complete the first time setup

**CS** Dokončíte jsté nastavení při prvním zapnutí

**DA** Fuldfør den indledende opsætning

**DE** Abschließen der Ersteinrichtung

**EL** Ολοκληρώστε τη ρύθμιση για πρώτη φορά

**ES** Finaliza la configuración inicial

**FI** Ensiasennuksen suorittaminen loppuun

**FR** Effectuer la configuration initiale

**HU** Az első üzembe helyezés

**IT** Completamento della configurazione iniziale

**NL** Volttooí de eerste installatie

**NO** Fullfør den første konfigureringen

**PL** Pierwsza konfiguracja

**PT** Executar a configuração inicial

**RO** Realizați prima configurare

**SK** Dokončenie prvého nastavenia

**SV** Slutför förstagångsinställningen

**TR** İlk kullanım öncesi kurulumunu tamamlayın

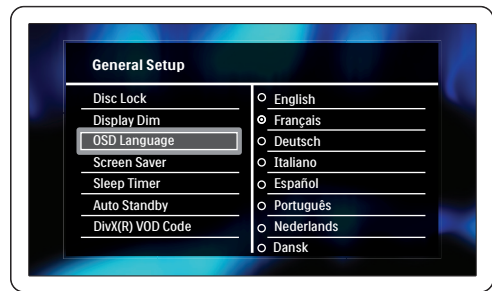
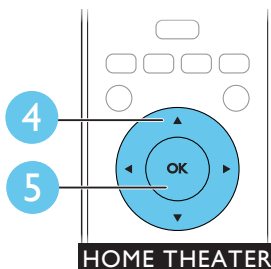
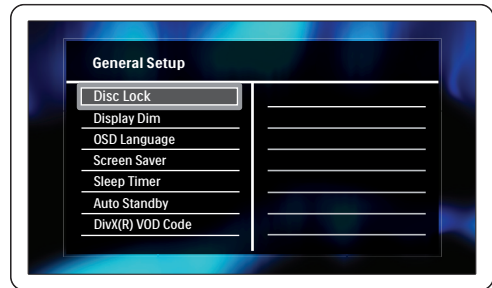
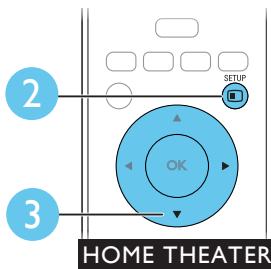
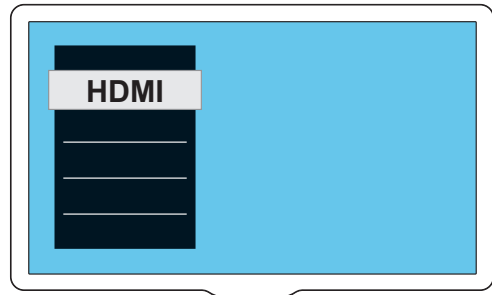
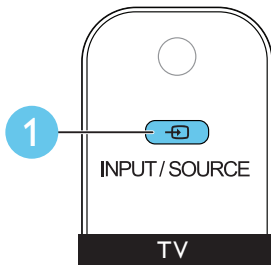

# 6

**EN** Use your home theater

**CS** Použití domácího kina

**DA** Brug af din hjemmebiograf

**DE** Verwenden des Home Entertainment-Systems

**EL** Χρησιμοποιήστε το home cinema

**ES** Uso del sistema de cine en casa

**FI** Kotiteatterin käyttäminen

**FR** Utiliser votre Home Cinéma

**HU** A házi mozi használat

**IT** Utilizzo del sistema Home Theater

**NL** Uw home cinema bedienen

**NO** Bruke hjemmekinoanlegget

**PL** Korzystanie z zestawu kina domowego

**PT** Utilizar o sistema de cinema em casa

**RO** Utilizați sistemul home theater

**SK** Používanie domáceho kina

**SV** Använda hemmabiosystemet

**TR** Ev sinema sisteminin kullanılması

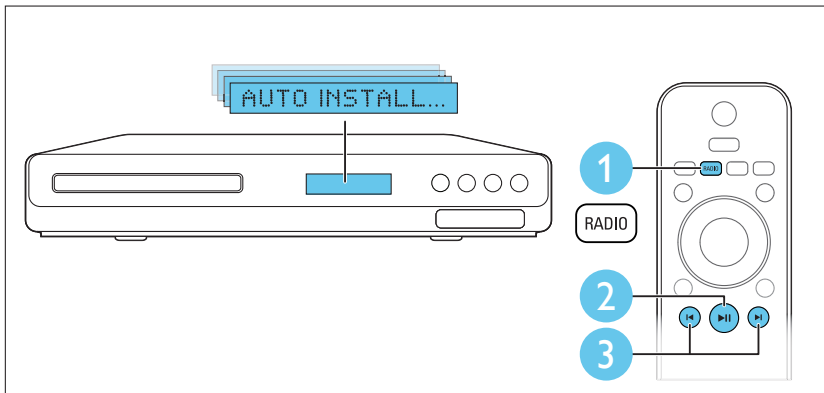
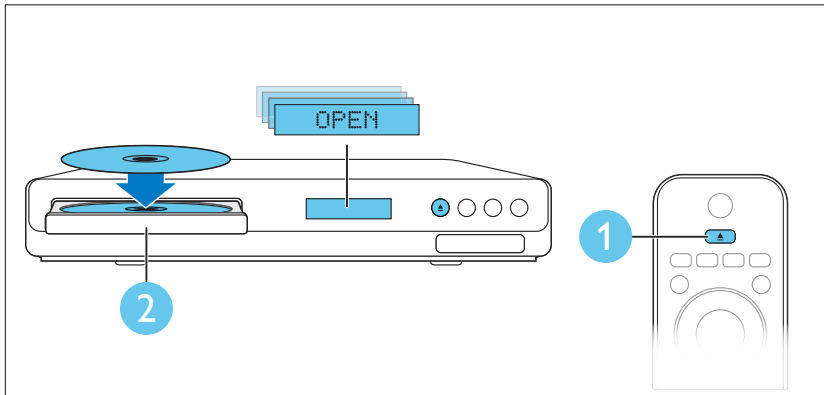

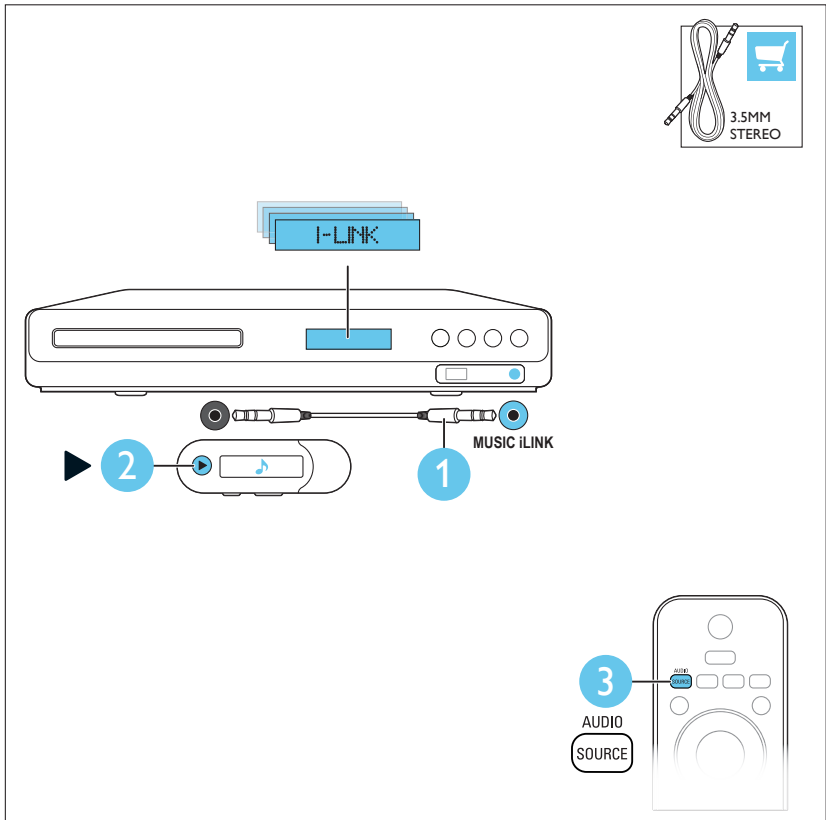
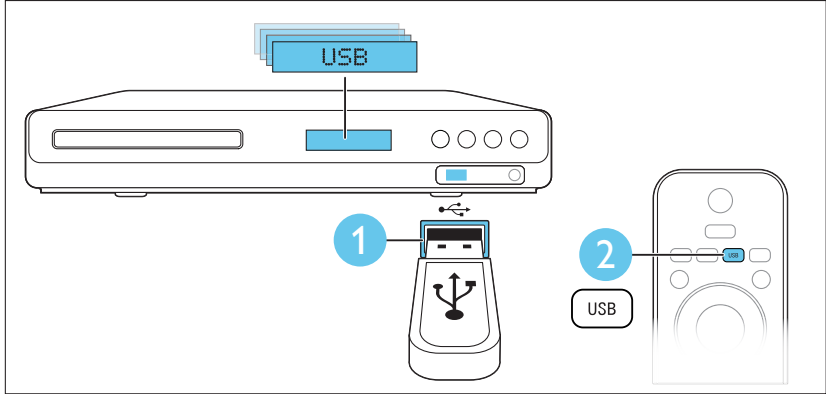



**EN** For more information about using this product, visit [www.philips.com/support](http://www.philips.com/support)

**DA** Du kan finde yderligere oplysninger om brugen af dette produkt på [www.philips.com/support](http://www.philips.com/support)

**DE** Weitere Informationen zur Verwendung dieses Produkts finden Sie unter [www.philips.com/support](http://www.philips.com/support)

**EL** Για περισσότερες πληροφορίες σχετικά με τη χρήση αυτού του προϊόντος, επισκεφθείτε το [www.philips.com/support](http://www.philips.com/support)

**ES** Para obtener más información sobre este producto, visite [www.philips.com/support](http://www.philips.com/support)

**FI** Lue lisätietoa tuotteen käytöstä osoitteessa [www.philips.com/support](http://www.philips.com/support)

**FR** Pour obtenir davantage d'informations sur l'utilisation de ce produit, rendez-vous sur [www.philips.com/support](http://www.philips.com/support)

**IT** Per ulteriori informazioni sull'uso di questo prodotto, visitare il sito [www.philips.com/support](http://www.philips.com/support)

**NL** Ga voor meer informatie over dit product naar [www.philips.com/support](http://www.philips.com/support)

**NO** Hvis du vil ha mer informasjon om bruk av dette produktet, kan du gå til [www.philips.com/support](http://www.philips.com/support)

**PT** Para mais informações sobre a utilização deste produto, visite [www.philips.com/support](http://www.philips.com/support)

**SV** Mer information om att använda den här produkten finns på [www.philips.com/support](http://www.philips.com/support)

**TR** Bu ürünün kullanımı hakkında daha fazla bilgi için [www.philips.com/support](http://www.philips.com/support) adresini ziyaret edin

**CS** Více informací o použití výrobku naleznete na stránkách [www.philips.com/support](http://www.philips.com/support)

**HU** A termék használatával kapcsolatos további információkkal kapcsolatban tekintse meg a [www.philips.com/support](http://www.philips.com/support) weboldalt

**PL** Więcej informacji na temat korzystania z tego produktu można znaleźć na stronie [www.philips.com/support](http://www.philips.com/support)

**RO** Pentru informații suplimentare despre utilizarea acestui produs, vizitați [www.philips.com/support](http://www.philips.com/support)

**SK** Ďalšie informácie o používaní tohto výrobku nájdete na stránke [www.philips.com/support](http://www.philips.com/support)



[www.philips.com/support](http://www.philips.com/support)



Non-contractual images. / Images non contractuelles. / Außervertragliche Bilder.

All registered and unregistered trademarks are property of their respective owners.

Specifications are subject to change without notice

Trademarks are the property of Koninklijke Philips Electronics N.V. or their respective owners

2012 © Koninklijke Philips Electronics N.V. All rights reserved

[www.philips.com](http://www.philips.com)

sgsn\_1151/12\_v1



Be responsible  
Respect copyrights

