

Register your product and get support at
www.philips.com/welcome

SoundBar

3000 series



Quick start guide

PHILIPS

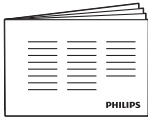

EN Before using your product, read all accompanying safety information

DA Læs alle medfølgende sikkerhedsoplysninger, inden du tager produktet i brug

DE Lesen Sie vor Verwendung dieses Produkts alle begleitenden Sicherheitsinformationen

EL Πριν χρησιμοποιήσετε το προϊόν, διαβάστε όλες τις παρεχόμενες πληροφορίες ασφάλειας

ES Antes de usar el producto, lea toda la información de seguridad adjunta

FI Lue kaikki turvallisustiedot ennen tuotteen käyttöä

FR Avant d'utiliser votre produit, lisez l'intégralité des consignes de sécurité jointes

IT Prima di utilizzare il prodotto, leggere tutte le relative informazioni sulla sicurezza

NL Lees voordat u het product gaat gebruiken eerst alle bijbehorende veiligheidsinformatie

NO Lees voordat u het product gaat gebruiken eerst alle bijbehorende veiligheidsinformatie

PT Antes de utilizar o produto, leia todas as informações de segurança que o acompanham

SV Innan du använder produkten ska du läsa all tillhörande säkerhetsinformation

TR Ürününüzü kullanmadan önce ilgili tüm güvenlik bilgilerini okuyun

CS Před použitím produktu si přečtěte doprovodné bezpečnostní informace

HU A termék használatá előtt alaposan olvassa el a mellékelt biztonsági tudnivalókat

PL Przed rozpoczęciem korzystania z produktu należy zapoznać się z informacjami dotyczącymi bezpieczeństwa

RO Înainte de a utiliza acest produs, citiți toate informațiile de siguranță care îl însoțesc

SK Pred použitím produktu si prečítajte všetky sprievodné bezpečnostné informácie

MS Sebelum menggunakan produk anda, baca semua maklumat keselamatan yang disertakan

**ZH
CN**

使用产品前，请阅读所有随附的安全信息

**ZH
TW**

使用您的產品前，請先閱讀所有附隨的安全資訊



- EN** What's in the box
- DA** Hvad følger med
- DE** Verpackungsinhalt
- EL** Περιεχόμενα συσκευασίας
- ES** Contenido de la caja
- FI** Pakkauksen sisältö
- FR** Contenu de l'emballage
- IT** Contenuto della confezione
- NL** De inhoud van de doos
- NO** Innholdet i esken
- PT** Conteúdo da embalagem
- SV** Vad finns i förpackningen?
- TR** Kutu içeriği
- CS** Obsah balení
- HU** A doboz tartalma
- PL** Zawartość opakowania
- RO** Ce se află în cutie
- SK** Obsah balenia
- MS** Apa dalam kotak ini

ZH 包装盒内物品

CN

ZH 包装盒内容

TW

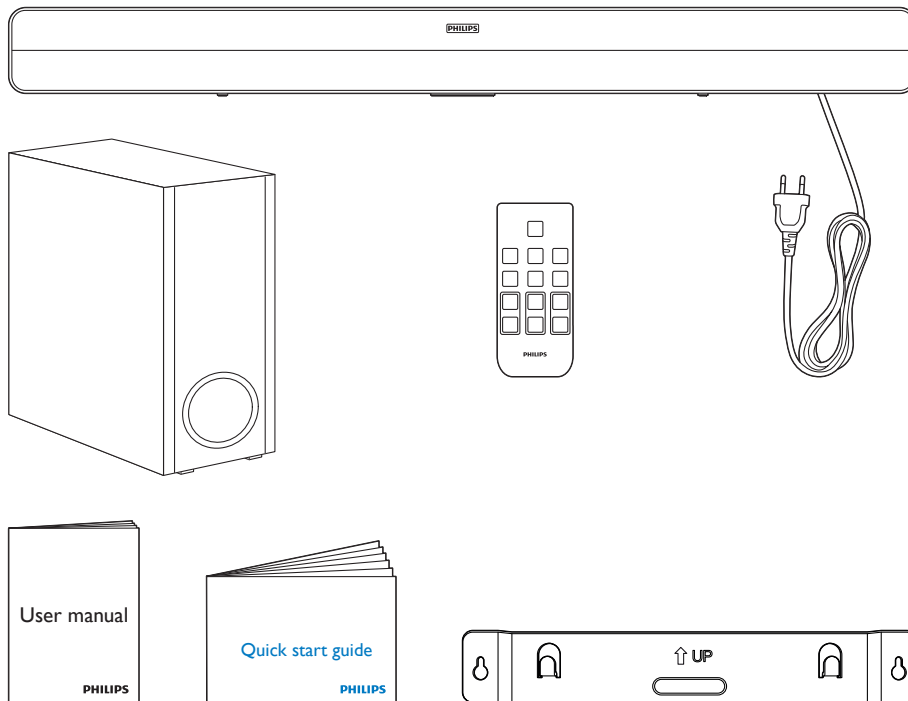

1

- EN** Position the SoundBar
- DA** Placer din SoundBar
- DE** Positionieren des SoundBars
- EL** Τοποθέτηση του SoundBar
- ES** Colocación del SoundBar
- FI** SoundBarin sijoittaminen
- FR** Placer la barre de son
- IT** Posizionamento della SoundBar
- NL** De SoundBar plaatsen
- NO** Plasser SoundBar
- PT** Posicionar o SoundBar
- SV** Placera SoundBar
- TR** SoundBar'ı yerleştirin
- CS** Umístění zařízení SoundBar
- HU** A SoundBar elhelyezése
- PL** Ustawianie zestawu SoundBar
- RO** Poziționare SoundBar
- SK** Umiestnite zariadenie SoundBar
- MS** Letakkan kedudukan SoundBar

ZH 摆放回音壁

CN

ZH 放置SoundBar

TW

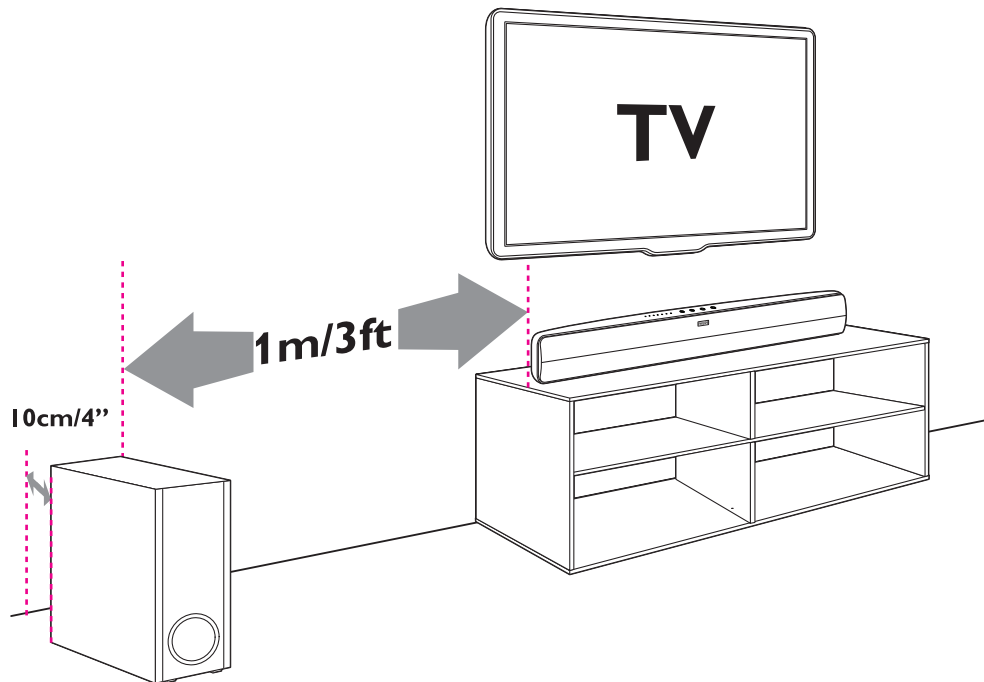

2

- EN** Connect the SoundBar
- DA** Tilslut din SoundBar
- DE** Anschließen des SoundBars
- EL** Σύνδεση του SoundBar
- ES** Conexión del SoundBar
- FI** SoundBarin liittäminen
- FR** Connecter la barre de son
- IT** Collegamento della SoundBar
- NL** De SoundBar aansluiten
- NO** Koble til SoundBar
- PT** Ligar os cabos do SoundBar
- SV** Ansluta SoundBar
- TR** SoundBar'ı bağlayın
- CS** Připojení zařízení SoundBar
- HU** A SoundBar csatlakoztatása
- PL** Podłączenie zestawu SoundBar
- RO** Conectare SoundBar
- SK** Pripojte zariadenie SoundBar
- MS** Sambung SoundBar

ZH 连接回音壁

CN

ZH 連接SoundBar

TW

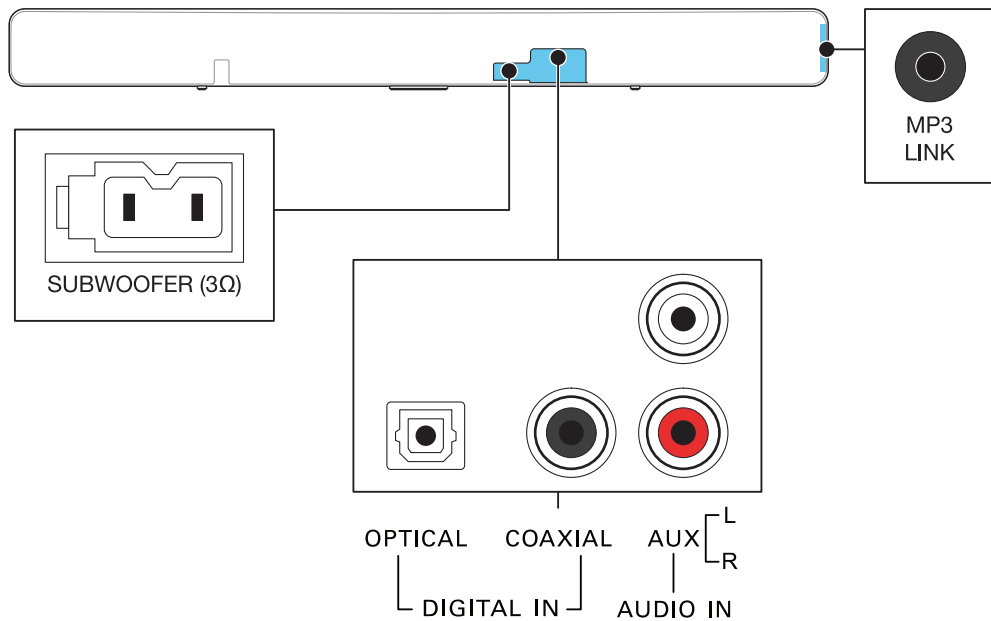

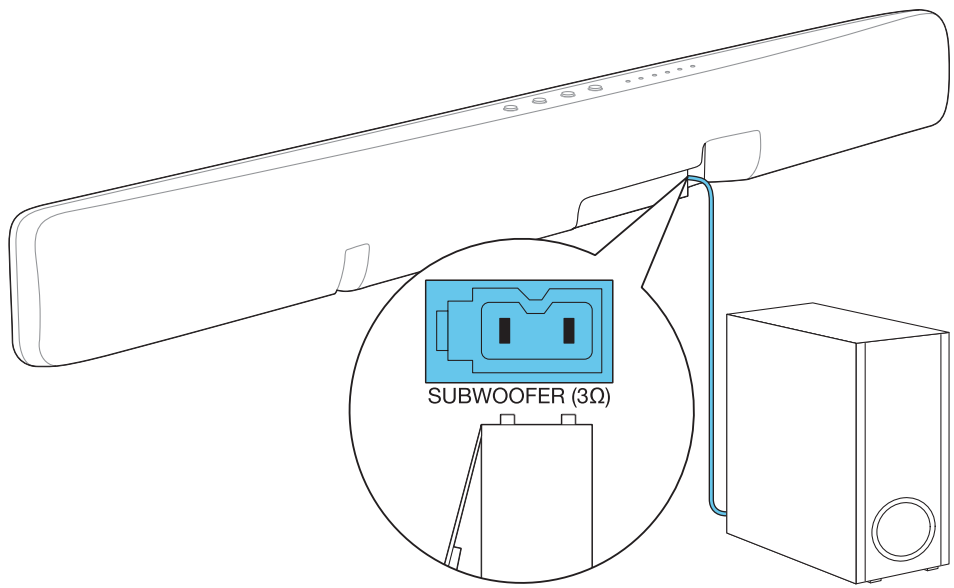

3

EN Connect the SoundBar to other devices

DA Tilslut SoundBar til andre enheder

DE Anschließen des SoundBar an andere Geräte

EL Σύνδεση του SoundBar σε άλλες συσκευές

ES Conexión del SoundBar a otros dispositivos

FI Liitä SoundBar muihin laitteisiin

FR Connecter la barre de son aux autres appareils

IT Collegamento della SoundBar ad altri dispositivi

NL De SoundBar op andere apparaten aansluiten

NO Koble SoundBar til andre enheter

PT Ligar o SoundBar a outros dispositivos

SV Anslut SoundBar till andra enheter

TR SoundBar'ı başka cihazlara bağlayın

CS Připojte zařízení SoundBar k dalším zařízením

HU A SoundBar csatlakoztatása más készülékekhez

PL Podłączenie zestawu SoundBar do innych urządzeń

RO Conectați SoundBar la alte dispozitive

SK Pripojte zariadenie SoundBar k iným zariadeniam

MS Sambungkan SoundBar ke peranti lain

ZH CN 将回音壁连接至其他设备

ZH TW 將 SoundBar 連接至其他裝置

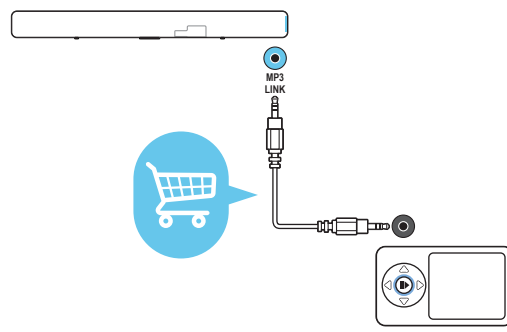
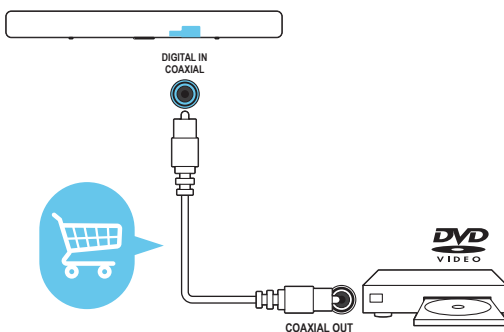
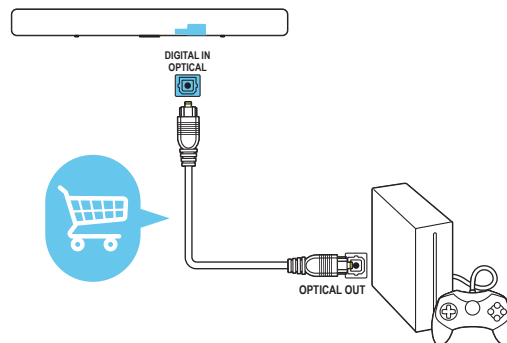
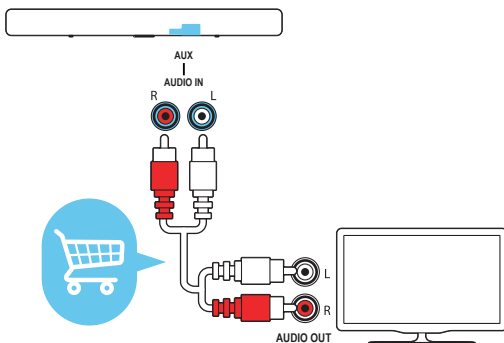

4

- EN** Manage cables
DA Håndter kabler
DE Kabel managen
EL Διαχείριση καλωδίων
ES Manejo de los cables
FI Kaapelien hallinta
FR Gestion des câbles
IT Gestione dei cavi
NL Kabels beheren
NO Ordne kablene
PT Gerir os cabos
SV Hantera kablar
TR Kablolan yönetme
CS Správa kabelů
HU Kábelek elvezetése
PL Układanie przewodów
RO Verificați cablurile
SK Usporiadanie káblov
MS Urus kabel
- ZH** 管理线缆
CN
ZH 管理纜線
TW

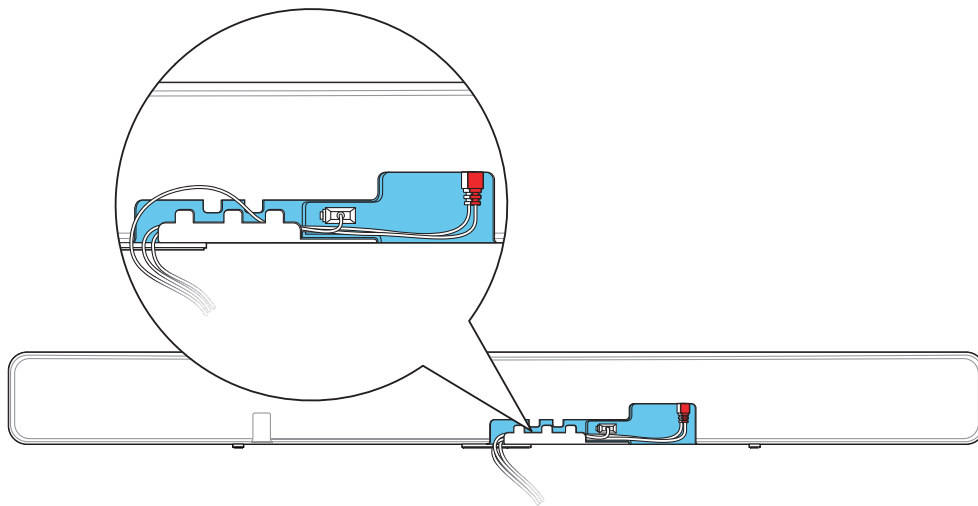

5

- EN** Switch on the SoundBar
- DA** Tænd for din SoundBar
- DE** Einschalten des SoundBars
- EL** Ενεργοποίηση του SoundBar
- ES** Encendido del SoundBar
- FI** SoundBarin käynnistäminen
- FR** Allumer la barre de son
- IT** Accensione della SoundBar
- NL** De SoundBar inschakelen
- NO** Slå på SoundBar
- PT** Ligar o SoundBar
- SV** Slå på SoundBar
- TR** SoundBar'ı açın
- CS** Zapnutí zařízení SoundBar
- HU** A SoundBar bekapcsolása
- PL** Włączanie zestawu SoundBar
- RO** Pornire SoundBar
- SK** Zapnite zariadenie SoundBar
- MS** Hidupkan SoundBar

ZH 打开回音壁
CN

ZH 啟動 SoundBar
TW

1

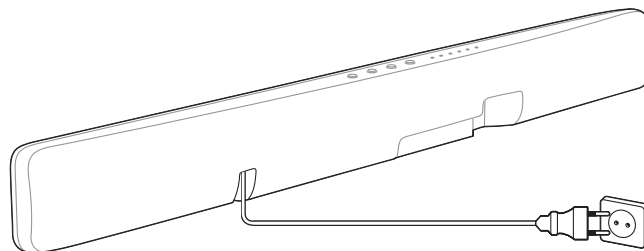

2

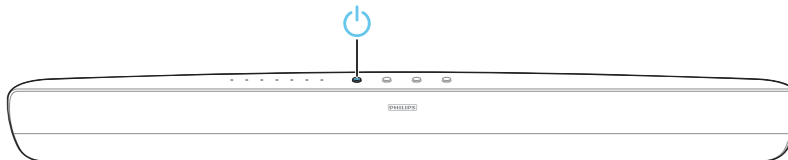

3

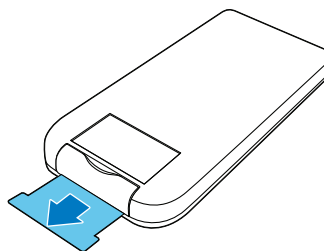

6

- EN** Select an audio source
- DA** Vælg en lydkilde
- DE** Auswählen einer Audioquelle
- EL** Επιλογή πηγής ήχου
- ES** Selección de una fuente de audio
- FI** Äänilähteen valitseminen
- FR** Sélectionner une source audio
- IT** Selezione di una sorgente audio
- NL** Een audiobron selecteren
- NO** Velg en lydkilde
- PT** Seleccionar uma fonte de áudio
- SV** Välja ljudkälla
- TR** Bir ses kaynağı seçin
- CS** Výběr zdroje zvuku
- HU** Egy audioforrás kiválasztása
- PL** Wybór źródła dźwięku
- RO** Selectare sursă audio
- SK** Vyberte zdroj zvuku
- MS** Pilih sumber audio

ZH 选择音频来源

CN

ZH 選擇音訊源

TW

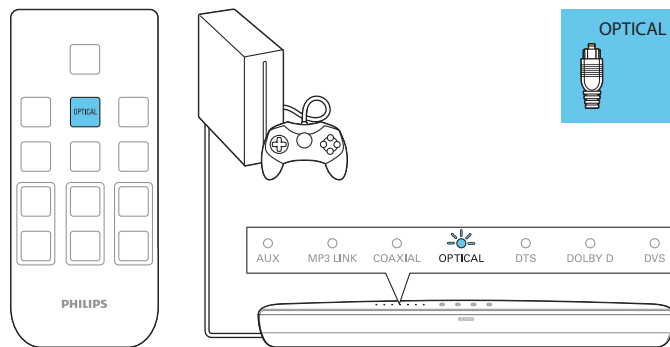
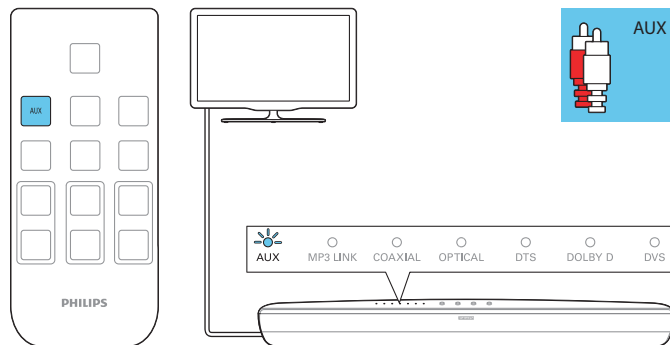

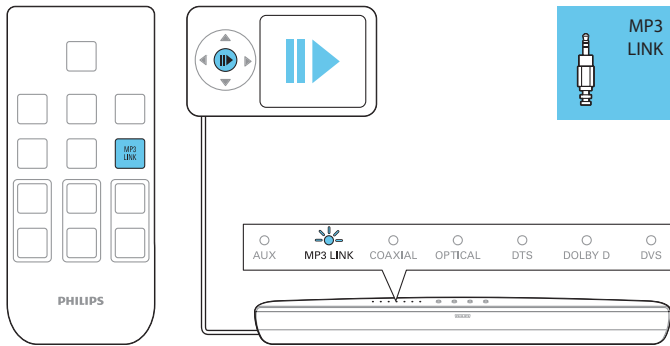
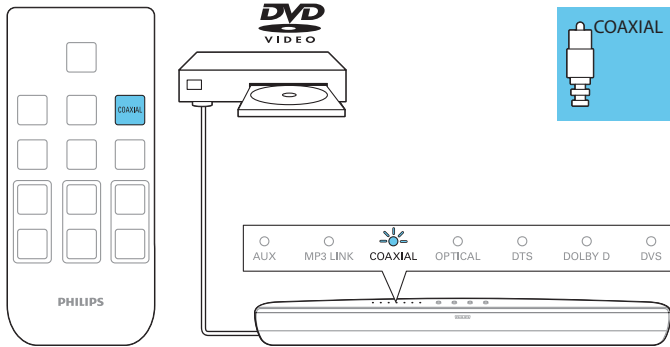

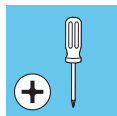

- EN** Wall mount the SoundBar (optional)
DA Monter din SoundBar på væggen (valgfrit)
DE Wandmontage des SoundBars (optional)
EL Επιτοίχια τοποθέτηση του SoundBar (προαιρετικά)
ES Montaje en pared del SoundBar (opcional)
FI SoundBarin kiinnittäminen seinään (valinnainen)
FR Fixer la barre de son sur un mur (facultatif)
IT Montaggio a parete della SoundBar (opzionale)
NL De SoundBar aan de wand bevestigen (optioneel)
NO Monter SoundBar på vegg (valgfritt)
PT Montar o SoundBar na parede (opcional)
SV Väggmontera SoundBar (valfritt)
TR SoundBar'ı duvara monte edin (isteğe bağlı)
CS Montáž zařízení SoundBar na stěnu (volitelné)
HU A SoundBar fali rögzítése (opcionális)
PL Montaż naścienny zestawu SoundBar (opcjonalnie)
RO Montare pe perete SoundBar (opțional)
SK Upevniť zariadenie SoundBar na stenu (voliteľné)
MS Lepakkan SoundBar pada dinding (pilihan)
ZH 挂墙安装回音壁
CN (可选)
ZH 掛牆安裝 SoundBar (可選)
TW

1

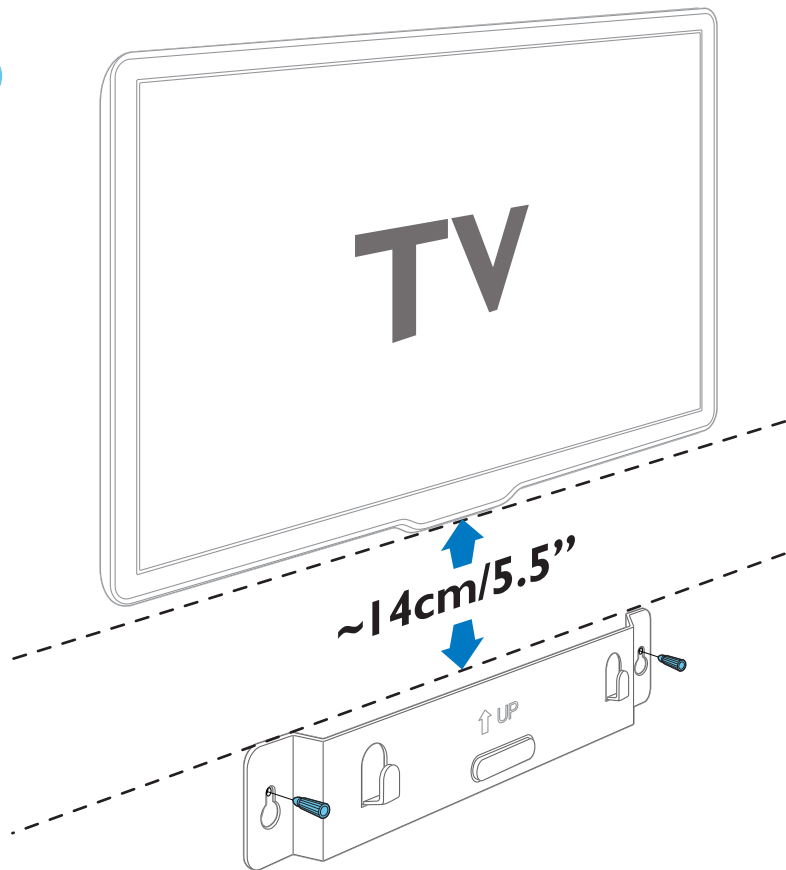

2

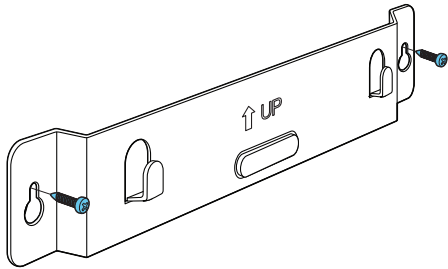

3

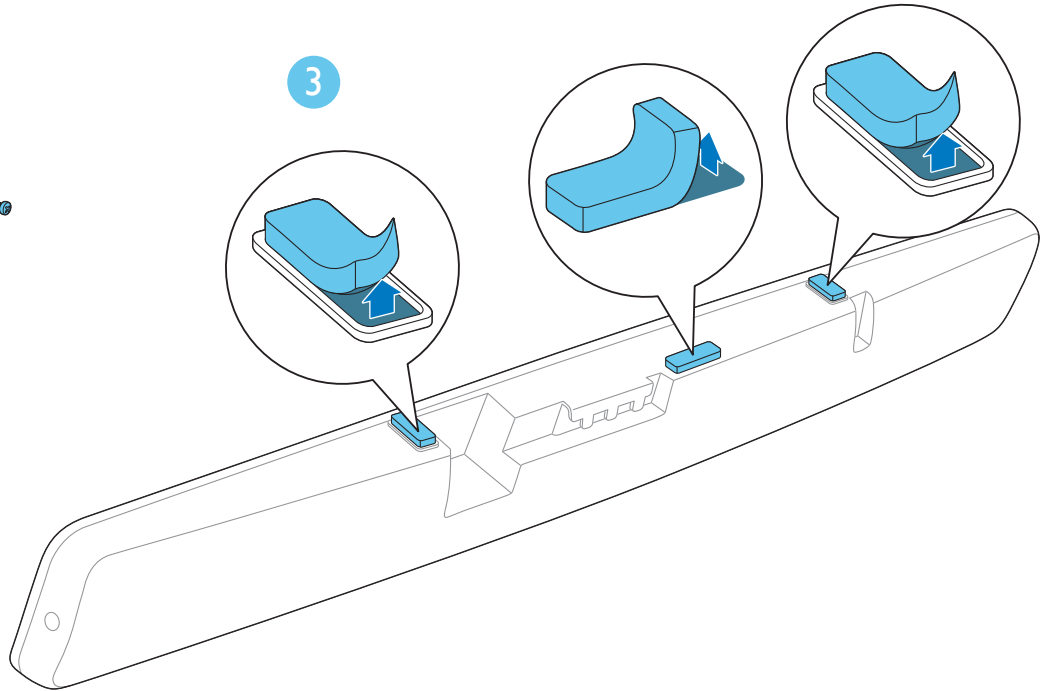

4

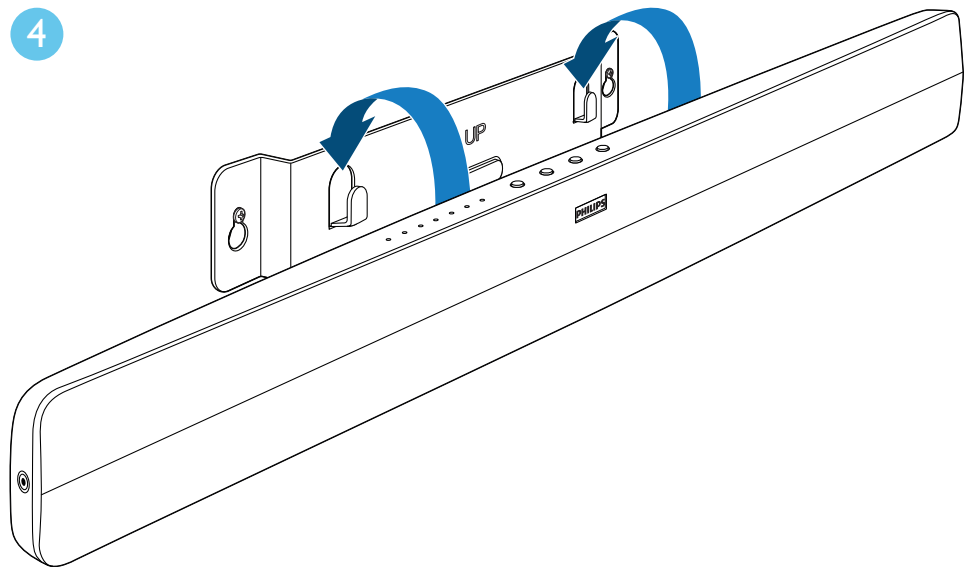



- EN** For more information about using this product, visit www.philips.com/support
- DA** Du kan finde yderligere oplysninger om brugen af dette produkt på www.philips.com/support
- DE** Weitere Informationen zur Verwendung dieses Produkts finden Sie unter www.philips.com/support
- EL** Για περισσότερες πληροφορίες σχετικά με τη χρήση αυτού του προϊόντος, επισκεφθείτε το www.philips.com/support
- ES** Para obtener más información sobre este producto, visite www.philips.com/support
- FI** Lue lisätietoja tuotteen käytöstä osoitteessa www.philips.com/support
- FR** Pour obtenir davantage d'informations sur l'utilisation de ce produit, rendez-vous sur www.philips.com/support
- IT** Per ulteriori informazioni sull'uso di questo prodotto, visitare il sito www.philips.com/support
- NL** Ga voor meer informatie over dit product naar www.philips.com/support
- NO** Hvis du vil ha mer informasjon om bruk av dette produktet, kan du gå til www.philips.com/support
- PT** Para mais informações sobre a utilização deste produto, visite www.philips.com/support
- SV** Mer information om att använda den här produkten finns på www.philips.com/support
- TR** Bu ürünün kullanımı hakkında daha fazla bilgi için www.philips.com/support adresini ziyaret edin
- CS** Více informací o použití výrobku naleznete na stránkách www.philips.com/support
- HU** A termék használatával kapcsolatos további információkkal kapcsolatban tekintse meg a www.philips.com/support weboldalt
- PL** Więcej informacji na temat korzystania z tego produktu można znaleźć na stronie www.philips.com/support
- RO** Pentru informații suplimentare despre utilizarea acestui produs, vizitați www.philips.com/support

- SK** Ďalšie informácie o používaní tohto výrobku nájdete na stránke www.philips.com/support
- MS** Untuk mendapatkan maklumat lanjut dalam menggunakan produk ini, lawati www.philips.com/support
- ZH** 有关使用本产品的更多信息，
CN 请访问 www.philips.com/support
- ZH** 有關此產品的更多資訊，請瀏覽
TW www.philips.com/support





Non-contractual images. / Images non contractuelles. / Außervertragliche Bilder.

All registered and unregistered trademarks are property of their respective owners.

Specifications are subject to change without notice

Trademarks are the property of Koninklijke Philips Electronics N.V. or their respective owners

2011 © Koninklijke Philips Electronics N.V. All rights reserved

www.philips.com

sgsn_1137/12/05/98_v5

