

Aina apuna

Rekisteröi tuote, voit käyttää tukipalvelua osoitteessa
www.philips.com/support

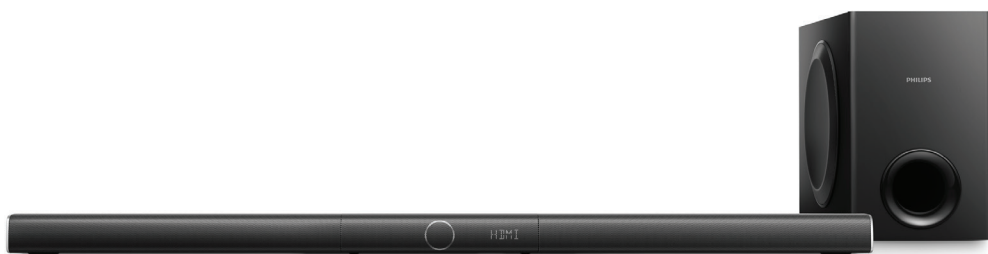

HTL5160B



Käyttöopas

PHILIPS

Sisällysluettelo

1 Tärkeää	2	6 Ohjelmiston päivittäminen	15
Turvallisuus	2	Ohjelmistoversion tarkistaminen	15
Tuotteen huolto	3	Ohjelmiston päivittäminen internetin kautta	15
Ympäristöstä huolehtiminen	3	Ohjelmistopäivitys USB-yhteyden kautta	16
Vaativuuden mukaisuus	3		
Ohje ja tuki	4	7 Seinäteline	17
Avoimen lähdekoodin ohjelmisto	4		
		8 Tuotetiedot	17
2 Tuote	4		
Päälaite	4	9 Vianmääritys	19
Kaukosäädin	5		
Liittimet	6		
Langaton subwoofer	6		
3 Liitännät	7		
Verkon määrittäminen	7		
Sijoittaminen	7		
Pariliitoksen muodostaminen subwooferiin	7		
Television äänilähtöliitäntä	8		
Äänen liittäminen muista laitteista	9		
Digitaalisten laitteiden liittäminen HDMI-liitäntään	10		
4 Sisäänrakennettu Chromecast ja Spotify Connect	10		
Laitteen liittäminen verkkoon	10		
Musiikin suoratoisto laitteessa	11		
Sovelluksen aloitusvalikon selaaminen	11		
5 Tuotteen käyttäminen	12		
Säädä äänenvoimakkuutta	12		
Äänen valinta	12		
Äänen toistaminen Bluetoothin kautta	13		
Bluetooth-yhteyden muodostaminen NFC:n kautta	13		
MP3-soitin	14		
USB-muistilaitteet	14		
Automaattinen valmiustila	14		
Näytön kirkkauden säätäminen	14		
Ota tehdasasetukset käyttöön	15		

1 Tärkeää

Perehdy kaikkiin ohjeisiin, ennen kuin alat käyttää tätä laitetta. Takuu ei ole voimassa, jos vika johtuu siitä, että ohjeita ei ole noudatettu.

Turvallisuus

Sähköiskun tai tulipalon vaara!

- Varmista ennen liitäntöjen tekemistä, että kaikki laitteet on irrotettu virtalähteestä.
- Älä altista tuotetta tai lisätarvikkeita sateelle tai vedelle. Älä aseta nestettä sisältäviä astioita kuten maljakoita tuotteen lähelle. Jos nesteitä kaatuu tuotteen päälle tai sisään, irrota laite heti verkkopistorasiasta. Ota yhteys kuluttajapalvelukeskukseen, jotta tuote tarkastetaan ennen käyttöä.
- Älä aseta tuotetta tai lisätarvikkeita avotulen tai muiden lämmönlähteiden lähelle tai suoraan auringonvaloon.
- Älä koskaan aseta esineitä ilmastointiukkoihin tai muihin tuotteen aukkoihin.
- Kun järjestelmän virta katkaistaan laitteen katkaisimesta tai irrottamalla pistoke, laite on helppo ottaa uudelleen käyttöön.
- Akkuja tai paristoja (asennettu) ei saa altistaa korkeille lämpötiloille, esimerkiksi auringonvalolle tai tulelle.
- Irrota tuotteen virtajohto pistorasiasta ennen ukkosmyrskyjä.
- Irrota virtajohto aina vetämällä pistokkeesta, ei johdosta.

Oikosulun tai tulipalon vaara!

- Tunniste- ja tehotiedot on mainittu laitteen takana olevassa arvokilvessä.
- Ennen kuin liität tuotteen pistorasiaan, varmista, että virran jännite vastaa laitteen takaseinään tai pohjaan painettua arvoa. Älä liitä tuotetta pistorasiaan, jos jännite ei ole sama.

Loukkaantumisen tai tuotteen vaurioitumisen vaara!

- Jos tuote kiinnitetään seinään, se on tehtävä seinäänkiinnitystä varten annettujen asennusohjeiden mukaisesti. Käytä ainoastaan tuotteen mukana toimitettua seinäkiinnikettä (jos käytettävissä). Väärin tehty seinäasennus voi aiheuttaa onnettomuuden, vamman tai vahingon. Jos sinulla on kysyttävää, ota yhteyttä oman maasi asiakastukeen.
- Älä koskaan aseta tuotetta tai muita esineitä virtajohtojen tai muiden elektronisten laitteiden päälle.
- Jos tuotetta kuljetetaan alle 5 °C:n lämpötilassa, poista tuote pakkauksesta ja anna sen lämmetä huoneenlämpöiseksi ennen sen liittämistä virtalähteeseen.
- Jotkin tämän tuotteen osat on voitu valmistaa lasista. Estä loukkaantuminen ja vahingot käsittelemällä tuotetta varovasti.

Ylikuumentumisen vaara!

- Älä koskaan asenna tuotetta ahtaaseen tilaan. Jätä tuotteen ympärille vähintään 10 cm tilaa, jotta ilma pääsee kiertämään. Varmista, että verhot tai muut esineet eivät peitä tuotteen ilmastointiaukkoja.

Saastumisen vaara!

- Älä sekoita vanhoja ja uusia tai hiili- ja alkalipohjaisia paristoja keskenään.
- Räjähdyksen vaara, jos paristot asetetaan paikalleen väärin. Vaihda vain samanlaiseen tai vastaavaan.
- Poista käytetyt paristot kaukosäätimestä. Poista paristot myös, jos tiedät, ettei kaukosäädintä käytetä pitkään aikaan.
- Paristot ovat ongelmajätettä: toimita käytetyt paristot asianmukaiseen keräyspisteeseen.

Paristot ovat nieltynä vaarallisia!

- Tuote/kaukosäädin saattaa sisältää nappipariston, jonka voi vahingossa niellä. Pidä paristot aina poissa lasten ulottuvilta! Nieltä paristo voi aiheuttaa vakavan vamman tai kuoleman. Pariston nieleminen

voi kahdessa tunnissa aiheuttaa vakavia sisäisiä palovammoja.

- Jos epäilet, että paristo on nieltä tai joutunut mihin tahansa ruumiin aukkoon, mene välittömästi lääkäriin.
- Kun vaihdat paristot, pidä aina kaikki uudet ja käytetyt paristot lasten ulottumattomissa. Varmista paristojen vaihtamisen jälkeen, että paristolokero menee kunnolla kiinni.
- Jos paristolokeroa ei saa kunnolla kiinni, lopeta tuotteen käyttäminen. Pidä tuote poissa lasten ulottuvilta ja ota yhteyttä valmistajaan.



Tämä on LUOKAN II laite, jossa on kaksoiseristys ja jossa ei ole maadoitusta.



Käytä ainoastaan käyttöoppaassa mainittuja virtalähteitä.

Tuotteen huolto

Puhdista laitetta vain mikrokuituliinalla.

Ympäristöstä huolehtiminen

Vanhan tuotteen sekä vanhojen akkujen ja paristojen hävittäminen



Tuotteen suunnittelussa ja valmistuksessa on käytetty laadukkaita materiaaleja ja osia, jotka voidaan kierrättää ja käyttää uudelleen.



Tämä merkki tarkoittaa, että tuote kuuluu Euroopan parlamentin ja neuvoston direktiivin 2012/19/EU soveltamisalaan.



Tämä kuvake tarkoittaa, että tuotteessa on akkuja tai paristoja, joita Euroopan parlamentin ja neuvoston direktiivi 2013/56/EU koskee. Niitä ei saa hävittää tavallisen kotitalousjätteen mukana.

Tutustu paikalliseen sähkö- ja elektroniikkalaitteiden keräysjärjestelmään. Noudata paikallisia säädöksiä äläkä hävitä tuotetta, paristoja tai akkuja tavallisen talousjätteen mukana. Vanhojen tuotteiden, paristojen ja akkujen asianmukainen hävittäminen auttaa ehkäisemään ympäristölle ja ihmisille mahdollisesti koituvia haittavaikutuksia.

Paristojen irrottaminen

Katso paristojen irrottamisohjeet kohdasta, jossa neuvotaan paristojen asettamisessa.

Vaatimustenmukaisuus

Tämä laite on Euroopan unionin radiohäiriöitä koskevien vaatimusten mukainen.

Gibson Innovations vakuuttaa täten, että tämä tuote on direktiivin 2014/53/EU oleellisten vaatimusten ja tuotetta koskevien direktiivin muiden säännösten mukainen. Vaatimustenmukaisuusvakuutus on osoitteessa www.p4c.philips.com.

Ohje ja tuki

Osoitteesta www.philips.com/support löydät laajan verkkotukemme ja voit

- ladata käyttöoppaan ja pikaoppaan
- katsoa video-oppaita (saatavilla vain tietyille malleille)
- etsiä vastauksia usein kysytyihin kysymyksiin (usein kysytyt kysymykset)
- lähettää meille kysymyksiä
- lähettää chat-viestejä Philipsin tukiedustajalle.

Valitse kieli noudattamalla sivuston ohjeita ja kirjoita sitten mallinumero.

Voit halutessasi pyytää tukea maasi kuluttajapalvelukeskuksesta. Ennen kuin otat yhteyttä kuluttajapalvelukeskukseen, kirjoita laitteen malli- ja sarjanumero muistiin. Tämä tieto on laitteen takapaneelissa tai pohjassa.

Avoimen lähdekoodin ohjelmisto

Tämä tuote sisältää avoimen lähdekoodin lisenssin perusteella lisensoidun ohjelmiston. Katso lähdemaininnat ja lisenssien tekstit tuotteen käyttöoppaasta osoitteessa www.philips.com/support.

Gibson Innovations Limited lupaa täten toimittaa pyydettyä kopiota tässä tuotteessa käytettyjen avoimen lähdekoodin ohjelmistopakettien lähdekoodista, mikäli tämä mahdollisuus mainitaan vastaavassa käyttöoikeussopimuksessa. Tämä tarjous on voimassa kolme vuotta tuotteen ostamisesta. Jos haluat lähdekoodin, kirjoita osoitteeseen open_source-gi@gibson.com. Jos et halua käyttää sähköpostia tai et saa vahvistusilmoitusta viikon kuluessa siitä, kun olet lähettänyt viestin tähän sähköpostiosoitteeseen, kirjoita seuraavaan osoitteeseen: Open Source Team, Gibson Innovations Limited, 5/F Philips Electronics Building, 5 Science Park East Avenue, Hong Kong Science Park, Shatin, N.T. Hongkong.

2 Tuote

Olet tehnyt erinomaisen valinnan ostaessasi Philipsin laitteen. Hyödynnä Philipsin tuki (esim. ilmoitus laitteiden ohjelmistopäivityksistä) ja rekisteröi laitteesi osoitteessa www.philips.com/welcome.

Päälaite

Tämä osa sisältää päälaitteen esittelyn.

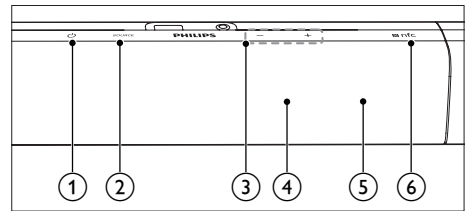

- ① **⏻**
 - Käynnistää laitteen.
 - Siirtää laitteen ECO-valmiustilaan, kun laite on liitettyä verkkoon.
 - Siirtää laitteen verkon valmiustilaan, kun laite ei ole liitettyä verkkoon.
- ② **SOURCE**
 - Voit valita laitteen äänitulolähteen.
 - Spotify Premium -käyttäjät voivat jatkaa nopeasti Spotify Connect -toistoa.
- ③ **Äänenvoimakkuus +/-**
Äänenvoimakkuuden lisääminen tai vähentäminen
- ④ **Punainen/valkoinen/oranssi merkkivalo**
Punainen merkkivalo
 - Syttyy, kun laite on ECO-valmiustilassa (ei liitettyä verkkoon).**Valkoinen LED**
 - Syttyy, kun laite on liitettyä verkkoon.
 - Syttyy, kun laite on verkon valmiustilassa (liitettyä verkkoon).
 - Vilkkuu, kun laite muodostaa verkkoyhteyttä.

Oranssi merkkivalo

- Syttyy, kun ohjelmistopäivitys on havaittu.

⑤ Näyttö

⑥ NFC-tunniste

Muodosta Bluetooth-yhteys napauttamalla tunnistetta NFC-yhteensopivalla laitteella.

Kaukosäädin

Tämä osa sisältää kaukosäätimen esittelyn.

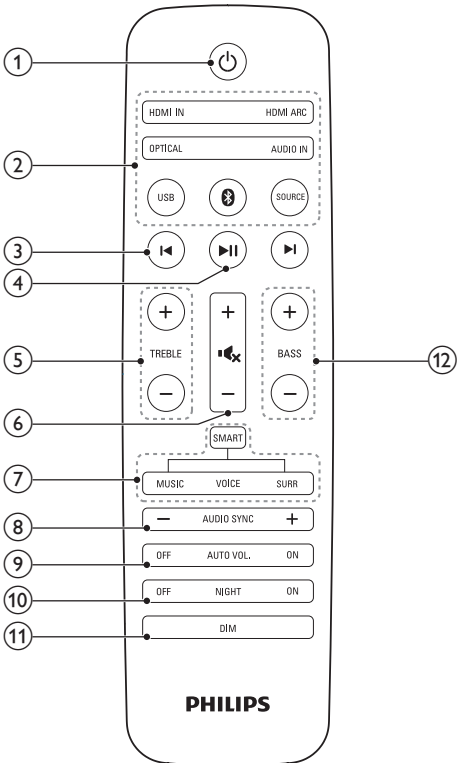

① (Valmiustila)

- Käynnistää laitteen.
- Siirtää laitteen ECO-valmiustilaan, kun laite on liitettyä verkkoon.
- Siirtää laitteen verkon valmiustilaan, kun laite ei ole liitettyä verkkoon.

② SOURCE-painikkeet

HDMI IN: vaihtaa lähteeksi HDMI IN -liitännän.

HDMI ARC: vaihtaa lähteeksi HDMI ARC -liitännän.

OPTICAL: Vaihda äänilähde optiseen liitännään.

AUDIO IN: vaihtaa äänilähteeksi MP3-liitännän (3,5 mm:n liitin).

USB: vaihtaa USB-tilaan.

ⓑ: vaihtaa Bluetooth-tilaan.

SOURCE: voit valita laitteen äänitulolähteen. Spotify Premium -käyttäjät voivat myös jatkaa nopeasti Spotify Connect -toistoa.

③ ◀ / ▶ (Edellinen/Seuraava)

Siirry edelliseen tai seuraavaan kappaleeseen.

④ ▶▶ (Toisto/Tauko)

Levyn toistamisen aloittaminen, keskeyttäminen ja jatkaminen.

⑤ TREBLE +/-

Lisää tai vähennä diskanttia.

⑥ Äänenvoimakkuuden säätö

- +/-: Äänenvoimakkuuden lisääminen tai vähentäminen
- **Ⓜ**: Mykistä tai palauta ääni.

⑦ Äänitilan hallinta

SMART: Valitse videolle tai musiikille sopiva esimääritetty äänitila.

MUSIC: Valitse stereoäänitila.

VOICE: Valitse puheen kirkkaus -äänitila.

SURR: Valitse surround-äänitila.

⑧ AUDIO SYNC +/-

Ääniviiveen lisääminen tai vähentäminen.

⑨ AUTO VOL ON/OFF

Automaattisen äänenvoimakkuuden ottaminen käyttöön / poistaminen käytöstä

⑩ NIGHT ON/OFF

Yötilan ottaminen käyttöön ja poistaminen käytöstä.

⑪ DIM

Laitteen näyttöpaneelin kirkkauden säätäminen.

- 12 BASS +/-
Lisää tai vähennä bassoa.

Liittimet

Tässä osiossa esitellään lyhyesti liitännät, jotka ovat käytettävissä tässä laitteessa.

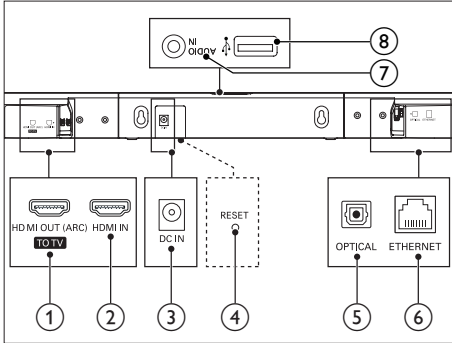

- 1 HDMI OUT (ARC) - TO TV
Television HDMI (ARC) -tuloliitäntä.
- 2 HDMI IN
Liitetään digitaalisen laitteen HDMI-lähtöliitäntään.
- 3 DC IN
Virtalähteen liitäntä.
- 4 RESET
Laitteen tehdasasetusten palautus painamalla nuppineulalla.
- 5 OPTICAL
Television tai digitaalisen laitteen optisen äänilähdön liitäntä.
- 6 ETHERNET
Laajakaistamodeemin tai -reitittimen Ethernet-tuloliitäntä.
- 7 AUDIO IN
Äänitulo esimerkiksi MP3-soittimesta (3,5 mm:n liitäntä).
- 8 •↔ (USB)

- USB-muistilaitteen liittäminen medialaitteiden äänentoistoon.
- Tuotteen ohjelmiston päivittäminen.
- USB-laitteen lataaminen.

Langaton subwoofer

Tämän tuotteen mukana tulee langaton subwoofer.

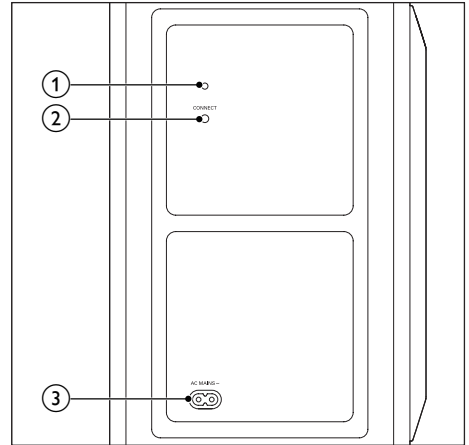

- 1 Subwooferin merkkivalo
 - Kun laitteessa on virta, merkkivalo palaa.
 - Subwooferin ja pääyksikön langattoman pariiliitoksen muodostuksen aikana merkkivalo vilkkuu valkoisena nopeasti.
 - Kun pariiliitos on valmis, merkkivalo palaa valkoisena.
 - Jos pariiliitos epäonnistuu, merkkivalo vilkkuu valkoisena hitaasti.
 - Jos langaton yhteys katkeaa minuutin ajaksi, merkkivalo sammuu.
- 2 CONNECT (liittäminen)
Siirry subwooferin pariiliitostilaan painamalla painiketta.
- 3 AC MAINS~
Virtalähteen liitäntä.

3 Liitännät

Tässä luvussa on ohjeita laitteen liittämistä television ja muihin laitteisiin. Pikaoppaassa on tietoja laitteen ja sen lisälaitteiden perusliitännöistä.

Huomautus

- Tunniste- ja tehotiedot on mainittu laitteen takana olevassa arvokilvessä.
- Varmista ennen liittäntöjen tekemistä, että kaikki laitteet on irrotettu virtalähteestä.

Verkon määrittäminen

Kun laite kytketään käyttöön ensimmäistä kertaa tai laite ei ole liitetty verkkoon, sinua kehoitetaan määrittämään verkko, jotta voit suoratoistaa musiikkia verkossa olevista musiikkisovelluksista.

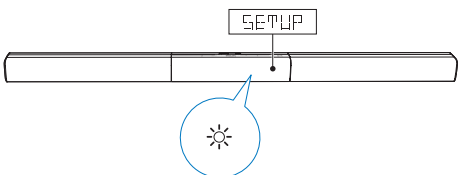

- ↳ Laitteen näyttöpaneelissa näkyy **SETUP** (määrittäminen).
- ↳ Laitteen valkoinen LED-merkkivalo vilkkuu.
- Katso lisätietoja verkkomäärittäksen alustamisesta kohdasta Sisäänrakennettu Chromecast ja Spotify Connect.
- Voit ohittaa verkon määrittämisen valitsemalla muun äänilähteen.

Sijoittaminen

Sijoita subwoofer vähintään 1 metrin päähän päälaitteesta ja 10 senttimetrin päähän seinästä. Saat parhaan tuloksen sijoittamalla subwooferin alla kuvatulla tavalla.

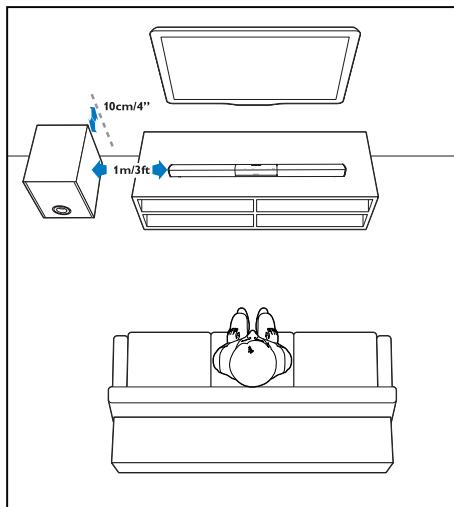

Pariliitoksen muodostaminen subwooferiin

Langaton pariliitos muodostetaan automaattisesti langattoman subwooferin ja pääyksikön välille, kun molempiin laitteisiin kytketään virta.

Pariliitos päälaitteeseen on muodostettava manuaalisesti seuraavissa tapauksissa.

- Päälaitteen ääni ei kuulu subwooferin kautta.
- Lähistöllä (10 m) on käytössä useampi kuin yksi **Philips HTL5160B** -sarja.

- 1 Kytke pääyksikön ja subwooferin virta.
 - ↳ Jos yhteys pääyksikköön katkeaa, subwooferin merkkivalo vilkkuu hitaasti valkoisena.

- 2 Siirry pariliitostilaan painamalla subwooferin **CONNECT** (liitäntä) -painiketta.
 - ↳ Subwooferin merkkivalo vilkkuu valkoisena nopeasti.
- 3 Paina HDMI ARC -tilassa (valitse kaukosäätimen **HDMI ARC**-painikkeella) kuuden sekunnin kuluessa **ARC** -painiketta kahdesti ja **Äänenvoimakkuus +**-painiketta kerran. Tämän jälkeen pidä **BASS +**-painiketta painettuna.
 - ↳ Jos pariliitos onnistuu, subwooferin merkkivalo palaa valkoisena.
 - ↳ Jos pariliitos epäonnistuu, subwooferin merkkivalo vilkkuu valkoisena hitaasti.
- 4 Jos pariliitos epäonnistuu, toista edellä olevat vaiheet.

Huomautus

- Jos langaton katkaisu tai pariliitoksen muodostaminen kestää 1 minuutin, subwoofer kytkeytyy automaattisesti valmiustilaan ja subwooferin LED-merkkivalo sammuu.

Televisio äänilähtöliitäntä

Liitä tämä laite TV:hen. Voit kuunnella TV-ohjelmien ääntä laitteen kaiuttimista.

1. vaihtoehto: TV:n liittäminen HDMI-liitäntään (ARC)

Laadukkaan äänen

Tämä tuote tukee HDMI-versiota, jossa on Audio Return Channel (ARC). ARC-ominaisuuden ansiosta voit kuunnella television ääntä tästä laitteesta käyttämällä yhtä HDMI-kaapelia.

Vaatimukset

- Nopea HDMI-kaapeli
- Televisio on sekä HDMI ARC- että HDMI-CEC-yhteensopiva (lisätietoja on television käyttöoppaassa).

- Joissakin TV-malleissa ulkoisen kaiuttimen lähtö otetaan käyttöön television asetusvalikosta (lisätietoja on television käyttöoppaassa).

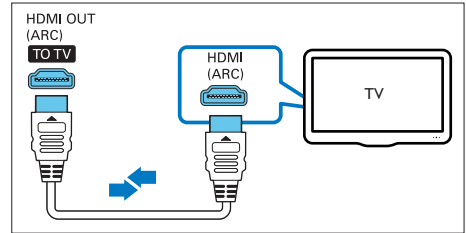

- 1 Jos käytät nopeaa HDMI-kaapelia, liitä se laitteen **HDMI OUT (ARC)**-liitäntään ja television **HDMI ARC**-liitäntään.
 - TV:n **HDMI ARC**-liittimessä voi olla toisenlainen merkintä. Lisätietoja on television käyttöoppaassa.
- 2 Ota HDMI-CEC-toiminnot käyttöön televisiossa.
 - Jos televisiossa on HDMI-CEC-toimintoihin liittyviä ongelmia, katso lisätietoja television käyttöoppaasta. Varmista myös, että HDMI-CEC-asetukset määritetty oikein. Ota tarvittaessa yhteyttä TV:n valmistajaan.
- 3 Ota laitteen HDMI ARC -liitäntä käyttöön painamalla kaukosäätimen **HDMI ARC**-painiketta.

Huomautus

- 100-prosenttista yhteensopivuutta kaikkien HDMI CEC -laitteiden kanssa ei taata.
- Jos TV ei ole HDMI ARC -yhteensopiva, liitä äänikaapeli, jos haluat kuunnella television ääntä laitteen kautta.

Vaihtoehto 2: liittäminen televisioon optisella kaapelilla

Laadukkain ääni

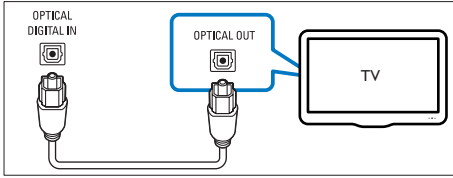

- 1 Liitä tämän laitteen **OPTICAL**-liitin TV:n optiseen lähtöliitintään optisen kaapelin avulla.
 - TV:n digitaalisessa optisessa lähdössä voi olla merkintä **OPTICAL OUT**, **SPDIF** tai **SPDIF OUT**.
- 2 Ota optinen liitintä käyttöön painamalla tämän laitteen kaukosäätimen **OPTICAL**-painiketta.

Vaihtoehto 3: liittäminen televisioon analogisilla äänikaapeleilla

Peruslaatuinen ääni

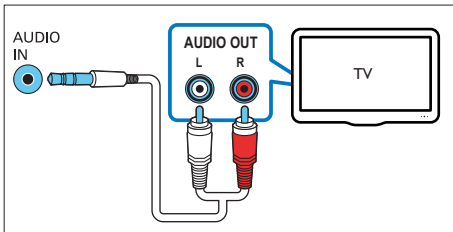

- 1 Aseta analoginen kaapeli tämän laitteen **AUDIO IN** -liitintään (3,5 mm) ja television analogiseen äänilähtöön (punainen ja valkoinen).
 - Ulkoisen laitteen analogisessa äänilähdössä voi olla merkintä **AUDIO OUT**.
- 2 Ota laitteen analoginen ääniliitintä käyttöön painamalla kaukosäätimen **AUDIO IN**-painiketta.

Äänen liittäminen muista laitteista

Tämän laitteen kaiuttimilla voit toistaa ääntä myös muista laitteista.

Vaihtoehto 1: liittäminen muuhun laitteeseen optisella kaapelilla

Laadukkain ääni

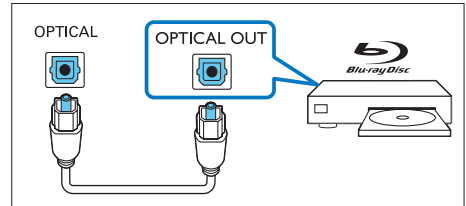

- 1 Liitä tämän laitteen **OPTICAL**-liitin ulkoisen laitteen optiseen lähtöliitintään optisen kaapelin avulla.
 - Ulkoisen laitteen digitaalisessa optisessa lähdössä voi olla merkintä **OPTICAL OUT**, **SPDIF** tai **SPDIF OUT**.
- 2 Ota optinen liitintä käyttöön painamalla tämän laitteen kaukosäätimen **OPTICAL**-painiketta.

Vaihtoehto 2: liittäminen muuhun laitteeseen analogisilla äänikaapeleilla

Peruslaatuinen ääni

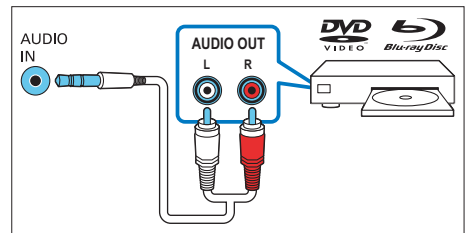

- 1 Aseta analoginen kaapeli tämän laitteen **AUDIO IN** -liitäntään (3,5 mm) ja ulkoisen laitteen analogiseen äänilähtöön (punainen ja valkoinen).
 - Ulkoisen laitteen analogisessa äänilähdössä voi olla merkintä **AUDIO OUT**.
- 2 Ota laitteen analoginen ääniliitäntä käyttöön painamalla kaukosäätimen **AUDIO IN**-painiketta.

Digitaalisten laitteiden liittäminen HDMI-liitäntään

Liitä digitaalilaitte, kuten digisovitin, DVD-/Blu-ray-soitin tai pelikonsoli, laitteeseen yhden HDMI-liitännän kautta. Jos laite on liitetty tällä tavoin ja toistat tiedostoa tai peliä,

- video näytetään automaattisesti televisiossa ja
- ääni toistetaan automaattisesti tällä laitteella.

- 1 Liitä nopea HDMI-kaapeli digitaalisen laitteen **HDMI OUT** -liitäntään ja laitteen **HDMI IN** -liitäntään.
- 2 Jos käytät nopeaa HDMI-kaapelia, liitä se laitteen **HDMI OUT (ARC)**-liitäntään ja television **HDMI**-liitäntään.
 - Ota HDMI-CEC-ohjaus (jos käytettävissä) käyttöön televisiossa ja liitetyssä laitteessa. Lisätietoja on television ja laitteen käyttöoppaissa.
- 3 Ota laitteen HDMI IN -liitäntä käyttöön painamalla kaukosäätimen **HDMI IN**-painiketta.
 - Jos TV ei ole HDMI CEC -yhteensopiva, valitse oikea TV:n videotulo.

4 Sisäänrakennettu Chromecast ja Spotify Connect

Tämän laitteen kaiuttimista voit kuunnella musiikkia seuraavista verkossa olevista musiikkipalveluista.

- Chromecast -yhteensopivat sovellukset
- Spotify Connect

Vaatimukset

- Älypuhelin/tablet-laite, jossa on Android 4.3 tai uudempi; iPhone/iPad, jossa on iOS 8.0 tai uudempi
- Google Playsta tai iOS App Storesta ladattu Philips **HCWeSet** -sovellus
- Verkkoreititin
- Verkkokaapeli (jos käytät kiinteää yhteyttä).

Laitteen liittäminen verkkoon

Jos haluat käyttää sisäänrakennettu Chromecast- ja Spotify Connect -palveluita, tämä laite on liitettävä verkkoon. Tätä ennen verkko on määritettävä.

Ennen aloittamista

- Varmista, että tämä laite ja mobiililaitte ovat liitettyinä samaan verkkoon.
- Kiinteä verkko: liitä verkkokaapeli laitteen **LAN**-liitäntään ja verkkoreitittimeen.
- Langaton verkko: laitteessa on kiinteä Wi-Fi-yhteys.

- 1 Käynnistä Philips HCWeSet -sovellus mobiililaitteessasi.
- 2 Suorita asennus noudattamalla näytössä näkyviä ohjeita.
 - Käynnistä asennustoiminto ensiasennussivulla valitsemalla Setup New Speaker (Valitse uusi kaiutin).
 - **iOS- käyttäjät:** valitse pyydettyäessä tämä laite iOS-laitteen Wi-Fi-

luettelosta. Palaa sitten sovellukseen ja jatka verkon määrittämistä.

- Kun tämä laite muodostaa verkkoyhteyttä, laitteen valkoinen LED-merkkivalo vilkkuu.
- Kun laite on liitettyä verkkoon, laitteen valkoinen LED-merkkivalo syttyy.

Huomaus

- Verkkomäärityksen aikana ota Chromecast -yhteensopivat sovellukset käyttöön hyväksymällä Googlen palveluehdot ja tietosuojakäytännöt.
- Jos verkkoon yhdistäminen ei onnistu verkkomäärityksen aikana, yritä uudelleen noudattamalla näytössä annettuja ohjeita.

Musiikin suoratoisto laitteessa

Verkon määrittämisen jälkeen voit suoratoistaa musiikkia verkosta sisäänrakennettu Chromecast- ja Spotify Connect -palveluiden avulla.

- 1 Käynnistä Philips HCWeSet -sovellus mobiililaitteessasi.
- 2 Siirry sovelluksen aloitussivulle.
↳ Chromecast -yhteensopivat sovellukset ja Spotify näkyvät aloitussivulla.
- 3 Aloita musiikin suoratoisto napauttamalla musiikkipalvelun kuvaketta.
 - Jos musiikkisovellus on jo asennettu mobiililaitteeseen, sovellus käynnistetään.
 - Jos musiikkisovellusta ei ole asennettu mobiililaitteeseen, sovellus asennetaan siirtymällä Google Playhin tai iOS App Storeen.
 - Katso lisätietoja sisäänrakennettu Chromecast- ja Spotify Connect -palveluiden käytöstä kohdasta Navigate the App home menu (Sovelluksen aloitusvalikon selaaminen).
↳ Mobiililaitteella toistettu musiikki suoratoistetaan tähän laitteeseen.

Huomaus

- Verkon asennuksen jälkeen voit halutessasi käynnistää suoraan Chromecast -yhteensopivat sovellukset (kuten Google Play Music, Tunes Radio jne.) tai Spotify-sovelluksen ja suoratoistaa musiikkia tällä laitteella.
- Jotta voit käyttää Spotify Connect -palvelua, sinun on oltava Spotify Premium -käyttäjä.
- Kun ohjelmistopäivitys on havaittu, laitteen oranssi LED-merkkivalo syttyy.

Sovelluksen aloitusvalikon selaaminen

- 1 Käynnistä Philips HCWeSet -sovellus mobiililaitteessasi.
- 2 Siirry sovelluksen aloitussivulle.
- 3 Napauttamalla  -kuvaketta saat näkyviin valikon, jossa voit tehdä seuraavat toimet:
 - My Speakers (Omat kaiuttimet) -kohdassa voit mm. päivittää laitteen ohjelmiston ja palauttaa laitteen oletusasetukset
 - tutustua sisäänrakennettu Chromecast -palvelun käyttöön
 - tutustua Spotify Connect -palvelun käyttöön
 - katsoa lainopilliset tiedot ja ilmoitukset.
 - katsoa asiakastukitiedot.

5 Tuotteen käyttäminen

Tässä osiossa kerrotaan, miten laitteella voi toistaa mediaa useista eri lähteistä.

Ennen aloittamista

- Tee tarvittavat liitännät pikaoppaan ohjeiden mukaan tai lataa käyttöopas osoitteesta www.philips.com/support.
- Valitse tässä laitteessa muiden laitteiden oikea lähde.

Säädä äänenvoimakkuutta

- 1 Lisää tai vähennä äänenvoimakkuutta **Äänenvoimakkuus +/-** -painikkeella.
 - Mykistä **M** -painikkeella.
 - Palauta ääni painamalla **M** -painiketta uudelleen tai **Äänenvoimakkuus +/-** -painikkeella.

Äänen valinta

Tässä luvussa kerrotaan, miten valitaan paras ääni videolle tai musiikille.

Äänitila

Valitse videolle tai musiikille sopiva esimääritetty äänitila.

- Ota käyttöön surround-äänitila painamalla **SURR**-painiketta. Soveltuu elokuvien katseluun.
- Ota käyttöön kahden tai useamman kanavan steroäänitila painamalla **MUSIC**-painiketta. Soveltuu musiikin kuunteluun.
- Tee puheesta selkeämpää valitsemalla **VOICE**.
- Valitse esimääritetty äänitila (**SURR**, **MUSIC** tai **VOICE**) automaattisesti sisällön mukaan valitsemalla **SMART**.

Taajuuskorjain

Säädä tämän laitteen korkean taajuuden (diskantti) ja matalan taajuuden (basso) asetuksia.

- 1 Vaihda taajuutta painamalla **TREBLE +/-** tai **BASS +/-**-painiketta.

Kuvan ja äänen tahdistaminen

Jos ääntä ja videota ei ole tahdistettu, viivytä ääntä siten, että se on samassa tahdissa kuvan kanssa.

- 1 Synkronoi ääni videon kanssa **AUDIO SYNC +/-**-painikkeella.
 - **AUDIO SYNC +** lisää äänen viivettä ja **AUDIO SYNC -** vähentää viivettä.

Automaattinen äänenvoimakkuus

Ota automaattinen äänenvoimakkuus käyttöön, kun haluat pitää äänenvoimakkuuden muuttumattomana vaihtaessasi äänilähdettä tai TV-kanavaa.

- 1 Ota automaattinen äänenvoimakkuus käyttöön tai poista se käytöstä **AUTO VOL ON/OFF**-painikkeella.

Night mode

Night mode (yökuuntelu) vähentää kovien äänten äänenvoimakkuutta toiston aikana. Yökuuntelua voi käyttää vain Dolby Digital -äänelle.

- 1 Ota yökuuntelu käyttöön tai poista se käytöstä **NIGHT ON/OFF**-painikkeella.

Huomaus

- Jos automaattinen äänenvoimakkuus on otettu käyttöön, et voi ottaa käyttöön yötilaa.

Äänen toistaminen Bluetoothin kautta

Liittämällä tämän laitteen Bluetooth-laitteeseen (kuten iPad, iPhone, iPod touch, Android-puhelin tai kannettava tietokone) Bluetooth-yhteyden välityksellä voi kuunnella laitteeseen tallennettuja äänitiedostoja tämän laitteen kaiuttimien kautta.

Vaativuudet

- Bluetooth-laite, joka tukee seuraavia:
 - Bluetooth-profiilit: A2DP, AVRCP
 - Bluetooth-versio: Bluetooth 4.1, jossa Bluetooth Low Energy
- Pääyksikön ja Bluetooth-laitteen välinen toiminta-alue on enintään noin 10 metriä.

- 1 Siirrä tämä laite Bluetooth-tilaan kaukosäätimen painikkeella .
↳ **BT** vilkkuu näyttöpaneelissa.
- 2 Ota Bluetooth käyttöön Bluetooth-laitteessa ja aloita yhteyden muodostus hakemalla ja valitsemalla **Philips HTLS160** (katso Bluetooth-laitteen käyttöoppaasta ohjeita Bluetoothin käyttöönottamiseen).
↳ Yhteyttä muodostettaessa **BT** vilkkuu näyttöpaneelissa.
- 3 Odota, kunnes laite antaa äänimerkin.
↳ Kun Bluetooth-yhteys on muodostettu, **BT** näkyy näyttöpaneelissa.
↳ Jos yhteyden muodostaminen epäonnistuu, **BT** vilkkuu näyttöpaneelissa.
- 4 Valitse ja toista äänitiedostoja tai musiikkia Bluetooth-laitteessa.
 - Jos puhelu saapuu toiston aikana, musiikin toisto keskeytetään. Toisto jatkuu, kun puhelu päättyy (tämän ominaisuuden toiminta riippuu liitetystä matkapuhelimesta).
 - Jos Bluetooth-laite tukee AVRCP-profiilia, voit ohittaa kappaleen painamalla kaukosäätimen **◀ / ▶** -painiketta tai keskeyttää toiston / jatkaa toistoa painamalla **▶||** -painiketta.

- 5 Poistu Bluetooth-tilasta valitsemalla toinen lähde.
 - Kun siirryt takaisin Bluetooth-tilaan, Bluetooth-yhteys on edelleen käytössä.

Huomautus

- Laitteiden välissä olevat esteet, kuten seinät, laitteen metallikotelo tai muut lähellä olevat samaa taajuutta käyttävät laitteet, saattavat häiritä musiikin suoratoistoa.
- Jos haluat liittää laitteen toiseen Bluetooth-laitteeseen, katkaise yhteys nykyiseen Bluetooth-laitteeseen pitämällä alhaalla kaukosäätimen painiketta .

Bluetooth-yhteyden muodostaminen NFC:n kautta

NFC (Near Field Communication) on tekniikka, joka mahdollistaa lyhyen kantaman langattoman yhteyden NFC-yhteensopivien laitteiden, kuten matkapuhelinten, välillä.

Vaativuudet

- Bluetooth-laite, jossa on NFC-toiminto.
 - Muodosta yhteys napauttamalla NFC-laitteella tämän laitteen **NFC**-tunnistetta.
- 1 Bluetooth-laitteen NFC-toiminnon käyttöönotto (katso lisätietoja laitteen käyttöoppaasta).
 - 2 Kosketa NFC-laitteella tämän laitteen **NFC**-tunnistetta, kunnes laite antaa äänimerkin.
 - Jos mobiililaite kysyy ensimmäisellä yhteykserralla, haluatko luoda pariliitoksen, valitse Kyllä.
 - ↳ Kun Bluetooth-yhteys on muodostettu, **BT** näkyy näyttöpaneelissa.
 - ↳ Jos yhteyden muodostaminen epäonnistuu, **BT** vilkkuu näyttöpaneelissa.
 - 3 Valitse ja toista äänitiedostoja tai musiikkia NFC-laitteesta.
 - Katkaise yhteys koskettamalla NFC-laitteella uudelleen tämän laitteen **NFC**-tunnistetta.

MP3-soitin

Liitä MP3-soittimesi ja toista äänitiedostoja tai musiikkia.

Vaatimukset

- MP3-soitin.
- 3,5 mm:n stereoäänikaapeli.

- 1 Liitä MP3-soitin laitteen **AUDIO IN**-liitäntään 3,5 mm:n stereoäänikaapelilla.
- 2 Paina **AUDIO IN** kaukosäätimessä.
- 3 Valitse toistettavat äänitiedostot tai musiikki ja aloita toisto MP3-soittimen painikkeilla.

USB-muistilaitteet

Kuuntele ääntä USB-muistilaitteesta, kuten MP3-soittimesta ja USB Flash -muistista.

Vaatimukset

- USB-muistilaitte, joka on FAT- tai NTFS-alustettu ja joka on yhteensopiva Mass Storage Class -luokan kanssa.

- 1 USB-muistilaitteen liittäminen tähän laitteeseen
- 2 Paina **USB** kaukosäätimessä.
- 3 Toistoa hallitaan kaukosäätimellä.
 - Aloita ja keskeytä toisto tai jatka sitä painamalla painiketta **▶||**.
 - Siirry edelliseen tai seuraavaan raitaan painamalla painiketta **◀|▶**.
 - Siirry toistotilaan USB-toiston aikana pitämällä painiketta **USB** painettuna. Paina sitten painiketta **USB**, niin voit valita jonkin seuraavista toistotiloista.
 - **RPT-TRACK**: nykyisen raidan uusintatoisto.
 - **RPT-ALL**: kansion kaikkien raitojen uusintatoisto.
 - **RPT-RAND**: kansion raitojen toisto satunnaisessa järjestyksessä.
 - **RPT-OFF**: poistuminen uusinta- tai satunnaistoistotilasta.

Huomautus

- Tämä tuote ei ole välttämättä yhteensopiva tietyn tyyppisten USB-tallennuslaitteen kanssa.
- Jos käytät USB-jatkokaapelia, USB-keskitintä tai useiden USB-muistikorttien lukijaa, USB-muistilaitetta ei ehkä voida tunnistaa.
- Digikameroiden PTP- ja MTP-protokolla ei tueta.
- Älä irrota USB-tallennuslaitetta, kun sitä luetaan.
- DRM-suojattuja musiikkitiedostoja (MP3) ei tueta.
- Tuettu USB-portti: 5 V $\overline{\text{---}}$, 1 A.

Automaattinen valmiustila

Verkon valmiustila

Kun laite on liitettyä verkkoon, laite siirtyy automaattisesti verkon valmiustilaan, kun sitä ei ole käytetty 15 minuuttiin. Verkon valmiustila on toiminto, joka optimoi musiikin suoratoistoa mobiilisovelluksista lyhentämällä laitteen käynnistymisaikaa valmiustilasta.

ECO-valmiustila

Kun laite ei ole liitettyä verkkoon, laite siirtyy automaattisesti ECO-valmiustilaan, kun sitä ei ole käytetty 15 minuuttiin. ECO-valmiustila lyhentää laitteen käynnistymisaikaa valmiustilasta ja vähentää samalla virrankulutusta.

Huomautus

- Jos laite on ECO-valmiustilassa, punainen LED-merkkivalo syttyy.
- Jos laite on verkon valmiustilassa, valkoinen LED-merkkivalo syttyy ja punainen LED-merkkivalo sammuu.

Näytön kirkkouden säätäminen

Säädä näytön kirkkautta painamalla **DIM**-painiketta toistuvasti.

Jos valitset **AUTO OFF**, LED-viesti katkaistaan, jos painiketta ei paineta 10 sekuntiin.

Ota tehdasasetukset käyttöön

Jos laite ei vastaa tuotteen tai verkon määrittämisessä on ongelma, voit palauttaa laitteen tehtaalla ohjelmoidut oletusasetukset.

Huomautus

- Kun tehdasasetukset on palautettu, laite sammuu ja käynnistyy uudelleen automaattisesti.

Vaihtoehto 1:

- 1 Käynnistä Philips HCWeSet -sovellus mobiililaitteessasi.
 - Varmista, että laite on liitettyä verkkoon.
- 2 Siirry sovelluksen aloitussivulle.
- 3 Avaa asetusvalikko napauttamalla  -kuvaketta.
- 4 Valitse My Speakers (Omat kaiuttimet).
↳ Liitetyt laitteet näkyvät luettelossa.
- 5 Valitse sitten Factory Reset (Tehdasasetukset) ja seuraa näytön ohjeita.

Vaihtoehto 2:

- 1 Voit palauttaa laitteen oletusasetukset painamalla laitteen pohjassa olevaa **RESET**-kohtaa nuppineulalla.

Vaihtoehto 3:

- 1 Paina HDMI ARC -tilassa (paina **HDMI ARC** -painiketta) kahdesti  -painiketta ja sitten kerran **Äänenoimakkuus** -painiketta. Pidä tämän jälkeen **BASS** -painiketta painettuna.

6 Ohjelmiston päivittäminen

Saat parhaat ominaisuudet ja tuen, kun päivität laitteeseen uusimman ohjelmiston.

Ohjelmistoversion tarkistaminen

- 1 Käynnistä Philips HCWeSet -sovellus mobiililaitteessasi.
 - Varmista, että laite on liitettyä verkkoon.
- 2 Siirry sovelluksen aloitussivulle.
- 3 Avaa asetusvalikko napauttamalla  -kuvaketta.
- 4 Valitse My Speakers (Omat kaiuttimet).
↳ Liitetyt laitteet näkyvät luettelossa.
- 5 Valitse About (Tietoja).
↳ Näkyviin tulee ohjelmistoversion numero ja muita tuotetietoja.

Huomautus

- Kun ohjelmistopäivitys on havaittu laitteen ollessa liitettyä verkkoon, laitteen oranssi LED-merkkivalo syttyy.
- Päivitys voi kestää noin 3 minuuttia.

Ohjelmiston päivittäminen internetin kautta

- 1 Käynnistä Philips HCWeSet -sovellus mobiililaitteessasi.
 - Varmista, että laite on liitettyä verkkoon.
- 2 Siirry sovelluksen aloitussivulle.

- 3 Avaa asetusvalikko napauttamalla ☰
-kuvaketta.
- 4 Valitse My Speakers (Omat kaiuttimet).
↳ Liitetyt laitteet näkyvät luettelossa.
- 5 Valitse tämän laitteen nimi ja valitse sitten Software Update (Ohjelmistopäivitys) > Network (Verkko).
- 6 Suorita päivitykset näytön ohjeiden mukaisesti.
↳ Päivityksen aikana näyttöpaneelissa näkyy UPG (päivitys).
↳ Jos päivitys on valmis, laite sammuu ja käynnistyy uudelleen automaattisesti.
↳ Jos päivitys epäonnistuu, näyttöpaneelissa näkyy FAIL (virhe).

Ohjelmistopäivitys USB-yhteyden kautta

Vaatimukset

- USB-muistilaitte, joka on FAT16-, FAT32- tai NTFS-alustettu.

- 1 Hae uusin ohjelmistoversio osoitteesta www.philips.com/support
 - Hae laitteesi malli ja napsauta kohtaa Ohjelmistot ja ohjaimet.
- 2 Lataa ohjelmisto USB-laitteeseen.
 - ① Pura ladattu tiedosto ja varmista, että puretun kansion nimi on UPG.
 - ② Siirrä UPG-tiedosto ylätasoin hakemistoon.
- 3 Liitä USB-tallennuslaite tuotteen  (USB)
-liitäntään.
- 4 Käynnistä Philips HCWeSet -sovellus mobiililaitteessasi.
 - Varmista, että laite on liitettyä verkkoon.
- 5 Siirry sovelluksen aloitussivulle.
- 6 Avaa asetusvalikko napauttamalla ☰
-kuvaketta.

- 7 Valitse My Speakers (Omat kaiuttimet).
↳ Liitetyt laitteet näkyvät luettelossa.
- 8 Valitse tämän laitteen nimi ja valitse sitten Software Update (Ohjelmistopäivitys) > USB.
- 9 Suorita päivitykset näytön ohjeiden mukaisesti.
↳ Päivityksen aikana näyttöpaneelissa näkyy UPG (päivitys).
↳ Jos päivitys on valmis, laite sammuu ja käynnistyy uudelleen automaattisesti.
↳ Jos päivitys epäonnistuu, näyttöpaneelissa näkyy FAIL (virhe).

Varoitus

- Älä katkaise laitteen virtaa tai irrota USB-massamuistilaitetta kesken ohjelmistopäivityksen. Soitin voi vahingoittua.

7 Seinäteline

Huomautus

- Varmista ennen kiinnittämistä seinälle, että seinä kestää laitteen painon.
- Jos tuote kiinnitetään seinään, se on tehtävä seinäänkiinnitystä varten annettujen asennusohjeiden mukaisesti. Väärin tehty seinäasennus voi aiheuttaa onnettomuuden, vammian tai vahingon. Jos sinulla on kysyttävää, ota yhteyttä oman maasi asiakastukeen.

Ruuvien pituus/halkaisija

Varmista, että käytät tuotteen seinäkiinnityksen mukaan sopivan pituisia ja halkaisijaltaan sopivan kokoisia ruuveja.

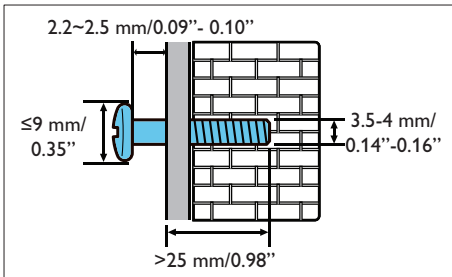

Kiinnitä tuote seinään pikaoppaan kuvien mukaisesti.

- 1) Merkitse kahden ruuvien paikat seinään mukana toimitetun paperimallin avulla. Ruuvaa vaadittunlaiset ruuvit merkittyihin kohtiin.
- 2) Kiinnitä tuotteen mukana toimitetut seinätelineet.
- 3) Ripusta tuote seinälle.

8 Tuotetiedot

Huomautus

- Muotoilu ja tiedot voivat muuttua ilman erillistä ilmoitusta.

Vahvistin

- Kokonaisteho: 320 W RMS (+/- 0,5 dB, 10 % THD)
- Taajuusvaste: 20 Hz–20 kHz / +/- 3 dB
- Signaali/kohina-suhde: >65 dB (CCIR) / (A-painotettu)
- Tuloherkkyys:
 - ÄÄNITULO: 1 V

Ääni

- Digitaalinen S/PDIF-äänitulo:
 - Optinen: TOSLINK

USB

- Yhteensopivuus: Hi-Speed USB (2.0)
- Luokat: USB Mass Storage Class (MSC)
- Tiedostojärjestelmä: FAT16, FAT32, NTFS

Tiedostomuodot

- .aac, .mka, .mp3, .wav, .m4a, .flac, .ogg, .ape, .dsf, .dff

WLAN

- Taajuuskaista/lähtöteho:
 - 2412–2472 MHz (Eurooppa) / ≤ 20 dBm
 - 2412–2462 MHz (Yhdysvallat ja Aasia) / ≤ 20 dBm
 - 5180–5240 MHz (maailmanlaajuinen) / ≤ 14 dBm
 - 5745–5825 MHz (Yhdysvallat ja Aasia) / ≤ 14 dBm
- Euroopassa taajuuskaista 5150–5350 MHz on varattu vain sisäkäyttöön.
- Tuetut langattomat standardit: IEEE802.11 a/b/g/n

- Tuetut kanavat:
 - **2,4 GHz:** 1–13 (Eurooppa) tai 1–11 (USA ja Aasia)
 - **5,X GHz:** 36, 40, 44, 48 (maailmanlaajuinen) ja 149, 153, 157, 161, 165 (USA ja Aasia)

Bluetooth

- Bluetooth-profiilit: A2DP, AVRCP
- Bluetooth-versio: Bluetooth 4.1, jossa Bluetooth Low Energy
- Taajuuskaista/lähtöteho: 2400–2483,5 MHz / ≤ 20 dBm
- NFC-taajuus: 13,56 MHz

Langaton kaiutinlinkki

- Taajuuskaista: 5730–5845 MHz
- Lähtöteho: ≤ 14 dBm

Päälaite

- Virtalähde:
 - Malli (Philips-verkkolaite): TNUA3202003
 - Tulo: 100–240 V~, 50/60 Hz, 1,65 A
 - Lähtö: 32 V \equiv , 2,0 A
- Virrankulutus valmiustilassa
 - ECO-valmiustila: $\leq 0,5$ W
 - Verkon valmiustila: < 6 W
- Mitat (L x K x S): 1100 x 51 x 69 mm
- Paino: 2,2 kg
- **Kiinteät kaiuttimet**
 - Vasen/oikea kanava: 4 x bassokaiutin (90 mm / 3,5" x 34 mm / 1,3", 6 ohmia) + 2 x diskanttikaiutin (25,4 mm / 1", 4 ohmia)
 - Keskikanava: 1 x bassokaiutin (90 mm / 3,5" x 34 mm / 1,3", 3 ohmia) + 1 x diskanttikaiutin (25,4 mm / 1", 4 ohmia)
- Käyttölämpötila ja -ilmankosteus: 0–45 °C, 5–90 %:n ilmankosteus kaikille ilmastoille
- Säilytyslämpötila ja -ilmankosteus: -40–70 °C, 5–95 %

Subwoofer

- Virtalähde: 220–240 V~, 50–60 Hz
- Virrankulutus: 30 W
- Virrankulutus valmiustilassa: $\leq 0,5$ W
- Impedanssi: 2 ohmia
- Kaiutinelementit: 1 x 203 mm:n (8") bassokaiutin
- Mitat (L x K x S): 205 x 316 x 401 mm
- Paino: 7,0 kg

Kaukosäätimen paristot

- 2 x AAA-R03, 1,5 V

Valmiustilan virranhallinta

- Jos laitetta ei käytetä 15 minuuttiin, se siirtyy automaattisesti valmiustilaan tai verkon valmiustilaan.
- Katkaise Bluetooth-yhteys pitämällä kaukosäätimen Bluetooth-painiketta painettuna.
- Muodosta Bluetooth-yhteys ottamalla Bluetooth-yhteys käyttöön Bluetooth-laitteessasi tai ottamalla Bluetooth-yhteys käyttöön NFC-tunnisteen kautta (jos käytettävissä).

9 Vianmääritys



Vakava varoitus

- Sähköiskun vaara. Älä koskaan avaa tuotteen runkoa.

Älä yritä korjata tuotetta itse, jotta takuu ei mitätöidy.

Jos sinulla on ongelmia laitteen käytön kanssa, tarkista seuraavat seikat, ennen kuin otat yhteyden huoltoon. Jos ongelma ei ratkea, saat tukea osoitteessa www.philips.com/support.

Päälaite

Laitteen painikkeet eivät toimi.

- Irrota laitteen virtajohto pistorasiasta muutamaksi minuutiksi ja liitä se sitten uudelleen.

Ääni

Laitteen kaiuttimista ei kuulu ääntä.

- Liitä tämän laitteen äänikaapeli televisioon tai muihin laitteisiin.
- Varmista, että laitteen äänitulo on liitetty TV:n tai muun laitteen äänilähtöön.
- Laitteen tehdasetusten palauttaminen.
- Valitse oikea äänitulo kaukosäätimellä.
- Varmista, ettei tämä laite ole mykistetty.

Vääristynyt ääni tai kaiku.

- Jos toistat TV:n ääntä tämän laitteen kautta, varmista, että TV on mykistetty.

Ääni ja video eivät ole synkronoitu.

- Synkronoi ääni videon kanssa **AUDIO SYNC +/-**-painikkeella.

Näyttöpaneelissa näkyy virheilmoitus.

- Jos näytössä näkyy ERROR-virheilmoitus, äänitulon muotoa ei tueta.
- Jos näytössä vilkkuu ARC-teksti, liitetty televisio ei ole HDMI ARC -yhteensopiva tai äänimuotoa ei tueta.

Bluetooth

Toinen laite ei voi muodostaa yhteyttä tähän laitteeseen.

- Laite ei tue tämän laitteen edellyttämiä yhteensopivia profiileja.
- Laitteen Bluetooth-toimintoa ei ole otettu käyttöön. Katso toiminnon käyttöönottamista koskevat ohjeet laitteen käyttöoppaasta.
- Laitetta ei ole liitetty oikein. Liitä laite oikein.
- Laitteeseen on jo liitetty toinen Bluetooth-laite. Katkaise liitetyn laitteen yhteys ja yritä uudelleen.

Äänentoiston laatu liitetystä Bluetooth-laitteesta on heikko.

- Bluetooth-yhteys on heikko. Siirrä laite lähemmäs tätä laitetta tai poista laitteiden välissä olevat esteet.

Liitetty Bluetooth-laite muodostaa ja katkaisee yhteyden jatkuvasti.

- Bluetooth-yhteys on heikko. Siirrä laite lähemmäs tätä laitetta tai poista laitteiden välissä olevat esteet.
- Poista Bluetooth-laitteen Wi-Fi-toiminto käytöstä häiriöiden välttämiseksi.
- Joissakin Bluetooth-laitteissa Bluetooth-yhteys katkaistaan automaattisesti virran säästämiseksi. Tämä ei ole laitteesta johtuva vika.

NFC

Toinen laite ei voi muodostaa yhteyttä tähän laitteeseen NFC:n kautta.

- Varmista, että laite on NFC-yhteensopiva.
- Varmista, että NFC on otettu käyttöön laitteessa (katso lisätietoja käyttöoppaasta).
- Muodosta yhteys napauttamalla NFC-laitteella tämän laitteen NFC-tunnistetta.

Internet-palvelut

Laitteella ei voi suoratoistaa musiikkia sisäänrakennettu Chromecast- tai Spotify Connect -palveluista.

- Laite ei ole liitettyä verkkoon. Suorita ensiasennus, jos asennusta ei ole viety loppuun.

Laitetta ei voi liittää verkkoon.

- Varmista, etteivät mikroaaltouunit, DECT-puhelimet tai lähellä olevat Wi-Fi-laitteet häiritse langatonta verkkoa.
- Aseta langaton reititin ja tämä laite enintään viiden metrin etäisyydelle toisistaan.
- Varmista, että tämä laite ja mobiililaitte ovat liitettyä samaan verkkoon.
- Laitteen tehdasasetusten palauttaminen.



Manufactured under license from Dolby Laboratories. Dolby, Pro Logic, and the double-D symbol are trademarks of Dolby Laboratories.



Manufactured under license from Dolby Laboratories. Dolby and the double-D symbol are trademarks of Dolby Laboratories.



The terms HDMI and HDMI High-Definition Multimedia Interface, and the HDMI Logo are trademarks or registered trademarks of HDMI Licensing LLC in the United States and other countries.



The Bluetooth® word mark and logos are registered trademarks owned by Bluetooth SIG, Inc. and any use of such marks by Gibson Innovations Limited is under license. Other trademarks and trade names are those of their respective owners.



The N Mark is a trademark or registered trademark of NFC Forum, Inc. in the United States and in other countries.



Chromecast is a trademark of Google Inc.



The Spotify Software is subject to third party licenses found here: www.spotify.com/connect/third-party-licenses.

License Texts and Acknowledgements for any open source software used in this Philips product

Instructions to obtain source code for this software can be found in the user manual, or in the supplied safety leaflet (if available).

1. U-boot

```
#
# (C) Copyright 2000 - 2009
# Wolfgang Denk, DENX Software Engineering, wd@denx.de.
#
# See file CREDITS for list of people who contributed to this
# project.
#
# This program is free software; you can redistribute it and/or
# modify it under the terms of the GNU General Public License as
# published by the Free Software Foundation; either version 2 of
# the License, or (at your option) any later version.
#
# This program is distributed in the hope that it will be useful,
# but WITHOUT ANY WARRANTY; without even the implied
# warranty of MERCHANTABILITY or FITNESS FOR A
# PARTICULAR PURPOSE. See the GNU General Public License for
# more details.
#
# You should have received a copy of the GNU General Public
# License along with this program; if not, write to the Free Software
# Foundation, Inc., 59 Temple Place, Suite 330, Boston,
# MA 02111-1307 USA
#
A copy of the GPL is included below at item 2.
```

2. Linux kernel

NOTE! This copyright does *not* cover user programs that use kernel services by normal system calls - this is merely considered normal use of the kernel, and does *not* fall under the heading of "derived work".

Also note that the GPL below is copyrighted by the Free Software Foundation, but the instance of code that it refers to (the linux kernel) is copyrighted by me and others who actually wrote it.

Also note that the only valid version of the GPL as far as the kernel is concerned is `_this_` particular version of the license (ie v2, not v2.2 or v3.x or whatever), unless explicitly otherwise stated.

Linus Torvalds

GNU GENERAL PUBLIC LICENSE

Version 2, June 1991

Copyright (C) 1989, 1991 Free Software Foundation, Inc.
675 Mass Ave, Cambridge, MA 02139, USA

Everyone is permitted to copy and distribute verbatim copies of this license document, but changing it is not allowed.

Preamble

The licenses for most software are designed to take away your freedom to share and change it. By contrast, the GNU General Public License is intended to guarantee your freedom to share and change

free software--to make sure the software is free for all its users. This General Public License applies to most of the Free Software Foundation's software and to any other program whose authors commit to using it. (Some other Free Software Foundation software is covered by the GNU Library General Public License instead.) You can apply it to your programs, too.

When we speak of free software, we are referring to freedom, not price. Our General Public Licenses are designed to make sure that you have the freedom to distribute copies of free software (and charge for this service if you wish), that you receive source code or can get it if you want it, that you can change the software or use pieces of it in new free programs; and that you know you can do these things.

To protect your rights, we need to make restrictions that forbid anyone to deny you these rights or to ask you to surrender the rights. These restrictions translate to certain responsibilities for you if you distribute copies of the software, or if you modify it.

For example, if you distribute copies of such a program, whether gratis or for a fee, you must give the recipients all the rights that you have. You must make sure that they, too, receive or can get the source code. And you must show them these terms so they know their rights.

We protect your rights with two steps: (1) copyright the software, and (2) offer you this license which gives you legal permission to copy, distribute and/or modify the software.

Also, for each author's protection and ours, we want to make certain that everyone understands that there is no warranty for this free software. If the software is modified by someone else and passed on, we want its recipients to know that what they have is not the original, so that any problems introduced by others will not reflect on the original authors' reputations.

Finally, any free program is threatened constantly by software patents. We wish to avoid the danger that redistributors of a free program will individually obtain patent licenses, in effect making the program proprietary. To prevent this, we have made it clear that any patent must be licensed for everyone's free use or not licensed at all. The precise terms and conditions for copying, distribution and modification follow.

GNU GENERAL PUBLIC LICENSE

TERMS AND CONDITIONS FOR COPYING, DISTRIBUTION AND MODIFICATION

0. This License applies to any program or other work which contains a notice placed by the copyright holder saying it may be distributed under the terms of this General Public License. The "Program", below, refers to any such program or work, and a "work based on the Program" means either the Program or any derivative work under copyright law: that is to say, a work containing the Program or a portion of it, either verbatim or with modifications and/or translated into another language. (Hereinafter, translation is included without limitation in the term "modification".) Each licensee is addressed as "you".
Activities other than copying, distribution and modification are not covered by this License; they are outside its scope. The act of running the Program is not restricted, and the output from the Program is covered only if its contents constitute a work based on the Program (independent of having been made by running the Program). Whether that is true depends on what the Program does.
1. You may copy and distribute verbatim copies of the Program's source code as you receive it, in any medium, provided that you conspicuously and appropriately publish on each copy an appropriate copyright notice and disclaimer of warranty; keep intact all the notices that refer to this License and to the absence of any warranty; and give any other recipients of the Program a copy of this License along with the Program.

You may charge a fee for the physical act of transferring a copy, and you may at your option offer warranty protection in exchange for a fee.

2. You may modify your copy or copies of the Program or any portion of it, thus forming a work based on the Program, and copy and distribute such modifications or work under the terms of Section 1 above, provided that you also meet all of these conditions:
 - a) You must cause the modified files to carry prominent notices stating that you changed the files and the date of any change.
 - b) You must cause any work that you distribute or publish, that in whole or in part contains or is derived from the Program or any part thereof, to be licensed as a whole at no charge to all third parties under the terms of this License.
 - c) If the modified program normally reads commands interactively when run, you must cause it, when started running for such interactive use in the most ordinary way, to print or display an announcement including an appropriate copyright notice and a notice that there is no warranty (or else, saying that you provide a warranty) and that users may redistribute the program under these conditions, and telling the user how to view a copy of this License. (Exception: if the Program itself is interactive but does not normally print such an announcement, your work based on the Program is not required to print an announcement.)

These requirements apply to the modified work as a whole. If identifiable sections of that work are not derived from the Program, and can be reasonably considered independent and separate works in themselves, then this License, and its terms, do not apply to those sections when you distribute them as separate works. But when you distribute the same sections as part of a whole which is a work based on the Program, the distribution of the whole must be on the terms of this License, whose permissions for other licensees extend to the entire whole, and thus to each and every part regardless of who wrote it.

Thus, it is not the intent of this section to claim rights or contest your rights to work written entirely by you; rather, the intent is to exercise the right to control the distribution of derivative or collective works based on the Program.

In addition, mere aggregation of another work not based on the Program with the Program (or with a work based on the Program) on a volume of a storage or distribution medium does not bring the other work under the scope of this License.

3. You may copy and distribute the Program (or a work based on it, under Section 2) in object code or executable form under the terms of Sections 1 and 2 above provided that you also do one of the following:
 - a) Accompany it with the complete corresponding machine-readable source code, which must be distributed under the terms of Sections 1 and 2 above on a medium customarily used for software interchange; or
 - b) Accompany it with a written offer, valid for at least three years, to give any third party, for a charge no more than your cost of physically performing source distribution, a complete machine-readable copy of the corresponding source code, to be distributed under the terms of Sections 1 and 2 above on a medium customarily used for software interchange; or
 - c) Accompany it with the information you received as to the offer to distribute corresponding source code. (This alternative is allowed only for noncommercial distribution and only if you received the program in object code or executable form with such an offer; in accord with Subsection b above.)

The source code for a work means the preferred form of the work for making modifications to it. For an executable

work, complete source code means all the source code for all modules it contains, plus any associated interface definition files, plus the scripts used to control compilation and installation of the executable. However, as a special exception, the source code distributed need not include anything that is normally distributed (in either source or binary form) with the major components (compiler, kernel, and so on) of the operating system on which the executable runs, unless that component itself accompanies the executable.

If distribution of executable or object code is made by offering access to copy from a designated place, then offering equivalent access to copy the source code from the same place counts as distribution of the source code, even though third parties are not compelled to copy the source along with the object code.

4. You may not copy, modify, sublicense, or distribute the Program except as expressly provided under this License. Any attempt otherwise to copy, modify, sublicense or distribute the Program is void, and will automatically terminate your rights under this License. However, parties who have received copies, or rights, from you under this License will not have their licenses terminated so long as such parties remain in full compliance.
5. You are not required to accept this License, since you have not signed it. However, nothing else grants you permission to modify or distribute the Program or its derivative works. These actions are prohibited by law if you do not accept this License. Therefore, by modifying or distributing the Program (or any work based on the Program), you indicate your acceptance of this License to do so, and all its terms and conditions for copying, distributing or modifying the Program or works based on it.
6. Each time you redistribute the Program (or any work based on the Program), the recipient automatically receives a license from the original licensor to copy, distribute or modify the Program subject to these terms and conditions. You may not impose any further restrictions on the recipients' exercise of the rights granted herein. You are not responsible for enforcing compliance by third parties to this License.
7. If, as a consequence of a court judgment or allegation of patent infringement or for any other reason (not limited to patent issues), conditions are imposed on you (whether by court order, agreement or otherwise) that contradict the conditions of this License, they do not excuse you from the conditions of this License. If you cannot distribute so as to satisfy simultaneously your obligations under this License and any other pertinent obligations, then as a consequence you may not distribute the Program at all. For example, if a patent license would not permit royalty-free redistribution of the Program by all those who receive copies directly or indirectly through you, then the only way you could satisfy both it and this License would be to refrain entirely from distribution of the Program.

If any portion of this section is held invalid or unenforceable under any particular circumstance, the balance of the section is intended to apply and the section as a whole is intended to apply in other circumstances.

It is not the purpose of this section to induce you to infringe any patents or other property right claims or to contest validity of any such claims; this section has the sole purpose of protecting the integrity of the free software distribution system, which is implemented by public license practices. Many people have made generous contributions to the wide range of software distributed through that system in reliance on consistent application of that system; it is up to the author/donor to decide if he or she is willing to distribute software through any other system and a licensee cannot impose that choice.

This section is intended to make thoroughly clear what is believed to be a consequence of the rest of this License.

8. If the distribution and/or use of the Program is restricted in certain countries either by patents or by copyrighted interfaces, the original copyright holder who places the Program under this License may add an explicit geographical distribution limitation excluding those countries, so that distribution is permitted only in or among countries not thus excluded. In such case, this License incorporates the limitation as if written in the body of this License.
9. The Free Software Foundation may publish revised and/or new versions of the General Public License from time to time. Such new versions will be similar in spirit to the present version, but may differ in detail to address new problems or concerns. Each version is given a distinguishing version number. If the Program specifies a version number of this License which applies to it and "any later version", you have the option of following the terms and conditions either of that version or of any later version published by the Free Software Foundation. If the Program does not specify a version number of this License, you may choose any version ever published by the Free Software Foundation.
10. If you wish to incorporate parts of the Program into other free programs whose distribution conditions are different, write to the author to ask for permission. For software which is copyrighted by the Free Software Foundation, write to the Free Software Foundation; we sometimes make exceptions for this. Our decision will be guided by the two goals of preserving the free status of all derivatives of our free software and of promoting the sharing and reuse of software generally.

NO WARRANTY

11. BECAUSE THE PROGRAM IS LICENSED FREE OF CHARGE, THERE IS NO WARRANTY FOR THE PROGRAM, TO THE EXTENT PERMITTED BY APPLICABLE LAW, EXCEPT WHEN OTHERWISE STATED IN WRITING THE COPYRIGHT HOLDERS AND/OR OTHER PARTIES PROVIDE THE PROGRAM "AS IS" WITHOUT WARRANTY OF ANY KIND, EITHER EXPRESSED OR IMPLIED, INCLUDING, BUT NOT LIMITED TO, THE IMPLIED WARRANTIES OF MERCHANTABILITY AND FITNESS FOR A PARTICULAR PURPOSE. THE ENTIRE RISK AS TO THE QUALITY AND PERFORMANCE OF THE PROGRAM IS WITH YOU. SHOULD THE PROGRAM PROVE DEFECTIVE, YOU ASSUME THE COST OF ALL NECESSARY SERVICING, REPAIR OR CORRECTION.
12. IN NO EVENT UNLESS REQUIRED BY APPLICABLE LAW OR AGREED TO IN WRITING WILL ANY COPYRIGHT HOLDER, OR ANY OTHER PARTY WHO MAY MODIFY AND/OR REDISTRIBUTE THE PROGRAM AS PERMITTED ABOVE, BE LIABLE TO YOU FOR DAMAGES, INCLUDING ANY GENERAL, SPECIAL, INCIDENTAL OR CONSEQUENTIAL DAMAGES ARISING OUT OF THE USE OR INABILITY TO USE THE PROGRAM (INCLUDING BUT NOT LIMITED TO LOSS OF DATA OR DATA BEING RENDERED INACCURATE OR LOSSES SUSTAINED BY YOU OR THIRD PARTIES OR A FAILURE OF THE PROGRAM TO OPERATE WITH ANY OTHER PROGRAMS), EVEN IF SUCH HOLDER OR OTHER PARTY HAS BEEN ADVISED OF THE POSSIBILITY OF SUCH DAMAGES.

END OF TERMS AND CONDITIONS

Appendix: How to Apply These Terms to Your New Programs

If you develop a new program, and you want it to be of the greatest possible use to the public, the best way to achieve this is to make it free software which everyone can redistribute and change under these terms.

To do so, attach the following notices to the program. It is safest to attach them to the start of each source file to most effectively convey the exclusion of warranty; and each file should have at least the "copyright" line and a pointer to where the full notice is found.

<one line to give the program's name and a brief idea of what it does.>

Copyright (C) 19yy <name of author>

This program is free software; you can redistribute it and/or modify it under the terms of the GNU General Public License as published by the Free Software Foundation; either version 2 of the License, or (at your option) any later version.

This program is distributed in the hope that it will be useful, but WITHOUT ANY WARRANTY; without even the implied warranty of MERCHANTABILITY or FITNESS FOR A PARTICULAR PURPOSE. See the GNU General Public License for more details.

You should have received a copy of the GNU General Public License along with this program; if not, write to the Free Software Foundation, Inc., 675 Mass Ave, Cambridge, MA 02139, USA.

Also add information on how to contact you by electronic and paper mail.

If the program is interactive, make it output a short notice like this when it starts in an interactive mode:

Gnomovision version 69, Copyright (C) 19yy name of author

Gnomovision comes with ABSOLUTELY NO WARRANTY; for details type `show w`.

This is free software, and you are welcome to redistribute it under certain conditions; type `show c` for details.

The hypothetical commands `show w` and `show c` should show the appropriate parts of the General Public License. Of course, the commands you use may be called something other than `show w` and `show c`; they could even be mouse-clicks or menu items--whatever suits your program.

You should also get your employer (if you work as a programmer) or your school, if any, to sign a "copyright disclaimer" for the program, if necessary. Here is a sample; alter the names:

Yoyodyne, Inc., hereby disclaims all copyright interest in the program `Gnomovision' (which makes passes at compilers) written by James Hacker:

<signature of Ty Coon>, 1 April 1989

Ty Coon, President of Vice

This General Public License does not permit incorporating your program into proprietary programs. If your program is a subroutine library, you may consider it more useful to permit linking proprietary applications with the library. If this is what you want to do, use the GNU Library General Public License instead of this License.

3. Sysvinit 2.88dsf, module-init-tools 3.12, util-linux-ng 2.18, procps (ps, top) 3.2.8, psmisc 22.13, coreutils 6.9, gawk 3.1.5, grep 2.5.1a, findutils 4.2.31, bash 3.2.51, tar 1.17, sed 4.1.5, gzip 1.3.12, inetutils 1.4.2, UBIFS, mtd-utils, glibc, gcc, gconv 1.0.0, dhcpcv6 dibbler, gdb 6.6, iproute2 2.6.38, ntpdate 4.2.6, tcpdump 4.3.0, e2fsprogs 1.41.14, freetype, cpio, goahead, iputils, mongoose, nettools, udhcp, wifi-tools

All OSS modules mentioned in the section heading above are subject to the GPL, a copy of which is included in item 2.

4. Libnl, nopoll, nss-mdns, xz

GNU LESSER GENERAL PUBLIC LICENSE

Version 2.1, February 1999

Copyright (C) 1991, 1999 Free Software Foundation, Inc.
59 Temple Place, Suite 330, Boston, MA 02111-1307 USA

Everyone is permitted to copy and distribute verbatim copies of this license document, but changing it is not allowed.

[This is the first released version of the Lesser GPL. It also counts as the successor of the GNU Library Public License, version 2, hence the version number 2.1.]

Preamble

The licenses for most software are designed to take away your freedom to share and change it. By contrast, the GNU General Public Licenses are intended to guarantee your freedom to share and change free software--to make sure the software is free for all its users.

This license, the Lesser General Public License, applies to some specially designated software packages--typically libraries--of the Free Software Foundation and other authors who decide to use it. You can use it too, but we suggest you first think carefully about whether this license or the ordinary General Public License is the better strategy to use in any particular case, based on the explanations below.

When we speak of free software, we are referring to freedom of use, not price. Our General Public Licenses are designed to make sure that you have the freedom to distribute copies of free software (and charge for this service if you wish); that you receive source code or can get it if you want it; that you can change the software and use pieces of it in new free programs; and that you are informed that you can do these things.

To protect your rights, we need to make restrictions that forbid distributors to deny you these rights or to ask you to surrender these rights. These restrictions translate to certain responsibilities for you if you distribute copies of the library or if you modify it.

For example, if you distribute copies of the library, whether gratis or for a fee, you must give the recipients all the rights that we gave you. You must make sure that they, too, receive or can get the source code. If you link other code with the library, you must provide complete object files to the recipients, so that they can relink them with the library after making changes to the library and recompiling it. And you must show them these terms so they know their rights.

We protect your rights with a two-step method: (1) we copyright the library, and (2) we offer you this license, which gives you legal permission to copy, distribute and/or modify the library.

To protect each distributor, we want to make it very clear that there is no warranty for the free library. Also, if the library is modified by someone else and passed on, the recipients should know that what they have is not the original version, so that the original author's reputation will not be affected by problems that might be introduced by others.

Finally, software patents pose a constant threat to the existence of any free program. We wish to make sure that a company cannot effectively restrict the users of a free program by obtaining a restrictive license from a patent holder. Therefore, we insist that any patent license obtained for a version of the library must be consistent with the full freedom of use specified in this license.

Most GNU software, including some libraries, is covered by the ordinary GNU General Public License. This license, the GNU Lesser General Public License, applies to certain designated libraries, and is quite different from the ordinary General Public License. We use this license for certain libraries in order to permit linking those libraries into non-free programs.

When a program is linked with a library, whether statically or using a shared library, the combination of the two is legally speaking a combined work, a derivative of the original library. The ordinary

General Public License therefore permits such linking only if the entire combination fits its criteria of freedom. The Lesser General Public License permits more lax criteria for linking other code with the library.

We call this license the "Lesser" General Public License because it does Less to protect the user's freedom than the ordinary General Public License. It also provides other free software developers Less of an advantage over competing non-free programs. These disadvantages are the reason we use the ordinary General Public License for many libraries. However, the Lesser license provides advantages in certain special circumstances.

For example, on rare occasions, there may be a special need to encourage the widest possible use of a certain library, so that it becomes a de-facto standard. To achieve this, non-free programs must be allowed to use the library. A more frequent case is that a free library does the same job as widely used non-free libraries. In this case, there is little to gain by limiting the free library to free software only, so we use the Lesser General Public License.

In other cases, permission to use a particular library in non-free programs enables a greater number of people to use a large body of free software. For example, permission to use the GNU C Library in non-free programs enables many more people to use the whole GNU operating system, as well as its variant, the GNU/Linux operating system.

Although the Lesser General Public License is Less protective of the users' freedom, it

does ensure that the user of a program that is linked with the Library has the freedom and the wherewithal to run that program using a modified version of the Library.

The precise terms and conditions for copying, distribution and modification follow. Pay close attention to the difference between a "work based on the library" and a "work that uses the library". The former contains code derived from the library, whereas the latter must be combined with the library in order to run.

GNU LESSER GENERAL PUBLIC LICENSE

TERMS AND CONDITIONS FOR COPYING, DISTRIBUTION AND MODIFICATION

0. This License Agreement applies to any software library or other program which contains a notice placed by the copyright holder or other authorized party saying it may be distributed under the terms of this Lesser General Public License (also called "this License").

Each licensee is addressed as "you".

A "library" means a collection of software functions and/or data prepared so as to be conveniently linked with application programs (which use some of those functions and data) to form executables.

The "Library", below, refers to any such software library or work which has been distributed under these terms. A "work based on the Library" means either the Library or any derivative work under copyright law: that is to say, a work containing the Library or a portion of it, either verbatim or with modifications and/or translated straightforwardly into another language. (Hereinafter, translation is included without limitation in the term "modification".)

"Source code" for a work means the preferred form of the work for making modifications to it. For a library, complete source code means all the source code for all modules it contains, plus any associated interface definition files, plus the scripts used to control compilation and installation of the library.

Activities other than copying, distribution and modification are not covered by this License; they are outside its scope. The act of running a program using the Library is not restricted, and output from such a program is covered only if its contents

constitute a work based on the Library (independent of the use of the Library in a tool for writing it). Whether that is true depends on what the Library does and what the program that uses the Library does.

1. You may copy and distribute verbatim copies of the Library's complete source code as you receive it, in any medium, provided that you conspicuously and appropriately publish on each copy an appropriate copyright notice and disclaimer of warranty; keep intact all the notices that refer to this License and to the absence of any warranty; and distribute a copy of this License along with the Library.
You may charge a fee for the physical act of transferring a copy, and you may at your option offer warranty protection in exchange for a fee.
2. You may modify your copy or copies of the Library or any portion of it, thus forming a work based on the Library, and copy and distribute such modifications or work under the terms of Section 1 above, provided that you also meet all of these conditions:
 - a) The modified work must itself be a software library.
 - b) You must cause the files modified to carry prominent notices stating that you changed the files and the date of any change.
 - c) You must cause the whole of the work to be licensed at no charge to all third parties under the terms of this License.
 - d) If a facility in the modified Library refers to a function or a table of data to be supplied by an application program that uses the facility, other than as an argument passed when the facility is invoked, then you must make a good faith effort to ensure that, in the event an application does not supply such function or table, the facility still operates, and performs whatever part of its purpose remains meaningful.

(For example, a function in a library to compute square roots has a purpose that is entirely well-defined independent of the application. Therefore, Subsection 2d requires that any application-supplied function or table used by this function must be optional: if the application does not supply it, the square root function must still compute square roots.)

These requirements apply to the modified work as a whole. If identifiable sections of that work are not derived from the Library, and can be reasonably considered independent and separate works in themselves, then this License, and its terms, do not apply to those sections when you distribute them as separate works. But when you distribute the same sections as part of a whole which is a work based on the Library, the distribution of the whole must be on the terms of this License, whose permissions for other licensees extend to the entire whole, and thus to each and every part regardless of who wrote it.

Thus, it is not the intent of this section to claim rights or contest your rights to work written entirely by you; rather, the intent is to exercise the right to control the distribution of derivative or collective works based on the Library.

In addition, mere aggregation of another work not based on the Library with the Library (or with a work based on the Library) on a volume of a storage or distribution medium does not bring the other work under the scope of this License.

3. You may opt to apply the terms of the ordinary GNU General Public License instead of this License to a given copy of the Library. To do this, you must alter all the notices that refer to this License, so that they refer to the ordinary GNU General Public License, version 2, instead of to this License. (If a newer version than version 2 of the ordinary GNU General Public License has appeared, then you can specify that version instead if you wish.) Do not make any other change in these notices.

Once this change is made in a given copy, it is irreversible for that copy, so the ordinary GNU General Public License applies to all subsequent copies and derivative works made from that copy.

This option is useful when you wish to copy part of the code of the Library into a program that is not a library.

4. You may copy and distribute the Library (or a portion or derivative of it, under Section 2) in object code or executable form under the terms of Sections 1 and 2 above provided that you accompany it with the complete corresponding machine-readable source code, which must be distributed under the terms of Sections 1 and 2 above on a medium customarily used for software interchange.
If distribution of object code is made by offering access to copy from a designated place, then offering equivalent access to copy the source code from the same place satisfies the requirement to distribute the source code, even though third parties are not compelled to copy the source along with the object code.
5. A program that contains no derivative of any portion of the Library but is designed to work with the Library by being compiled or linked with it, is called a "work that uses the Library". Such a work, in isolation, is not a derivative work of the Library, and therefore falls outside the scope of this License. However, linking a "work that uses the Library" with the Library creates an executable that is a derivative of the Library (because it contains portions of the Library), rather than a "work that uses the library". The executable is therefore covered by this License. Section 6 states terms for distribution of such executables.

When a "work that uses the Library" uses material from a header file that is part of the Library, the object code for the work may be a derivative work of the Library even though the source code is not.

Whether this is true is especially significant if the work can be linked without the Library, or if the work is itself a library. The threshold for this to be true is not precisely defined by law.

If such an object file uses only numerical parameters, data structure layouts and accessors, and small macros and small inline functions (ten lines or less in length), then the use of the object file is unrestricted, regardless of whether it is legally a derivative work. (Executables containing this object code plus portions of the Library will still fall under Section 6.)

Otherwise, if the work is a derivative of the Library, you may distribute the object code for the work under the terms of Section 6.

Any executables containing that work also fall under Section 6, whether or not they are linked directly with the Library itself.

6. As an exception to the Sections above, you may also combine or link a "work that uses the Library" with the Library to produce a work containing portions of the Library, and distribute that work under terms of your choice, provided that the terms permit modification of the work for the customer's own use and reverse engineering for debugging such modifications.
You must give prominent notice with each copy of the work that the Library is used in it and that the Library and its use are covered by this License. You must supply a copy of this License. If the work during execution displays copyright notices, you must include the copyright notice for the Library among them, as well as a reference directing the user to the copy of this License. Also, you must do one of these things:
 - a) Accompany the work with the complete corresponding machine-readable source code for the Library including whatever changes were used in the work (which must be distributed under Sections 1 and 2 above); and, if the work

is an executable linked with the Library, with the complete machine-readable “work that uses the Library”, as object code and/or source code, so that the user can modify the Library and then relink to produce a modified executable containing the modified Library. (It is understood that the user who changes the contents of definitions files in the Library will not necessarily be able to recompile the application to use the modified definitions.)

- b) Use a suitable shared library mechanism for linking with the Library. A suitable mechanism is one that (1) uses at run time a copy of the library already present on the user's computer system, rather than copying library functions into the executable, and (2) will operate properly with a modified version of the library, if the user installs one, as long as the modified version is interface-compatible with the version that the work was made with.
- c) Accompany the work with a written offer, valid for at least three years, to give the same user the materials specified in Subsection 6a, above, for a charge no more than the cost of performing this distribution.
- d) If distribution of the work is made by offering access to copy from a designated place, offer equivalent access to copy the above specified materials from the same place.
- e) Verify that the user has already received a copy of these materials or that you have already sent this user a copy.

For an executable, the required form of the “work that uses the library” must include any data and utility programs needed for reproducing the executable from it. However, as a special exception, the materials to be distributed need not include anything that is normally distributed (in either source or binary form) with the major components (compiler, kernel, and so on) of the operating system on which the executable runs, unless that component itself accompanies the executable.

It may happen that this requirement contradicts the license restrictions of other proprietary libraries that do not normally accompany the operating system. Such a contradiction means you cannot use both them and the Library together in an executable that you distribute.

7. You may place library facilities that are a work based on the Library side-by-side in a single library together with other library facilities not covered by this License, and distribute such a combined library, provided that the separate distribution of the work based on the Library and of the other library facilities is otherwise permitted, and provided that you do these two things:
 - a) Accompany the combined library with a copy of the same work based on the Library, uncombined with any other library facilities. This must be distributed under the terms of the Sections above.
 - b) Give prominent notice with the combined library of the fact that part of it is a work based on the Library, and explaining where to find the accompanying uncombined form of the same work.
8. You may not copy, modify, sublicense, link with, or distribute the Library except as expressly provided under this License. Any attempt otherwise to copy, modify, sublicense, link with, or distribute the Library is void, and will automatically terminate your rights under this License. However, parties who have received copies, or rights, from you under this License will not have their licenses terminated so long as such parties remain in full compliance.
9. You are not required to accept this License, since you have not signed it. However, nothing else grants you permission to modify or distribute the Library or its derivative works. These actions are prohibited by law if you do not accept this License. Therefore, by modifying or distributing the Library (or any work

based on the Library), you indicate your acceptance of this License to do so, and all its terms and conditions for copying, distributing or modifying the Library or works based on it.

10. Each time you redistribute the Library (or any work based on the Library), the recipient automatically receives a license from the original licensor to copy, distribute, link with or modify the Library subject to these terms and conditions. You may not impose any further restrictions on the recipients' exercise of the rights granted herein.
You are not responsible for enforcing compliance by third parties with this License.
11. If, as a consequence of a court judgment or allegation of patent infringement or for any other reason (not limited to patent issues), conditions are imposed on you (whether by court order, agreement or otherwise) that contradict the conditions of this License, they do not excuse you from the conditions of this License. If you cannot distribute so as to satisfy simultaneously your obligations under this License and any other pertinent obligations, then as a consequence you may not distribute the Library at all. For example, if a patent license would not permit royalty-free redistribution of the Library by all those who receive copies directly or indirectly through you, then the only way you could satisfy both it and this License would be to refrain entirely from distribution of the Library.

If any portion of this section is held invalid or unenforceable under any particular circumstance, the balance of the section is intended to apply, and the section as a whole is intended to apply in other circumstances.

It is not the purpose of this section to induce you to infringe any patents or other property right claims or to contest validity of any such claims; this section has the sole purpose of protecting the integrity of the free software distribution system which is implemented by public license practices. Many people have made generous contributions to the wide range of software distributed through that system in reliance on consistent application of that system; it is up to the author/donor to decide if he or she is willing to distribute software through any other system and a licensee cannot impose that choice.

This section is intended to make thoroughly clear what is believed to be a consequence of the rest of this License.

12. If the distribution and/or use of the Library is restricted in certain countries either by patents or by copyrighted interfaces, the original copyright holder who places the Library under this License may add an explicit geographical distribution limitation excluding those countries, so that distribution is permitted only in or among countries not thus excluded. In such case, this License incorporates the limitation as if written in the body of this License.
13. The Free Software Foundation may publish revised and/or new versions of the Lesser General Public License from time to time. Such new versions will be similar in spirit to the present version, but may differ in detail to address new problems or concerns.
Each version is given a distinguishing version number. If the Library specifies a version number of this License which applies to it and “any later version”, you have the option of following the terms and conditions either of that version or of any later version published by the Free Software Foundation. If the Library does not specify a license version number, you may choose any version ever published by the Free Software Foundation.
14. If you wish to incorporate parts of the Library into other free programs whose distribution conditions are incompatible with these, write to the author to ask for permission. For software which is copyrighted by the Free Software Foundation, write to the Free Software Foundation; we sometimes make exceptions

for this. Our decision will be guided by the two goals of preserving the free status of all derivatives of our free software and of promoting the sharing and reuse of software generally.

NO WARRANTY

15. BECAUSE THE LIBRARY IS LICENSED FREE OF CHARGE, THERE IS NO WARRANTY FOR THE LIBRARY, TO THE EXTENT PERMITTED BY APPLICABLE LAW, EXCEPT WHEN OTHERWISE STATED IN WRITING THE COPYRIGHT HOLDERS AND/OR OTHER PARTIES PROVIDE THE LIBRARY "AS IS" WITHOUT WARRANTY OF ANY KIND, EITHER EXPRESSED OR IMPLIED, INCLUDING, BUT NOT LIMITED TO, THE IMPLIED WARRANTIES OF MERCHANTABILITY AND FITNESS FOR A PARTICULAR PURPOSE. THE ENTIRE RISK AS TO THE QUALITY AND PERFORMANCE OF THE LIBRARY IS WITH YOU. SHOULD THE LIBRARY PROVE DEFECTIVE, YOU ASSUME THE COST OF ALL NECESSARY SERVICING, REPAIR OR CORRECTION.
16. IN NO EVENT UNLESS REQUIRED BY APPLICABLE LAW OR AGREED TO IN WRITING WILL ANY COPYRIGHT HOLDER, OR ANY OTHER PARTY WHO MAY MODIFY AND/OR REDISTRIBUTE THE LIBRARY AS PERMITTED ABOVE, BE LIABLE TO YOU FOR DAMAGES, INCLUDING ANY GENERAL, SPECIAL, INCIDENTAL OR CONSEQUENTIAL DAMAGES ARISING OUT OF THE USE OR INABILITY TO USE THE LIBRARY (INCLUDING BUT NOT LIMITED TO LOSS OF DATA OR DATA BEING RENDERED INACCURATE OR LOSSES SUSTAINED BY YOU OR THIRD PARTIES OR A FAILURE OF THE LIBRARY TO OPERATE WITH ANY OTHER SOFTWARE), EVEN IF SUCH HOLDER OR OTHER PARTY HAS BEEN ADVISED OF THE POSSIBILITY OF SUCH DAMAGES.

END OF TERMS AND CONDITIONS

How to Apply These Terms to Your New Libraries

If you develop a new library, and you want it to be of the greatest possible use to the public, we recommend making it free software that everyone can redistribute and change. You can do so by permitting redistribution under these terms (or, alternatively, under the terms of the ordinary General Public License).

To apply these terms, attach the following notices to the library. It is safest to attach them to the start of each source file to most effectively convey the exclusion of warranty; and each file should have at least the "copyright" line and a pointer to where the full notice is found.

<one line to give the library's name and a brief idea of what it does.>

Copyright (C) <year> <name of author>

This library is free software; you can redistribute it and/or modify it under the terms of the GNU Lesser General Public License as published by the Free Software Foundation; either version 2.1 of the License, or (at your option) any later version.

This library is distributed in the hope that it will be useful, but WITHOUT ANY WARRANTY; without even the implied warranty of MERCHANTABILITY or FITNESS FOR A PARTICULAR PURPOSE. See the GNU Lesser General Public License for more details.

You should have received a copy of the GNU Lesser General Public License along with this library; if not, write to the Free Software Foundation, Inc., 59 Temple Place, Suite 330, Boston, MA 02111-1307 USA

Also add information on how to contact you by electronic and paper mail.

You should also get your employer (if you work as a programmer) or your school, if any, to sign a "copyright disclaimer" for the library, if necessary. Here is a sample; alter the names:

Yoyodyne, Inc., hereby disclaims all copyright interest in the library 'Frob' (a library for tweaking knobs) written by James Random Hacker.
<signature of Ty Coon>, 1 April 1990

Ty Coon, President of Vice

That's all there is to it!

5. OpenSSL.

Open SSL is an Open Source toolkit implementing the Secure Sockets Layer (SSL v2/v3) and Transport Layer Security (TLS v1) protocols as well as a full-strength general purpose cryptography library.

See <http://www.openssl.org/>, and in particular <http://www.openssl.org/source/license.html>.

The license conditions are copied below.

The OpenSSL toolkit stays under a dual license, i.e. both the conditions of the OpenSSL License and the original SSLeay license apply to the toolkit.

See below for the actual license texts. Actually both licenses are BSD-style

Open Source licenses. In case of any license issues related to OpenSSL, please contact openssl-core@openssl.org.

OpenSSL License

```
-----
/* =====
 * Copyright (c) 1998-2008 The OpenSSL Project. All rights reserved.
 *
 * Redistribution and use in source and binary forms, with or without
 * modification, are permitted provided that the following conditions
 * are met:
 *
 * 1. Redistributions of source code must retain the above copyright
 * notice, this list of conditions and the following disclaimer:
 *
 * 2. Redistributions in binary form must reproduce the above
 * copyright notice, this list of conditions and the following
 * disclaimer in the documentation and/or other materials
 * provided with the distribution.
 *
 * 3. All advertising materials mentioning features or use of this
 * software must display the following acknowledgment: "This
 * product includes software developed by the OpenSSL Project
 * for use in the OpenSSL Toolkit. (http://www.openssl.org/)"
 *
 * 4. The names "OpenSSL Toolkit" and "OpenSSL Project" must not
 * be used to endorse or promote products derived from this
 * software without prior written permission. For written
 * permission, please contact openssl-core@openssl.org.
 *
 * 5. Products derived from this software may not be called
 * "OpenSSL" nor may "OpenSSL" appear in their names without
 * prior written permission of the OpenSSL Project.
 *
 * 6. Redistributions of any form whatsoever must retain the
 * following acknowledgment: "This product includes software
 * developed by the OpenSSL Project for use in the OpenSSL
 * Toolkit (http://www.openssl.org/)"
 *
 * THIS SOFTWARE IS PROVIDED BY THE OpenSSL PROJECT
 * "AS IS" AND ANY EXPRESSED OR IMPLIED WARRANTIES,
 * INCLUDING, BUT NOT LIMITED TO, THE IMPLIED WARRANTIES
 * OF MERCHANTABILITY AND FITNESS FOR A PARTICULAR
 * PURPOSE ARE DISCLAIMED. IN NO EVENT SHALL THE
 * OpenSSL PROJECT OR ITS CONTRIBUTORS BE LIABLE FOR
```

```
* ANY DIRECT, INDIRECT, INCIDENTAL, SPECIAL, EXEMPLARY,
* OR CONSEQUENTIAL DAMAGES (INCLUDING, BUT NOT
* LIMITED TO, PROCUREMENT OF SUBSTITUTE GOODS OR
* SERVICES; LOSS OF USE, DATA, OR PROFITS; OR BUSINESS
* INTERRUPTION) HOWEVER CAUSED AND ON ANY THEORY
* OF LIABILITY, WHETHER IN CONTRACT, STRICT LIABILITY, OR
* TORT (INCLUDING NEGLIGENCE OR OTHERWISE) ARISING
* IN ANY WAY OUT OF THE USE OF THIS SOFTWARE, EVEN IF
* ADVISED OF THE POSSIBILITY OF SUCH DAMAGE.
* =====
*
```

```
* This product includes cryptographic software written by Eric
* Young(eay@cryptsoft.com).
* This product includes software written by Tim Hudson
* (tjh@cryptsoft.com).
*
*/
```

Original SSLLeay License

```
-----
/* Copyright (C) 1995-1998 Eric Young (eay@cryptsoft.com)
* All rights reserved.
*
* This package is an SSL implementation written by Eric Young
* (eay@cryptsoft.com).
* The implementation was written so as to conform with Netscapes
* SSL.
*
* This library is free for commercial and non-commercial use as long
* as the following conditions are aheared to. The following conditions
* apply to all code found in this distribution, be it the RC4, RSA,
* lhash, DES, etc., code; not just the SSL code. The SSL documentation
* included with this distribution is covered by the same copyright
* terms except that the holder is Tim Hudson (tjh@cryptsoft.com).
*
* Copyright remains Eric Young's, and as such any Copyright notices in
* the code are not to be removed. If this package is used in a
* product, Eric Young should be given attribution as the author of the
* parts of the library used. This can be in the form of a textual
* message at program startup or in documentation (online or
* textual) provided with the package.
*
* Redistribution and use in source and binary forms, with or without
* modification, are permitted provided that the following conditions
* are met:
*
* 1. Redistributions of source code must retain the copyright notice,
* this list of conditions and the following disclaimer.
*
* 2. Redistributions in binary form must reproduce the above
* copyright notice, this list of conditions and the following
* disclaimer in the documentation and/or other materials
* provided with the distribution.
*
* 3. All advertising materials mentioning features or use of this
* software must display the following acknowledgement: "This
* product includes cryptographic software written by Eric Young
* (eay@cryptsoft.com)" The word 'cryptographic' can be left out if
* the rouines from the library being used are not cryptographic
* related :-).
*
* 4. If you include any Windows specific code (or a derivative
* thereof) from the apps directory (application code) you must
* include an acknowledgement: "This product includes software
* written by Tim Hudson (tjh@cryptsoft.com)"
*
* THIS SOFTWARE IS PROVIDED BY ERIC YOUNG "AS IS" AND
* ANY EXPRESS OR IMPLIED WARRANTIES, INCLUDING,
* BUT NOT LIMITED TO, THE IMPLIED WARRANTIES OF
* MERCHANTABILITY AND FITNESS FOR A PARTICULAR
```

```
* PURPOSE ARE DISCLAIMED. IN NO EVENT SHALL
* THE AUTHOR OR CONTRIBUTORS BE LIABLE FOR ANY
* DIRECT, INDIRECT, INCIDENTAL, SPECIAL, EXEMPLARY,
* OR CONSEQUENTIAL DAMAGES (INCLUDING, BUT NOT
* LIMITED TO, PROCUREMENT OF SUBSTITUTE GOODS OR
* SERVICES; LOSS OF USE, DATA, OR PROFITS; OR BUSINESS
* INTERRUPTION) HOWEVER CAUSED AND ON ANY THEORY
* OF LIABILITY, WHETHER IN CONTRACT, STRICT LIABILITY, OR
* TORT (INCLUDING NEGLIGENCE OR OTHERWISE) ARISING
* IN ANY WAY OUT OF THE USE OF THIS SOFTWARE, EVEN IF
* ADVISED OF THE POSSIBILITY OF SUCH DAMAGE.
*
* The licence and distribution terms for any publicly available version
* or derivative of this code cannot be changed. i.e. this code cannot
* simply be copied and put under another distribution licence
* [including the GNU Public Licence.]
*/
```

6. Zlib general purpose compression library

See <http://www.zlib.net/>, and in particular http://www.zlib.net/zlib_license.html.

```
/* zlib.h -- interface of the 'zlib' general purpose compression library
version 1.2.3, July 18th, 2005
Copyright (C) 1995-2005 Jean-loup Gailly and Mark Adler
This software is provided 'as-is', without any express or implied
warranty. In no event will the authors be held liable for any damages
arising from the use of this software.
Permission is granted to anyone to use this software for any purpose,
including commercial applications, and to alter it and redistribute it
freely, subject to the following restrictions:
1. The origin of this software must not be misrepresented; you must
not claim that you wrote the original software. If you use
this software in a product, an acknowledgment in the product
documentation would be appreciated but is not required.
2. Altered source versions must be plainly marked as such, and
must not be misrepresented as being the original software.
3. This notice may not be removed or altered from any source
distribution.
```

Jean-loup Gailly jloup@gzip.org
Mark Adler madler@alumni.caltech.edu
*/

7. Freetype, a Free, High-Quality, and Portable Font Engine

The software is based in part of the work of the FreeType Team.
See <http://freetype.sourceforge.net/>, and in particular <http://freetype.sourceforge.net/FTL.TXT>.

Portions of the relevant license conditions are copied below.
The FreeType Project LICENSE 2006-Jan-27
Copyright 1996-2002, 2006 by David Turner, Robert Wilhelm, and
Werner Lemberg
...
1. No Warranty

```
-----
THE FREETYPE PROJECT IS PROVIDED 'AS IS' WITHOUT
WARRANTY OF ANY KIND, EITHER EXPRESS OR IMPLIED,
INCLUDING, BUT NOT LIMITED TO, WARRANTIES OF
MERCHANTABILITY AND FITNESS FOR A PARTICULAR
PURPOSE. IN NO EVENT WILL ANY OF THE AUTHORS OR
COPYRIGHT HOLDERS BE LIABLE FOR ANY DAMAGES
```

CAUSED BY THE USE OR THE INABILITY TO USE, OF THE
FREETYPE PROJECT.

2. Redistribution

This license grants a worldwide, royalty-free, perpetual and irrevocable right and license to use, execute, perform, compile, display, copy, create derivative works of, distribute and sublicense the FreeType Project (in both source and object code forms) and derivative works thereof for any purpose; and to authorize others to exercise some or all of the rights granted herein, subject to the following conditions:

- ...
- o Redistribution in binary form must provide a disclaimer that states that the software is based in part of the work of the FreeType Team, in the distribution documentation. We also encourage you to put an URL to the FreeType web page in your documentation, though this isn't mandatory.
- ...

8. Expat

Copyright (c) 1998, 1999, 2000 Thai Open Source Software Center Ltd and Clark Cooper

Copyright (c) 2001, 2002, 2003, 2004, 2005, 2006 Expat maintainers.

Permission is hereby granted, free of charge, to any person obtaining a copy of this software and associated documentation files (the "Software"), to deal in the Software without restriction, including without limitation the rights to use, copy, modify, merge, publish, distribute, sublicense, and/or sell copies of the Software, and to permit persons to whom the Software is furnished to do so, subject to the following conditions:

The above copyright notice and this permission notice shall be included in all copies or substantial portions of the Software.

THE SOFTWARE IS PROVIDED "AS IS", WITHOUT WARRANTY OF ANY KIND, EXPRESS OR IMPLIED, INCLUDING BUT NOT LIMITED TO THE WARRANTIES OF MERCHANTABILITY, FITNESS FOR A PARTICULAR PURPOSE AND NONINFRINGEMENT.

IN NO EVENT SHALL THE AUTHORS OR COPYRIGHT HOLDERS BE LIABLE FOR ANY CLAIM, DAMAGES OR OTHER LIABILITY, WHETHER IN AN ACTION OF CONTRACT, TORT OR OTHERWISE, ARISING FROM, OUT OF OR IN CONNECTION WITH THE SOFTWARE OR THE USE OR OTHER DEALINGS IN THE SOFTWARE.

9. libpng

This copy of the libpng notices is provided for your convenience. In case of any discrepancy between this copy and the notices in the file png.h that is included in the libpng distribution, the latter shall prevail. COPYRIGHT NOTICE, DISCLAIMER, and LICENSE:

If you modify libpng you may insert additional notices immediately following this sentence.

This code is released under the libpng license.

libpng versions 1.2.6, August 15, 2004, through 1.2.35, February 14, 2009, are Copyright (c) 2004, 2006-2009 Glenn Randers-Pehrson, and are distributed according to the same disclaimer and license as libpng-1.2.5 with the following individual added to the list of Contributing Authors

Cosmin Truta

libpng versions 1.0.7, July 1, 2000, through 1.2.5 - October 3, 2002, are Copyright (c) 2000-2002 Glenn Randers-Pehrson, and are distributed according to the same disclaimer and license as libpng-1.0.6 with the following individuals added to the list of Contributing Authors
Simon-Pierre Cadieux

Eric S. Raymond
Gilles Vollant

and with the following additions to the disclaimer:

There is no warranty against interference with your enjoyment of the library or against infringement. There is no warranty that our efforts or the library will fulfill any of your particular purposes or needs. This library is provided with all faults, and the entire risk of satisfactory quality, performance, accuracy, and effort is with the user:

libpng versions 0.97, January 1998, through 1.0.6, March 20, 2000, are Copyright (c) 1998, 1999 Glenn Randers-Pehrson, and are distributed according to the same disclaimer and license as libpng-0.96, with the following individuals added to the list of Contributing Authors:

Tom Lane

Glenn Randers-Pehrson

Willem van Schaik

libpng versions 0.89, June 1996, through 0.96, May 1997, are Copyright (c) 1996, 1997 Andreas Dilger

Distributed according to the same disclaimer and license as libpng-0.88, with the following individuals added to the list of Contributing Authors:

John Bowler

Kevin Bracey

Sam Bushell

Magnus Holmgren

Greg Roelofs

Tom Tanner

libpng versions 0.5, May 1995, through 0.88, January 1996, are

Copyright (c) 1995, 1996 Guy Eric Schalnat, Group 42, Inc.

For the purposes of this copyright and license, "Contributing Authors" is defined as the following set of individuals:

Andreas Dilger

Dave Martindale

Guy Eric Schalnat

Paul Schmidt

Tim Wegner

The PNG Reference Library is supplied "AS IS". The Contributing Authors and Group 42, Inc. disclaim all warranties, expressed or implied, including, without limitation, the warranties of merchantability and of fitness for any purpose. The Contributing Authors and Group 42, Inc. assume no liability for direct, indirect, incidental, special, exemplary, or consequential damages, which may result from the use of the PNG Reference Library, even if advised of the possibility of such damage.

Permission is hereby granted to use, copy, modify, and distribute this source code, or portions hereof, for any purpose, without fee, subject to the following restrictions:

1. The origin of this source code must not be misrepresented.
2. Altered versions must be plainly marked as such and must not be misrepresented as being the original source.
3. This Copyright notice may not be removed or altered from any source or altered source distribution.

The Contributing Authors and Group 42, Inc. specifically permit, without fee, and encourage the use of this source code as a component to supporting the PNG file format in commercial products. If you use this source code in a product, acknowledgment is not required but would be appreciated.

A "png_get_copyright" function is available, for convenient use in "about" boxes and the like:

```
printf("%s", png_get_copyright(NULL));
```

Also, the PNG logo (in PNG format, of course) is supplied in the files "pngbar.png" and "pngbar.jpg (88x31)" and "pngnow.png" (98x31).

libpng is OSI Certified Open Source Software. OSI Certified Open Source is a certification mark of the Open Source Initiative.

10. SQLite

All of the deliverable code in SQLite has been dedicated to the HYPERLINK "http://en.wikipedia.org/wiki/Public_Domain" public domain by the authors. All code authors, and representatives of the companies they work for, have signed affidavits dedicating their contributions to the public domain and originals of those signed affidavits are stored in a fire safe at the main offices of HYPERLINK "<http://www.hwaci.com>" Hwaci. Anyone is free to copy, modify, publish, use, compile, sell, or distribute the original SQLite code, either in source code form or as a compiled binary, for any purpose, commercial or non-commercial, and by any means.

The previous paragraph applies to the deliverable code in SQLite - those parts of the SQLite library that you actually bundle and ship with a larger application. Portions of the documentation and some code used as part of the build process might fall under other licenses. The details here are unclear: We do not worry about the licensing of the documentation and build code so much because none of these things are part of the core deliverable SQLite library.

All of the deliverable code in SQLite has been written from scratch. No code has been taken from other projects or from the open internet. Every line of code can be traced back to its original author, and all of those authors have public domain dedications on file. So the SQLite code base is clean and is uncontaminated with licensed code from other projects.

11. ncurses 5.7

- Copyright (c) 1998-2000,2006 Free Software Foundation, Inc.
- Permission is hereby granted, free of charge, to any person obtaining a copy of this software and associated documentation files (the "Software"), to deal in the Software without restriction, including without limitation the rights to use, copy, modify, merge, publish, distribute, distribute with modifications, sublicense, and/or sell copies of the Software, and to permit persons to whom the Software is furnished to do so, subject to the following conditions:
- The above copyright notice and this permission notice shall be included in all copies or substantial portions of the Software.
- THE SOFTWARE IS PROVIDED "AS IS", WITHOUT WARRANTY OF ANY KIND, EXPRESS OR IMPLIED, INCLUDING BUT NOT LIMITED TO THE WARRANTIES OF MERCHANTABILITY, FITNESS FOR A PARTICULAR PURPOSE AND NONINFRINGEMENT. IN NO EVENT SHALL THE ABOVE COPYRIGHT HOLDERS BE LIABLE FOR ANY CLAIM, DAMAGES OR OTHER LIABILITY, WHETHER IN AN ACTION OF CONTRACT, TORT OR OTHERWISE, ARISING FROM, OUT OF OR IN CONNECTION WITH THE SOFTWARE OR THE USE OR OTHER DEALINGS IN THE SOFTWARE.
- Except as contained in this notice, the name(s) of the above copyright holders shall not be used in advertising or otherwise to promote the sale, use or other dealings in this Software without prior written authorization.

12. glibc (other licenses) v2.19

This file contains the copying permission notices for various files in the GNU C Library distribution that have copyright owners other than the Free Software Foundation. These notices all require that a copy of the notice be included in the accompanying documentation and be distributed with binary distributions of the code, so be sure to include this file along with any binary distributions derived from the

GNU C Library.
All code incorporated from 4.4 BSD is distributed under the following license:

Copyright (C) 1991 Regents of the University of California.
All rights reserved.

Redistribution and use in source and binary forms, with or without modification, are permitted provided that the following conditions are met:

1. Redistributions of source code must retain the above copyright notice, this list of conditions and the following disclaimer.
2. Redistributions in binary form must reproduce the above copyright notice, this list of conditions and the following disclaimer in the documentation and/or other materials provided with the distribution.
3. [This condition was removed.]
4. Neither the name of the University nor the names of its contributors may be used to endorse or promote products derived from this software without specific prior written permission.

THIS SOFTWARE IS PROVIDED BY THE REGENTS AND CONTRIBUTORS "AS IS" AND ANY EXPRESS OR IMPLIED WARRANTIES, INCLUDING, BUT NOT LIMITED TO, THE IMPLIED WARRANTIES OF MERCHANTABILITY AND FITNESS FOR A PARTICULAR PURPOSE ARE DISCLAIMED. IN NO EVENT SHALL THE REGENTS OR CONTRIBUTORS BE LIABLE FOR ANY DIRECT, INDIRECT, INCIDENTAL, SPECIAL, EXEMPLARY, OR CONSEQUENTIAL DAMAGES (INCLUDING, BUT NOT LIMITED TO, PROCUREMENT OF SUBSTITUTE GOODS OR SERVICES; LOSS OF USE, DATA, OR PROFITS; OR BUSINESS INTERRUPTION) HOWEVER CAUSED AND ON ANY THEORY OF LIABILITY, WHETHER IN CONTRACT, STRICT LIABILITY, OR TORT (INCLUDING NEGLIGENCE OR OTHERWISE) ARISING IN ANY WAY OUT OF THE USE OF THIS SOFTWARE, EVEN IF ADVISED OF THE POSSIBILITY OF SUCH DAMAGE.

The DNS resolver code, taken from BIND 4.9.5, is copyrighted by UC Berkeley, by Digital Equipment Corporation and by Internet Software Consortium. The DEC portions are under the following license:

Portions Copyright (C) 1993 by Digital Equipment Corporation.
Permission to use, copy, modify, and distribute this software for any purpose with or without fee is hereby granted, provided that the above copyright notice and this permission notice appear in all copies, and that the name of Digital Equipment Corporation not be used in advertising or publicity pertaining to distribution of the document or software without specific, written prior permission.

THE SOFTWARE IS PROVIDED "AS IS" AND DIGITAL EQUIPMENT CORP. DISCLAIMS ALL WARRANTIES WITH REGARD TO THIS SOFTWARE, INCLUDING ALL IMPLIED WARRANTIES OF MERCHANTABILITY AND FITNESS. IN NO EVENT SHALL DIGITAL EQUIPMENT CORPORATION BE LIABLE FOR ANY SPECIAL, DIRECT, INDIRECT, OR CONSEQUENTIAL DAMAGES OR ANY DAMAGES WHATSOEVER RESULTING FROM LOSS OF USE, DATA OR PROFITS, WHETHER IN AN ACTION OF CONTRACT, NEGLIGENCE OR OTHER TORTIOUS ACTION, ARISING OUT OF OR IN CONNECTION WITH THE USE OR PERFORMANCE OF THIS SOFTWARE.

The ISC portions are under the following license:
Portions Copyright (c) 1996-1999 by Internet Software Consortium.

Permission to use, copy, modify, and distribute this software for any purpose with or without fee is hereby granted, provided that the above copyright notice and this permission notice appear in all copies.

THE SOFTWARE IS PROVIDED "AS IS" AND INTERNET SOFTWARE CONSORTIUM DISCLAIMS ALL WARRANTIES WITH REGARD TO THIS SOFTWARE INCLUDING ALL IMPLIED WARRANTIES OF MERCHANTABILITY AND FITNESS. IN NO

EVENT SHALL INTERNET SOFTWARE CONSORTIUM BE LIABLE FOR ANY SPECIAL, DIRECT, INDIRECT, OR CONSEQUENTIAL DAMAGES OR ANY DAMAGES WHATSOEVER RESULTING FROM LOSS OF USE, DATA OR PROFITS, WHETHER IN AN ACTION OF CONTRACT, NEGLIGENCE OR OTHER TORTIOUS ACTION, ARISING OUT OF OR IN CONNECTION WITH THE USE OR PERFORMANCE OF THIS SOFTWARE.

The Sun RPC support (from rpcsrc-4.0) is covered by the following license:

Copyright (c) 2010, Oracle America, Inc.

Redistribution and use in source and binary forms, with or without modification, are permitted provided that the following conditions are met:

- * Redistributions of source code must retain the above copyright notice, this list of conditions and the following disclaimer:
- * Redistributions in binary form must reproduce the above copyright notice, this list of conditions and the following disclaimer in the documentation and/or other materials provided with the distribution.
- * Neither the name of the "Oracle America, Inc." nor the names of its contributors may be used to endorse or promote products derived from this software without specific prior written permission.

THIS SOFTWARE IS PROVIDED BY THE COPYRIGHT HOLDERS AND CONTRIBUTORS "AS IS" AND ANY EXPRESS OR IMPLIED WARRANTIES, INCLUDING, BUT NOT LIMITED TO, THE IMPLIED WARRANTIES OF MERCHANTABILITY AND FITNESS FOR A PARTICULAR PURPOSE ARE DISCLAIMED. IN NO EVENT SHALL THE COPYRIGHT HOLDER OR CONTRIBUTORS BE LIABLE FOR ANY DIRECT, INDIRECT, INCIDENTAL, SPECIAL, EXEMPLARY, OR CONSEQUENTIAL DAMAGES (INCLUDING, BUT NOT LIMITED TO, PROCUREMENT OF SUBSTITUTE GOODS OR SERVICES; LOSS OF USE, DATA, OR PROFITS; OR BUSINESS INTERRUPTION) HOWEVER CAUSED AND ON ANY THEORY OF LIABILITY, WHETHER IN CONTRACT, STRICT LIABILITY, OR TORT (INCLUDING NEGLIGENCE OR OTHERWISE) ARISING IN ANY WAY OUT OF THE USE OF THIS SOFTWARE, EVEN IF ADVISED OF THE POSSIBILITY OF SUCH DAMAGE.

The following CMU license covers some of the support code for Mach, derived from Mach 3.0:

Mach Operating System

Copyright (C) 1991,1990,1989 Carnegie Mellon University
All Rights Reserved.

Permission to use, copy, modify and distribute this software and its documentation is hereby granted, provided that both the copyright notice and this permission notice appear in all copies of the software, derivative works or modified versions, and any portions thereof, and that both notices appear in supporting documentation.

CARNEGIE MELLON ALLOWS FREE USE OF THIS SOFTWARE IN ITS "AS IS" CONDITION. CARNEGIE MELLON DISCLAIMS ANY LIABILITY OF ANY KIND FOR ANY DAMAGES WHATSOEVER RESULTING FROM THE USE OF THIS SOFTWARE.

Carnegie Mellon requests users of this software to return to

Software Distribution Coordinator

School of Computer Science

Carnegie Mellon University

Pittsburgh PA 15213-3890

or Software.Distribution@CS.CMU.EDU any improvements or extensions that they make and grant Carnegie Mellon the rights to redistribute these changes.

The file if_ppp.h is under the following CMU license:

Redistribution and use in source and binary forms, with or without modification, are permitted provided that the following conditions are met:

1. Redistributions of source code must retain the above copyright notice, this list of conditions and the following disclaimer:
 2. Redistributions in binary form must reproduce the above copyright notice, this list of conditions and the following disclaimer in the documentation and/or other materials provided with the distribution.
 3. Neither the name of the University nor the names of its contributors may be used to endorse or promote products derived from this software without specific prior written permission.
- THIS SOFTWARE IS PROVIDED BY CARNEGIE MELLON UNIVERSITY AND CONTRIBUTORS "AS IS" AND ANY EXPRESS OR IMPLIED WARRANTIES, INCLUDING, BUT NOT LIMITED TO, THE IMPLIED WARRANTIES OF MERCHANTABILITY AND FITNESS FOR A PARTICULAR PURPOSE ARE DISCLAIMED. IN NO EVENT SHALL THE UNIVERSITY OR CONTRIBUTORS BE LIABLE FOR ANY DIRECT, INDIRECT, INCIDENTAL, SPECIAL, EXEMPLARY, OR CONSEQUENTIAL DAMAGES (INCLUDING, BUT NOT LIMITED TO, PROCUREMENT OF SUBSTITUTE GOODS OR SERVICES; LOSS OF USE, DATA, OR PROFITS; OR BUSINESS INTERRUPTION) HOWEVER CAUSED AND ON ANY THEORY OF LIABILITY, WHETHER IN CONTRACT, STRICT LIABILITY, OR TORT (INCLUDING NEGLIGENCE OR OTHERWISE) ARISING IN ANY WAY OUT OF THE USE OF THIS SOFTWARE, EVEN IF ADVISED OF THE POSSIBILITY OF SUCH DAMAGE.

The following license covers the files from Intel's "Highly Optimized Mathematical Functions for Itanium" collection:

Intel License Agreement

Copyright (c) 2000, Intel Corporation

All rights reserved.

Redistribution and use in source and binary forms, with or without modification, are permitted provided that the following conditions are met:

- * Redistributions of source code must retain the above copyright notice, this list of conditions and the following disclaimer:
- * Redistributions in binary form must reproduce the above copyright notice, this list of conditions and the following disclaimer in the documentation and/or other materials provided with the distribution.
- * The name of Intel Corporation may not be used to endorse or promote products derived from this software without specific prior written permission.

THIS SOFTWARE IS PROVIDED BY THE COPYRIGHT HOLDERS AND CONTRIBUTORS "AS IS" AND ANY EXPRESS OR IMPLIED WARRANTIES, INCLUDING, BUT NOT LIMITED TO, THE IMPLIED WARRANTIES OF MERCHANTABILITY AND FITNESS FOR A PARTICULAR PURPOSE ARE DISCLAIMED. IN NO EVENT SHALL INTEL OR CONTRIBUTORS BE LIABLE FOR ANY DIRECT, INDIRECT, INCIDENTAL, SPECIAL, EXEMPLARY, OR CONSEQUENTIAL DAMAGES (INCLUDING, BUT NOT LIMITED TO, PROCUREMENT OF SUBSTITUTE GOODS OR SERVICES; LOSS OF USE, DATA, OR PROFITS; OR BUSINESS INTERRUPTION) HOWEVER CAUSED AND ON ANY THEORY OF LIABILITY, WHETHER IN CONTRACT, STRICT LIABILITY, OR TORT (INCLUDING NEGLIGENCE OR OTHERWISE) ARISING IN ANY WAY OUT OF THE USE OF THIS SOFTWARE, EVEN IF ADVISED OF THE POSSIBILITY OF SUCH DAMAGE.

The files inet/getnameinfo.c and sysdeps/posix/getaddrinfo.c are copyright (C) by Craig Metz and are distributed under the following license:

/* The Inner Net License, Version 2.00

The author(s) grant permission for redistribution and use in source and binary forms, with or without modification, of the software and documentation provided that the following conditions are met:

0. If you receive a version of the software that is specifically labelled as not being for redistribution (check the version message and/or README), you are not permitted to redistribute that version of the software in any way or form.

1. All terms of the all other applicable copyrights and licenses must be followed.
2. Redistributions of source code must retain the authors' copyright notice(s), this list of conditions, and the following disclaimer.
3. Redistributions in binary form must reproduce the authors' copyright notice(s), this list of conditions, and the following disclaimer in the documentation and/or other materials provided with the distribution.
4. [The copyright holder has authorized the removal of this clause.]
5. Neither the name(s) of the author(s) nor the names of its contributors may be used to endorse or promote products derived from this software without specific prior written permission.

THIS SOFTWARE IS PROVIDED BY ITS AUTHORS AND CONTRIBUTORS "AS IS" AND ANY EXPRESS OR IMPLIED WARRANTIES, INCLUDING, BUT NOT LIMITED TO, THE IMPLIED WARRANTIES OF MERCHANTABILITY AND FITNESS FOR A PARTICULAR PURPOSE ARE DISCLAIMED. IN NO EVENT SHALL THE AUTHORS OR CONTRIBUTORS BE LIABLE FOR ANY DIRECT, INDIRECT, INCIDENTAL, SPECIAL, EXEMPLARY, OR CONSEQUENTIAL DAMAGES (INCLUDING, BUT NOT LIMITED TO, PROCUREMENT OF SUBSTITUTE GOODS OR SERVICES; LOSS OF USE, DATA, OR PROFITS; OR BUSINESS INTERRUPTION) HOWEVER CAUSED AND ON ANY THEORY OF LIABILITY, WHETHER IN CONTRACT, STRICT LIABILITY, OR TORT (INCLUDING NEGLIGENCE OR OTHERWISE) ARISING IN ANY WAY OUT OF THE USE OF THIS SOFTWARE, EVEN IF ADVISED OF THE POSSIBILITY OF SUCH DAMAGE.

If these license terms cause you a real problem, contact the author: */

The file sunrpc/des_impl.c is copyright Eric Young:

Copyright (C) 1992 Eric Young

Collected from libdes and modified for SECURE RPC by Martin Kuck 1994

This file is distributed under the terms of the GNU Lesser General Public License, version 2.1 or later - see the file COPYING.LIB for details.

If you did not receive a copy of the license with this program, please see <<http://www.gnu.org/licenses/>> to obtain a copy.

The libidn code is copyright Simon Josefsson, with portions copyright The Internet Society, Tom Tromey and Red Hat, Inc.:

Copyright (C) 2002, 2003, 2004, 2011 Simon Josefsson

This file is part of GNU Libidn.

GNU Libidn is free software; you can redistribute it and/or modify it under the terms of the GNU Lesser General Public License as published by the Free Software Foundation; either version 2.1 of the License, or (at your option) any later version.

GNU Libidn is distributed in the hope that it will be useful, but WITHOUT ANY WARRANTY; without even the implied warranty of MERCHANTABILITY or FITNESS FOR A PARTICULAR PURPOSE. See the GNU Lesser General Public License for more details.

You should have received a copy of the GNU Lesser General Public License along with GNU Libidn; if not, see <<http://www.gnu.org/licenses/>>.

The following notice applies to portions of libidn/nfkc.c:

This file contains functions from GLIB, including gutf8.c and gunicodecomp.c, all licensed under LGPL and copyright hold by:

Copyright (C) 1999, 2000 Tom Tromey

Copyright 2000 Red Hat, Inc.

The following applies to portions of libidn/punycode.c and libidn/punycode.h:

This file is derived from RFC 3492bis written by Adam M. Costello.

Disclaimer and license: Regarding this entire document or any portion of it (including the pseudocode and C code), the author makes no guarantees and is not responsible for any damage resulting from its use. The author grants irrevocable permission to anyone to use, modify, and distribute it in any way that does not diminish the rights of anyone else to use, modify, and distribute it, provided that redistributed derivative works do not contain misleading author or version information. Derivative works need not be licensed under similar terms.

Copyright (C) The Internet Society (2003). All Rights Reserved.

This document and translations of it may be copied and furnished to others, and derivative works that comment on or otherwise explain it or assist in its implementation may be prepared, copied, published and distributed, in whole or in part, without restriction of any kind, provided that the above copyright notice and this paragraph are included on all such copies and derivative works. However, this document itself may not be modified in any way, such as by removing the copyright notice or references to the Internet Society or other Internet organizations, except as needed for the purpose of developing Internet standards in which case the procedures for copyrights defined in the Internet Standards process must be followed, or as required to translate it into languages other than English.

The limited permissions granted above are perpetual and will not be revoked by the Internet Society or its successors or assigns.

This document and the information contained herein is provided on an "AS IS" basis and THE INTERNET SOCIETY AND THE INTERNET ENGINEERING TASK FORCE DISCLAIMS ALL WARRANTIES, EXPRESS OR IMPLIED, INCLUDING BUT NOT LIMITED TO ANY WARRANTY THAT THE USE OF THE INFORMATION HEREIN WILL NOT INFRINGE ANY RIGHTS OR ANY IMPLIED WARRANTIES OF MERCHANTABILITY OR FITNESS FOR A PARTICULAR PURPOSE.

The file inet/rcmd.c is under a UCB copyright and the following:

Copyright (C) 1998 WIDE Project.

All rights reserved.

Redistribution and use in source and binary forms, with or without modification, are permitted provided that the following conditions are met:

1. Redistributions of source code must retain the above copyright notice, this list of conditions and the following disclaimer.
2. Redistributions in binary form must reproduce the above copyright notice, this list of conditions and the following disclaimer in the documentation and/or other materials provided with the distribution.
3. Neither the name of the project nor the names of its contributors may be used to endorse or promote products derived from this software without specific prior written permission.

THIS SOFTWARE IS PROVIDED BY THE PROJECT AND CONTRIBUTORS "AS IS" AND ANY EXPRESS OR IMPLIED WARRANTIES, INCLUDING, BUT NOT LIMITED TO, THE IMPLIED WARRANTIES OF MERCHANTABILITY AND FITNESS FOR A PARTICULAR PURPOSE ARE DISCLAIMED. IN NO EVENT SHALL THE PROJECT OR CONTRIBUTORS BE LIABLE FOR ANY DIRECT, INDIRECT, INCIDENTAL, SPECIAL, EXEMPLARY, OR CONSEQUENTIAL DAMAGES (INCLUDING, BUT NOT LIMITED TO, PROCUREMENT OF SUBSTITUTE GOODS OR SERVICES; LOSS OF USE, DATA, OR PROFITS; OR BUSINESS INTERRUPTION) HOWEVER CAUSED AND ON ANY THEORY OF LIABILITY, WHETHER IN CONTRACT, STRICT LIABILITY, OR TORT (INCLUDING NEGLIGENCE OR OTHERWISE) ARISING

IN ANY WAY OUT OF THE USE OF THIS SOFTWARE, EVEN IF ADVISED OF THE POSSIBILITY OF SUCH DAMAGE.

The file `posix/runtests.c` is copyright Tom Lord:

Copyright 1995 by Tom Lord

All Rights Reserved

Permission to use, copy, modify, and distribute this software and its documentation for any purpose and without fee is hereby granted, provided that the above copyright notice appear in all copies and that both that copyright notice and this permission notice appear in supporting documentation, and that the name of the copyright holder not be used in advertising or publicity pertaining to distribution of the software without specific, written prior permission.

Tom Lord DISCLAIMS ALL WARRANTIES WITH REGARD TO THIS SOFTWARE, INCLUDING ALL IMPLIED WARRANTIES OF MERCHANTABILITY AND FITNESS, IN NO EVENT SHALL TOM LORD BE LIABLE FOR ANY SPECIAL, INDIRECT OR CONSEQUENTIAL DAMAGES OR ANY DAMAGES WHATSOEVER RESULTING FROM LOSS OF USE, DATA OR PROFITS, WHETHER IN AN ACTION OF CONTRACT, NEGLIGENCE OR OTHER TORTIOUS ACTION, ARISING OUT OF OR IN CONNECTION WITH THE USE OR PERFORMANCE OF THIS SOFTWARE.

The `posix/rxspencer` tests are copyright Henry Spencer:

Copyright 1992, 1993, 1994, 1997 Henry Spencer. All rights reserved.

This software is not subject to any license of the American Telephone and Telegraph Company or of the Regents of the University of California.

Permission is granted to anyone to use this software for any purpose on any computer system, and to alter it and redistribute it, subject to the following restrictions:

1. The author is not responsible for the consequences of use of this software, no matter how awful, even if they arise from flaws in it.
2. The origin of this software must not be misrepresented, either by explicit claim or by omission. Since few users ever read sources, credits must appear in the documentation.
3. Altered versions must be plainly marked as such, and must not be misrepresented as being the original software. Since few users ever read sources, credits must appear in the documentation.
4. This notice may not be removed or altered.

The file `posix/PCRE.tests` is copyright University of Cambridge:

Copyright (c) 1997-2003 University of Cambridge

Permission is granted to anyone to use this software for any purpose on any computer system, and to redistribute it freely, subject to the following restrictions:

1. This software is distributed in the hope that it will be useful, but WITHOUT ANY WARRANTY; without even the implied warranty of MERCHANTABILITY or FITNESS FOR A PARTICULAR PURPOSE.
2. The origin of this software must not be misrepresented, either by explicit claim or by omission. In practice, this means that if you use PCRE in software that you distribute to others, commercially or otherwise, you must put a sentence like this Regular expression support is provided by the PCRE library package, which is open source software, written by Philip Hazel, and copyright by the University of Cambridge, England.

somewhere reasonably visible in your documentation and in any relevant files or online help data or similar: A reference to the ftp site for the source, that is, to

`ftp://ftp.csx.cam.ac.uk/pub/software/programming/pcre/`

should also be given in the documentation. However, this condition is not intended to apply to whole chains of software. If package A includes PCRE, it must acknowledge it, but if package B is software

that includes package A, the condition is not imposed on package B (unless it uses PCRE independently).

3. Altered versions must be plainly marked as such, and must not be misrepresented as being the original software.
4. If PCRE is embedded in any software that is released under the GNU General Purpose Licence (GPL), or Lesser General Purpose Licence (LGPL), then the terms of that licence shall supersede any condition above with which it is incompatible.

Files from Sun `fdlibm` are copyright Sun Microsystems, Inc.:

Copyright (C) 1993 by Sun Microsystems, Inc. All rights reserved.

Developed at SunPro, a Sun Microsystems, Inc. business. Permission to use, copy, modify, and distribute this software is freely granted, provided that this notice is preserved.

Part of `stdio-common/tst-print.c` is copyright C E Chew:

(C) Copyright C E Chew

Feel free to copy, use and distribute this software provided:

1. you do not pretend that you wrote it
2. you leave this copyright notice intact.

Various long double `libm` functions are copyright Stephen L. Moshier:

Copyright 2001 by Stephen L. Moshier <moshier@na-net.ornl.gov>

This library is free software; you can redistribute it and/or modify it under the terms of the GNU Lesser General Public License as published by the Free Software Foundation; either version 2.1 of the License, or (at your option) any later version.

This library is distributed in the hope that it will be useful, but WITHOUT ANY WARRANTY; without even the implied warranty of MERCHANTABILITY or FITNESS FOR A PARTICULAR PURPOSE. See the GNU Lesser General Public License for more details.

You should have received a copy of the GNU Lesser General Public License along with this library; if not, see <<http://www.gnu.org/licenses/>>. */

13. gcc libgcc and gcc libstdc++

GNU GENERAL PUBLIC LICENSE

Version 3, 29 June 2007

Copyright (C) 2007 Free Software Foundation, Inc. <<http://fsf.org/>>

Everyone is permitted to copy and distribute verbatim copies of this license document, but changing it is not allowed.

Preamble

The GNU General Public License is a free, copyleft license for software and other kinds of works.

The licenses for most software and other practical works are designed to take away your freedom to share and change the works. By contrast, the GNU General Public License is intended to guarantee your freedom to share and change all versions of a program—to make sure it remains free software for all its users. We, the Free Software Foundation, use the GNU General Public License for most of our software; it applies also to any other work released this way by its authors. You can apply it to your programs, too.

When we speak of free software, we are referring to freedom, not price. Our General Public Licenses are designed to make sure that you have the freedom to distribute copies of free software (and charge for them if you wish), that you receive source code or can get it if you want it, that you can change the software or use pieces of it in new free programs, and that you know you can do these things.

To protect your rights, we need to prevent others from denying you these rights or asking you to surrender the rights. Therefore, you have certain responsibilities if you distribute copies of the software, or if you modify it: responsibilities to respect the freedom of others.

For example, if you distribute copies of such a program, whether gratis or for a fee, you must pass on to the recipients the same freedoms that you received. You must make sure that they, too, receive or can get the source code. And you must show them these terms so they know their rights.

Developers that use the GNU GPL protect your rights with two steps: (1) assert copyright on the software, and (2) offer you this License giving you legal permission to copy, distribute and/or modify it.

For the developers' and authors' protection, the GPL clearly explains that there is no warranty for this free software. For both users' and authors' sake, the GPL requires that modified versions be marked as changed, so that their problems will not be attributed erroneously to authors of previous versions.

Some devices are designed to deny users access to install or run modified versions of the software inside them, although the manufacturer can do so. This is fundamentally incompatible with the aim of protecting users' freedom to change the software. The systematic pattern of such abuse occurs in the area of products for individuals to use, which is precisely where it is most unacceptable. Therefore, we have designed this version of the GPL to prohibit the practice for those products. If such problems arise substantially in other domains, we stand ready to extend this provision to those domains in future versions of the GPL, as needed to protect the freedom of users.

Finally, every program is threatened constantly by software patents. States should not allow patents to restrict development and use of software on general-purpose computers, but in those that do, we wish to avoid the special danger that patents applied to a free program could make it effectively proprietary. To prevent this, the GPL assures that patents cannot be used to render the program non-free.

The precise terms and conditions for copying, distribution and modification follow.

TERMS AND CONDITIONS

0. Definitions.

"This License" refers to version 3 of the GNU General Public License.

"Copyright" also means copyright-like laws that apply to other kinds of works, such as semiconductor masks.

"The Program" refers to any copyrightable work licensed under this License. Each licensee is addressed as "you", "Licensees" and "recipients" may be individuals or organizations.

To "modify" a work means to copy from or adapt all or part of the work in a fashion requiring copyright permission, other than the making of an exact copy. The resulting work is called a "modified version" of the earlier work or a work "based on" the earlier work.

A "covered work" means either the unmodified Program or a work based on the Program.

To "propagate" a work means to do anything with it that, without permission, would make you directly or secondarily liable for infringement under applicable copyright law, except executing it on a computer or modifying a private copy. Propagation includes copying, distribution (with or without modification), making available to the public, and in some countries other activities as well.

To "convey" a work means any kind of propagation that enables other parties to make or receive copies. Mere interaction with a user through a computer network, with no transfer of a copy, is not conveying.

An interactive user interface displays "Appropriate Legal Notices" to the extent that it includes a convenient and prominently visible feature that (1) displays an appropriate copyright notice, and (2) tells the user that there is no warranty for the work (except to the extent that warranties are provided), that licensees may convey the work under this License, and how to view a copy of this License. If the interface presents a list of user commands or options, such as a menu, a prominent item in the list meets this criterion.

1. Source Code.

The "source code" for a work means the preferred form of the work for making modifications to it. "Object code" means any non-source form of a work.

A "Standard Interface" means an interface that either is an official standard defined by a recognized standards body, or, in the case of interfaces specified for a particular programming language, one that is widely used among developers working in that language.

The "System Libraries" of an executable work include anything, other than the work as a whole, that (a) is included in the normal form of packaging a Major Component, but which is not part of that Major Component, and (b) serves only to enable use of the work with that Major Component, or to implement a Standard Interface for which an implementation is available to the public in source code form. A "Major Component", in this context, means a major essential component (kernel, window system, and so on) of the specific operating system (if any) on which the executable work runs, or a compiler used to produce the work, or an object code interpreter used to run it.

The "Corresponding Source" for a work in object code form means all the source code needed to generate, install, and (for an executable work) run the object code and to modify the work, including scripts to control those activities. However, it does not include the work's System Libraries, or general-purpose tools or generally available free programs which are used unmodified in performing those activities but which are not part of the work. For example, Corresponding Source includes interface definition files associated with source files for the work, and the source code for shared libraries and dynamically linked subprograms that the work is specifically designed to require, such as by intimate data communication or control flow between those subprograms and other parts of the work.

The Corresponding Source need not include anything that users can regenerate automatically from other parts of the Corresponding Source.

The Corresponding Source for a work in source code form is that same work.

2. Basic Permissions.

All rights granted under this License are granted for the term of copyright on the Program, and are irrevocable provided the stated conditions are met. This License explicitly affirms your unlimited permission to run the unmodified Program. The output from running a covered work is covered by this License only if the output, given its content, constitutes a covered work. This License acknowledges your rights of fair use or other equivalent, as provided by copyright law.

You may make, run and propagate covered works that you do not convey, without conditions so long as your license otherwise remains in force. You may convey covered works to others for the sole purpose of having them make modifications exclusively for you, or provide you with facilities for running those works, provided that you comply with the terms of this License in conveying all material for which you do not control copyright. Those thus making or running the covered works for you must do so exclusively on your behalf, under your direction and control, on terms that prohibit them from making any copies of your copyrighted material outside their relationship with you.

Conveying under any other circumstances is permitted solely under the conditions stated below. Sublicensing is not allowed; section 10 makes it unnecessary.

3. Protecting Users' Legal Rights From Anti-Circumvention Law.

No covered work shall be deemed part of an effective technological measure under any applicable law fulfilling obligations under article 11 of the WIPO copyright treaty adopted on 20 December 1996, or similar laws prohibiting or restricting circumvention of such measures. When you convey a covered work, you waive any legal power to forbid circumvention of technological measures to the extent such circumvention is effected by exercising rights under this License with respect to the covered work, and you disclaim any intention to

limit operation or modification of the work as a means of enforcing against the work's users, your or third parties' legal rights to forbid circumvention of technological measures.

4. Conveying Verbatim Copies.

You may convey verbatim copies of the Program's source code as you receive it, in any medium, provided that you conspicuously and appropriately publish on each copy an appropriate copyright notice; keep intact all notices stating that this License and any non-permissive terms added in accord with section 7 apply to the code; keep intact all notices of the absence of any warranty; and give all recipients a copy of this License along with the Program.

You may charge any price or no price for each copy that you convey, and you may offer support or warranty protection for a fee.

5. Conveying Modified Source Versions.

You may convey a work based on the Program, or the modifications to produce it from the Program, in the form of source code under the terms of section 4, provided that you also meet all of these conditions:

- a) The work must carry prominent notices stating that you modified it, and giving a relevant date.
- b) The work must carry prominent notices stating that it is released under this License and any conditions added under section 7. This requirement modifies the requirement in section 4 to "keep intact all notices".
- c) You must license the entire work, as a whole, under this License to anyone who comes into possession of a copy. This License will therefore apply, along with any applicable section 7 additional terms, to the whole of the work, and all its parts, regardless of how they are packaged. This License gives no permission to license the work in any other way, but it does not invalidate such permission if you have separately received it.
- d) If the work has interactive user interfaces, each must display Appropriate Legal Notices; however, if the Program has interactive interfaces that do not display Appropriate Legal Notices, your work need not make them do so.

A compilation of a covered work with other separate and independent works, which are not by their nature extensions of the covered work, and which are not combined with it such as to form a larger program, in or on a volume of a storage or distribution medium, is called an "aggregate" if the compilation and its resulting copyright are not used to limit the access or legal rights of the compilation's users beyond what the individual works permit. Inclusion of a covered work in an aggregate does not cause this License to apply to the other parts of the aggregate.

6. Conveying Non-Source Forms.

You may convey a covered work in object code form under the terms of sections 4 and 5, provided that you also convey the machine-readable Corresponding Source under the terms of this License, in one of these ways:

- a) Convey the object code in, or embodied in, a physical product (including a physical distribution medium), accompanied by the Corresponding Source fixed on a durable physical medium customarily used for software interchange.
- b) Convey the object code in, or embodied in, a physical product (including a physical distribution medium), accompanied by a written offer, valid for at least three years and valid for as long as you offer spare parts or customer support for that product model, to give anyone who possesses the object code either (1) a copy of the Corresponding Source for all the software in the product that is covered by this License, on a durable physical medium customarily used for software interchange, for a price no more than your reasonable cost of physically performing this conveying of source, or (2) access to copy the Corresponding Source from a network server at no charge.

c) Convey individual copies of the object code with a copy of the written offer to provide the Corresponding Source. This alternative is allowed only occasionally and noncommercially, and only if you received the object code with such an offer, in accord with subsection 6b.

d) Convey the object code by offering access from a designated place (gratis or for a charge), and offer equivalent access to the Corresponding Source in the same way through the same place at no further charge. You need not require recipients to copy the Corresponding Source along with the object code. If the place to copy the object code is a network server, the Corresponding Source may be on a different server (operated by you or a third party) that supports equivalent copying facilities, provided you maintain clear directions next to the object code saying where to find the Corresponding Source. Regardless of what server hosts the Corresponding Source, you remain obligated to ensure that it is available for as long as needed to satisfy these requirements.

e) Convey the object code using peer-to-peer transmission, provided you inform other peers where the object code and Corresponding Source of the work are being offered to the general public at no charge under subsection 6d.

A separable portion of the object code, whose source code is excluded from the Corresponding Source as a System Library, need not be included in conveying the object code work.

A "User Product" is either (1) a "consumer product", which means any tangible personal property which is normally used for personal, family, or household purposes, or (2) anything designed or sold for incorporation into a dwelling. In determining whether a product is a consumer product, doubtful cases shall be resolved in favor of coverage. For a particular product received by a particular user, "normally used" refers to a typical or common use of that class of product, regardless of the status of the particular user or of the way in which the particular user actually uses, or expects or is expected to use, the product. A product is a consumer product regardless of whether the product has substantial commercial, industrial or non-consumer uses, unless such uses represent the only significant mode of use of the product.

"Installation Information" for a User Product means any methods, procedures, authorization keys, or other information required to install and execute modified versions of a covered work in that User Product from a modified version of its Corresponding Source. The information must suffice to ensure that the continued functioning of the modified object code is in no case prevented or interfered with solely because modification has been made.

If you convey an object code work under this section in, or with, or specifically for use in, a User Product, and the conveying occurs as part of a transaction in which the right of possession and use of the User Product is transferred to the recipient in perpetuity or for a fixed term (regardless of how the transaction is characterized), the Corresponding Source conveyed under this section must be accompanied by the Installation Information. But this requirement does not apply if neither you nor any third party retains the ability to install modified object code on the User Product (for example, the work has been installed in ROM).

The requirement to provide Installation Information does not include a requirement to continue to provide support service, warranty, or updates for a work that has been modified or installed by the recipient, or for the User Product in which it has been modified or installed. Access to a network may be denied when the modification itself materially and adversely affects the operation of the network or violates the rules and protocols for communication across the network. Corresponding Source conveyed, and Installation Information provided, in accord with this section must be in a format that is publicly documented (and with an implementation available to the public in source code form), and must require no special password or key for unpacking, reading or copying.

7. Additional Terms.

“Additional permissions” are terms that supplement the terms of this License by making exceptions from one or more of its conditions. Additional permissions that are applicable to the entire Program shall be treated as though they were included in this License, to the extent that they are valid under applicable law. If additional permissions apply only to part of the Program, that part may be used separately under those permissions, but the entire Program remains governed by this License without regard to the additional permissions.

When you convey a copy of a covered work, you may at your option remove any additional permissions from that copy, or from any part of it. (Additional permissions may be written to require their own removal in certain cases when you modify the work.) You may place additional permissions on material, added by you to a covered work, for which you have or can give appropriate copyright permission.

Notwithstanding any other provision of this License, for material you add to a covered work, you may (if authorized by the copyright holders of that material) supplement the terms of this License with terms:

- a) Disclaiming warranty or limiting liability differently from the terms of sections 15 and 16 of this License; or
- b) Requiring preservation of specified reasonable legal notices or author attributions in that material or in the Appropriate Legal Notices displayed by works containing it; or
- c) Prohibiting misrepresentation of the origin of that material, or requiring that modified versions of such material be marked in reasonable ways as different from the original version; or
- d) Limiting the use for publicity purposes of names of licensors or authors of the material; or
- e) Declining to grant rights under trademark law for use of some trade names, trademarks, or service marks; or
- f) Requiring indemnification of licensors and authors of that material by anyone who conveys the material (or modified versions of it) with contractual assumptions of liability to the recipient, for any liability that these contractual assumptions directly impose on those licensors and authors.

All other non-permissive additional terms are considered “further restrictions” within the meaning of section 10. If the Program as you received it, or any part of it, contains a notice stating that it is governed by this License along with a term that is a further restriction, you may remove that term. If a license document contains a further restriction but permits relicensing or conveying under this License, you may add to a covered work material governed by the terms of that license document, provided that the further restriction does not survive such relicensing or conveying.

If you add terms to a covered work in accord with this section, you must place, in the relevant source files, a statement of the additional terms that apply to those files, or a notice indicating where to find the applicable terms.

Additional terms, permissive or non-permissive, may be stated in the form of a separately written license, or stated as exceptions; the above requirements apply either way.

8. Termination.

You may not propagate or modify a covered work except as expressly provided under this License. Any attempt otherwise to propagate or modify it is void, and will automatically terminate your rights under this License (including any patent licenses granted under the third paragraph of section 11).

However, if you cease all violation of this License, then your license from a particular copyright holder is reinstated (a) provisionally, unless and until the copyright holder explicitly and finally terminates your license, and (b) permanently, if the copyright holder fails to notify you of the violation by some reasonable means prior to 60 days after the cessation.

Moreover, your license from a particular copyright holder is reinstated permanently if the copyright holder notifies you of the violation by some reasonable means, this is the first time you have received notice of violation of this License (for any work) from that copyright holder; and you cure the violation prior to 30 days after your receipt of the notice.

Termination of your rights under this section does not terminate the licenses of parties who have received copies or rights from you under this License. If your rights have been terminated and not permanently reinstated, you do not qualify to receive new licenses for the same material under section 10.

9. Acceptance Not Required for Having Copies.

You are not required to accept this License in order to receive or run a copy of the Program. Ancillary propagation of a covered work occurring solely as a consequence of using peer-to-peer transmission to receive a copy likewise does not require acceptance. However, nothing other than this License grants you permission to propagate or modify any covered work. These actions infringe copyright if you do not accept this License. Therefore, by modifying or propagating a covered work, you indicate your acceptance of this License to do so.

10. Automatic Licensing of Downstream Recipients.

Each time you convey a covered work, the recipient automatically receives a license from the original licensors, to run, modify and propagate that work, subject to this License. You are not responsible for enforcing compliance by third parties with this License.

An “entity transaction” is a transaction transferring control of an organization, or substantially all assets of one, or subdividing an organization, or merging organizations. If propagation of a covered work results from an entity transaction, each party to that transaction who receives a copy of the work also receives whatever licenses to the work the party’s predecessor in interest had or could give under the previous paragraph, plus a right to possession of the Corresponding Source of the work from the predecessor in interest, if the predecessor has it or can get it with reasonable efforts.

You may not impose any further restrictions on the exercise of the rights granted or affirmed under this License. For example, you may not impose a license fee, royalty, or other charge for exercise of rights granted under this License, and you may not initiate litigation (including a cross-claim or counterclaim in a lawsuit) alleging that any patent claim is infringed by making, using, selling, offering for sale, or importing the Program or any portion of it.

11. Patents.

A “contributor” is a copyright holder who authorizes use under this License of the Program or a work on which the Program is based. The work thus licensed is called the contributor’s “contributor version”.

A contributor’s “essential patent claims” are all patent claims owned or controlled by the contributor, whether already acquired or hereafter acquired, that would be infringed by some manner, permitted by this License, of making, using, or selling its contributor version, but do not include claims that would be infringed only as a consequence of further modification of the contributor version. For purposes of this definition, “control” includes the right to grant patent sublicenses in a manner consistent with the requirements of this License.

Each contributor grants you a non-exclusive, worldwide, royalty-free patent license under the contributor’s essential patent claims, to make, use, sell, offer for sale, import and otherwise run, modify and propagate the contents of its contributor version.

In the following three paragraphs, a “patent license” is any express agreement or commitment, however denominated, not to enforce a patent (such as an express permission to practice a patent or covenant not to sue for patent infringement). To “grant” such a patent license to a party means to make such an agreement or commitment not to enforce a patent against the party.

If you convey a covered work, knowingly relying on a patent license, and the Corresponding Source of the work is not available for anyone

to copy, free of charge and under the terms of this License, through a publicly available network server or other readily accessible means, then you must either (1) cause the Corresponding Source to be so available, or (2) arrange to deprive yourself of the benefit of the patent license for this particular work, or (3) arrange, in a manner consistent with the requirements of this License, to extend the patent license to downstream recipients. "Knowingingly relying" means you have actual knowledge that, but for the patent license, your conveying the covered work in a country, or your recipient's use of the covered work in a country, would infringe one or more identifiable patents in that country that you have reason to believe are valid.

If, pursuant to or in connection with a single transaction or arrangement, you convey, or propagate by procuring conveyance of, a covered work, and grant a patent license to some of the parties receiving the covered work authorizing them to use, propagate, modify or convey a specific copy of the covered work, then the patent license you grant is automatically extended to all recipients of the covered work and works based on it.

A patent license is "discriminatory" if it does not include within the scope of its coverage, prohibits the exercise of, or is conditioned on the non-exercise of one or more of the rights that are specifically granted under this License. You may not convey a covered work if you are a party to an arrangement with a third party that is in the business of distributing software, under which you make payment to the third party based on the extent of your activity of conveying the work, and under which the third party grants, to any of the parties who would receive the covered work from you, a discriminatory patent license (a) in connection with copies of the covered work conveyed by you (or copies made from those copies), or (b) primarily for and in connection with specific products or compilations that contain the covered work, unless you entered into that arrangement, or that patent license was granted, prior to 28 March 2007.

Nothing in this License shall be construed as excluding or limiting any implied license or other defenses to infringement that may otherwise be available to you under applicable patent law.

12. No Surrender of Others' Freedom.

If conditions are imposed on you (whether by court order, agreement or otherwise) that contradict the conditions of this License, they do not excuse you from the conditions of this License. If you cannot convey a covered work so as to satisfy simultaneously your obligations under this License and any other pertinent obligations, then as a consequence you may not convey it at all. For example, if you agree to terms that obligate you to collect a royalty for further conveying from those to whom you convey the Program, the only way you could satisfy both those terms and this License would be to refrain entirely from conveying the Program.

13. Use with the GNU Affero General Public License.

Notwithstanding any other provision of this License, you have permission to link or combine any covered work with a work licensed under version 3 of the GNU Affero General Public License into a single combined work, and to convey the resulting work. The terms of this License will continue to apply to the part which is the covered work, but the special requirements of the GNU Affero General Public License, section 13, concerning interaction through a network will apply to the combination as such.

14. Revised Versions of this License.

The Free Software Foundation may publish revised and/or new versions of the GNU General Public License from time to time. Such new versions will be similar in spirit to the present version, but may differ in detail to address new problems or concerns.

Each version is given a distinguishing version number. If the Program specifies that a certain numbered version of the GNU General Public License "or any later version" applies to it, you have the option of following the terms and conditions either of that numbered version

or of any later version published by the Free Software Foundation. If the Program does not specify a version number of the GNU General Public License, you may choose any version ever published by the Free Software Foundation.

If the Program specifies that a proxy can decide which future versions of the GNU General Public License can be used, that proxy's public statement of acceptance of a version permanently authorizes you to choose that version for the Program.

Later license versions may give you additional or different permissions. However, no additional obligations are imposed on any author or copyright holder as a result of your choosing to follow a later version.

15. Disclaimer of Warranty.

THERE IS NO WARRANTY FOR THE PROGRAM, TO THE EXTENT PERMITTED BY APPLICABLE LAW. EXCEPT WHEN OTHERWISE STATED IN WRITING THE COPYRIGHT HOLDERS AND/OR OTHER PARTIES PROVIDE THE PROGRAM "AS IS" WITHOUT WARRANTY OF ANY KIND, EITHER EXPRESSED OR IMPLIED, INCLUDING, BUT NOT LIMITED TO, THE IMPLIED WARRANTIES OF MERCHANTABILITY AND FITNESS FOR A PARTICULAR PURPOSE. THE ENTIRE RISK AS TO THE QUALITY AND PERFORMANCE OF THE PROGRAM IS WITH YOU. SHOULD THE PROGRAM PROVE DEFECTIVE, YOU ASSUME THE COST OF ALL NECESSARY SERVICING, REPAIR OR CORRECTION.

16. Limitation of Liability.

IN NO EVENT UNLESS REQUIRED BY APPLICABLE LAW OR AGREED TO IN WRITING WILL ANY COPYRIGHT HOLDER, OR ANY OTHER PARTY WHO MODIFIES AND/OR CONVEYS THE PROGRAM AS PERMITTED ABOVE, BE LIABLE TO YOU FOR DAMAGES, INCLUDING ANY GENERAL, SPECIAL, INCIDENTAL OR CONSEQUENTIAL DAMAGES ARISING OUT OF THE USE OR INABILITY TO USE THE PROGRAM (INCLUDING BUT NOT LIMITED TO LOSS OF DATA OR DATA BEING RENDERED INACCURATE OR LOSSES SUSTAINED BY YOU OR THIRD PARTIES OR A FAILURE OF THE PROGRAM TO OPERATE WITH ANY OTHER PROGRAMS), EVEN IF SUCH HOLDER OR OTHER PARTY HAS BEEN ADVISED OF THE POSSIBILITY OF SUCH DAMAGES.

17. Interpretation of Sections 15 and 16.

If the disclaimer of warranty and limitation of liability provided above cannot be given local legal effect according to their terms, reviewing courts shall apply local law that most closely approximates an absolute waiver of all civil liability in connection with the Program, unless a warranty or assumption of liability accompanies a copy of the Program in return for a fee.

END OF TERMS AND CONDITIONS

How to Apply These Terms to Your New Programs

If you develop a new program, and you want it to be of the greatest possible use to the public, the best way to achieve this is to make it free software which everyone can redistribute and change under these terms.

To do so, attach the following notices to the program. It is safest to attach them to the start of each source file to most effectively state the exclusion of warranty; and each file should have at least the "copyright" line and a pointer to where the full notice is found.

<one line to give the program's name and a brief idea of what it does.>
Copyright (C) <year> <name of author>

This program is free software: you can redistribute it and/or modify it under the terms of the GNU General Public License as published by the Free Software Foundation, either version 3 of the License, or (at your option) any later version.

This program is distributed in the hope that it will be useful, but WITHOUT ANY WARRANTY; without even the implied warranty of MERCHANTABILITY or FITNESS FOR A PARTICULAR PURPOSE. See the GNU General Public License for more details.

You should have received a copy of the GNU General Public License along with this program. If not, see <<http://www.gnu.org/licenses/>>.

Also add information on how to contact you by electronic and paper mail.

If the program does terminal interaction, make it output a short notice like this when it starts in an interactive mode:

```
<program> Copyright (C) <year> <name of author> This program
comes with ABSOLUTELY NO WARRANTY; for details type `show
w'. This is free software, and you are welcome to redistribute it under
certain conditions; type `show c' for details.
```

The hypothetical commands `show w' and `show c' should show the appropriate parts of the General Public License. Of course, your program's commands might be different; for a GUI interface, you would use an "about box".

You should also get your employer (if you work as a programmer) or school, if any, to sign a "copyright disclaimer" for the program, if necessary. For more information on this, and how to apply and follow the GNU GPL, see <<http://www.gnu.org/licenses/>>.

The GNU General Public License does not permit incorporating your program into proprietary programs. If your program is a subroutine library, you may consider it more useful to permit linking proprietary applications with the library. If this is what you want to do, use the GNU Lesser General Public License instead of this License. But first, please read <<http://www.gnu.org/philosophy/why-not-lgpl.html>>.

GCC RUNTIME LIBRARY EXCEPTION

Version 3.1, 31 March 2009 Copyright (C) 2009 Free Software Foundation, Inc. <<http://fsf.org/>> Everyone is permitted to copy and distribute verbatim copies of this license document, but changing it is not allowed.

This GCC Runtime Library Exception ("Exception") is an additional permission under section 7 of the GNU General Public License, version 3 ("GPLv3"). It applies to a given file (the "Runtime Library") that bears a notice placed by the copyright holder of the file stating that the file is governed by GPLv3 along with this Exception.

When you use GCC to compile a program, GCC may combine portions of certain GCC header files and runtime libraries with the compiled program. The purpose of this Exception is to allow compilation of non-GPL (including proprietary) programs to use, in this way, the header files and runtime libraries covered by this Exception.

0. Definitions.

A file is an "Independent Module" if it either requires the Runtime Library for execution after a Compilation Process, or makes use of an interface provided by the Runtime Library, but is not otherwise based on the Runtime Library.

"GCC" means a version of the GNU Compiler Collection, with or without modifications, governed by version 3 (or a specified later version) of the GNU General Public License (GPL) with the option of using any subsequent versions published by the FSF.

"GPL-compatible Software" is software whose conditions of propagation, modification and use would permit combination with GCC in accord with the license of GCC. "Target Code" refers to output from any compiler for a real or virtual target processor architecture, in executable form or suitable for input to an assembler, loader, linker and/or execution phase. Notwithstanding that, Target Code does not include data in any format that is used as a compiler intermediate representation, or used for producing a compiler intermediate representation.

The "Compilation Process" transforms code entirely represented in non-intermediate languages designed for human-written code, and/or in Java Virtual Machine byte code, into Target Code. Thus, for example, use of source code generators and preprocessors need not be considered part of the Compilation Process, since the Compilation Process

can be understood as starting with the output of the generators or preprocessors.

A Compilation Process is "Eligible" if it is done using GCC, alone or with other GPL-compatible software, or if it is done without using any work based on GCC. For example, using non-GPL-compatible Software to optimize any GCC intermediate representations would not qualify as an Eligible Compilation Process.

1. Grant of Additional Permission.

You have permission to propagate a work of Target Code formed by combining the Runtime Library with Independent Modules, even if such propagation would otherwise violate the terms of GPLv3, provided that all Target Code was generated by Eligible Compilation Processes. You may then convey such a combination under terms of your choice, consistent with the licensing of the Independent Modules.

2. No Weakening of GCC Copyleft.

The availability of this Exception does not imply any general presumption that third-party software is unaffected by the copyleft requirements of the license of GCC.

14. ntpdate 4.2.6

The following copyright notice applies to all files collectively called the Network Time Protocol Version 4 Distribution. Unless specifically declared otherwise in an individual file, this notice applies as if the text was explicitly included in the file.

```
*****
*
* Copyright (c) University of Delaware 1992-2011
*
* Permission to use, copy, modify, and distribute this software and
* its documentation for any purpose with or without fee is hereby
* granted, provided that the above copyright notice appears in all
* copies and that both the copyright notice and this permission
* notice appear in supporting documentation, and that the name
* University of Delaware not be used in advertising or publicity
* pertaining to distribution of the software without specific,
* written prior permission. The University of Delaware makes no
* representations about the suitability this software for any
* purpose. It is provided "as is" without express or implied
* warranty.
*
*****
```

15. libtom

LibTomCrypt is public domain. As should all quality software be.
-- Tom St Denis

LibTomMath is hereby released into the Public Domain.
-- Tom St Denis

16. c-ares

```
/*
 * Copyright 1998 by the Massachusetts Institute of Technology.
 * Copyright (C) 2007-2013 by Daniel Stenberg Permission to use,
 * copy, modify, and distribute this software and its documentation for
 * any purpose and without fee is hereby granted, provided that
 * the above copyright notice appear in all copies and that both that
 * copyright notice and this permission notice appear in supporting
 * documentation, and that the name of M.I.T. not be used in
 * advertising or publicity pertaining to distribution of the software
 * without specific, written prior permission. M.I.T. makes no
 * representations about the suitability of this software for any
 * purpose. It is provided "as is" without express or implied warranty.
 */
```

17. cJSON

Copyright (c) 2009 Dave Gamble

Permission is hereby granted, free of charge, to any person obtaining a copy of this software and associated documentation files (the "Software"), to deal in the Software without restriction, including without limitation the rights to use, copy, modify, merge, publish, distribute, sublicense, and/or sell copies of the Software, and to permit persons to whom the Software is furnished to do so, subject to the following conditions:

The above copyright notice and this permission notice shall be included in all copies or substantial portions of the Software.

THE SOFTWARE IS PROVIDED "AS IS", WITHOUT WARRANTY OF ANY KIND, EXPRESS OR IMPLIED, INCLUDING BUT NOT LIMITED TO THE WARRANTIES OF MERCHANTABILITY, FITNESS FOR A PARTICULAR PURPOSE AND NONINFRINGEMENT. IN NO EVENT SHALL THE AUTHORS OR COPYRIGHT HOLDERS BE LIABLE FOR ANY CLAIM, DAMAGES OR OTHER LIABILITY, WHETHER IN AN ACTION OF CONTRACT, TORT OR OTHERWISE, ARISING FROM, OUT OF OR IN CONNECTION WITH THE SOFTWARE OR THE USE OR OTHER DEALINGS IN THE SOFTWARE.

18. cURL

COPYRIGHT AND PERMISSION NOTICE

Copyright (c) 1996 - 2013, Daniel Stenberg, <daniel@haxx.se>. All rights reserved.

Permission to use, copy, modify, and distribute this software for any purpose with or without fee is hereby granted, provided that the above copyright notice and this permission notice appear in all copies.

THE SOFTWARE IS PROVIDED "AS IS", WITHOUT WARRANTY OF ANY KIND, EXPRESS OR IMPLIED, INCLUDING BUT NOT LIMITED TO THE WARRANTIES OF MERCHANTABILITY, FITNESS FOR A PARTICULAR PURPOSE AND NONINFRINGEMENT OF THIRD PARTY RIGHTS. IN NO EVENT SHALL THE AUTHORS OR COPYRIGHT HOLDERS BE LIABLE FOR ANY CLAIM, DAMAGES OR OTHER LIABILITY, WHETHER IN AN ACTION OF CONTRACT, TORT OR OTHERWISE, ARISING FROM, OUT OF OR IN CONNECTION WITH THE SOFTWARE OR THE USE OR OTHER DEALINGS IN THE SOFTWARE.

Except as contained in this notice, the name of a copyright holder shall not be used in advertising or otherwise to promote the sale, use or other dealings in this Software without prior written authorization of the copyright holder.

19. dhcpcd

/* The dhcpcd-pools has BSD 2-clause license which also known as "Simplified BSD License" or "FreeBSD License". Copyright 2006-Sami Kerola. All rights reserved. Redistribution and use in source and binary forms, with or without modification, are permitted provided that the following conditions are met: 1. Redistributions of source code must retain the above copyright notice, this list of conditions and the following disclaimer.

* 2. Redistributions in binary form must reproduce the above copyright notice, this list of conditions and the following disclaimer in the documentation and/or other materials provided with the distribution.

* THIS SOFTWARE IS PROVIDED BY THE AUTHOR AND CONTRIBUTORS "AS IS" AND ANY EXPRESS OR IMPLIED WARRANTIES, INCLUDING, BUT NOT LIMITED TO, THE IMPLIED WARRANTIES OF MERCHANTABILITY AND FITNESS FOR A PARTICULAR PURPOSE ARE DISCLAIMED. IN NO EVENT SHALL THE AUTHOR AND CONTRIBUTORS OR CONTRIBUTORS BE LIABLE FOR ANY DIRECT, INDIRECT,

INCIDENTAL, SPECIAL, EXEMPLARY, OR CONSEQUENTIAL DAMAGES (INCLUDING, BUT NOT LIMITED TO, PROCUREMENT OF SUBSTITUTE GOODS OR SERVICES; LOSS OF USE, DATA, OR PROFITS; OR BUSINESS INTERRUPTION) HOWEVER CAUSED AND ON ANY THEORY OF LIABILITY, WHETHER IN CONTRACT, STRICT LIABILITY, OR TORT (INCLUDING NEGLIGENCE OR OTHERWISE) ARISING IN ANY WAY OUT OF THE USE OF THIS SOFTWARE, EVEN IF ADVISED OF THE POSSIBILITY OF SUCH DAMAGE.

* The views and conclusions contained in the software and documentation are those of the authors and should not be interpreted as representing official policies, either expressed or implied, of Sami Kerola.

*/

20. goahead

The Software contains third party software under the agreements that follow.

EST License

The optional EST SSL stack includes code from TropicSSL.

TropicSSL - [BSD License](<http://opensource.org/licenses/BSD-2-Clause>)

RSA MD5 License

License to copy and use this software is granted provided that it is identified as the "RSA Data Security, Inc. MD5 Message-Digest Algorithm" in all material mentioning or referencing this software or this function. License is also granted to make and use derivative works provided that such works are identified as "derived from the RSA Data Security, Inc. MD5 Message-Digest Algorithm" in all material mentioning or referencing the derived work. RSA Data Security, Inc. makes no representations concerning either the merchantability of this software or the suitability of this software for any particular purpose. It is provided "as is" without express or implied warranty of any kind. These notices must be retained in any copies of any part of this documentation and/or software.

21. Mongoose

Copyright (c) 2004-2013 Sergey Lyubka <valenok@gmail.com>

Copyright (c) 2013-2015 Cesanta Software Limited

All rights reserved

This code is dual-licensed: you can redistribute it and/or modify it under the terms of the GNU General Public License version 2 as published by the Free Software Foundation. For the terms of this license, see <<http://www.gnu.org/licenses>>.

You are free to use this code under the terms of the GNU General Public License, but WITHOUT WARRANTY; without even the implied warranty of MERCHANTABILITY or FITNESS FOR A PARTICULAR PURPOSE.

See the GNU General Public License for more details.

Alternatively, you can license this code under a commercial license, as set out in <<http://cesanta.com>>.

22. wpa_supplicant and hostapd

Copyright (c) 2002-2012, Jouni Malinen <j@w1.fi> and contributors
All Rights Reserved.

These programs are licensed under the BSD license (the one with advertisement clause removed).

If you are submitting changes to the project, please see CONTRIBUTIONS file for more instructions.

This package may include either wpa_supplicant, hostapd, or both. See README file respective subdirectories (wpa_supplicant/README or hostapd/README) for more details.

Source code files were moved around in v0.6.x releases and compared to earlier releases, the programs are now built by first going to a subdirectory (wpa_supplicant or hostapd) and creating build configuration (.config) and running 'make' there (for Linux/BSD/cygwin builds).

License

This software may be distributed, used, and modified under the terms of BSD license:

Redistribution and use in source and binary forms, with or without modification, are permitted provided that the following conditions are met:

1. Redistributions of source code must retain the above copyright notice, this list of conditions and the following disclaimer.
2. Redistributions in binary form must reproduce the above copyright notice, this list of conditions and the following disclaimer in the documentation and/or other materials provided with the distribution.
3. Neither the name(s) of the above-listed copyright holder(s) nor the names of its contributors may be used to endorse or promote products derived from this software without specific prior written permission.

THIS SOFTWARE IS PROVIDED BY THE COPYRIGHT HOLDERS AND CONTRIBUTORS "AS IS" AND ANY EXPRESS OR IMPLIED WARRANTIES, INCLUDING, BUT NOT LIMITED TO, THE IMPLIED WARRANTIES OF MERCHANTABILITY AND FITNESS FOR A PARTICULAR PURPOSE ARE DISCLAIMED. IN NO EVENT SHALL THE COPYRIGHT OWNER OR CONTRIBUTORS BE LIABLE FOR ANY DIRECT, INDIRECT, INCIDENTAL, SPECIAL, EXEMPLARY, OR CONSEQUENTIAL DAMAGES (INCLUDING, BUT NOT LIMITED TO, PROCUREMENT OF SUBSTITUTE GOODS OR SERVICES; LOSS OF USE, DATA, OR PROFITS; OR BUSINESS INTERRUPTION) HOWEVER CAUSED AND ON ANY THEORY OF LIABILITY, WHETHER IN CONTRACT, STRICT LIABILITY, OR TORT (INCLUDING NEGLIGENCE OR OTHERWISE) ARISING IN ANY WAY OUT OF THE USE OF THIS SOFTWARE, EVEN IF ADVISED OF THE POSSIBILITY OF SUCH DAMAGE.

23. libxml2

Copyright (C) 1998-2003 Daniel Veillard. All Rights Reserved.

Permission is hereby granted, free of charge, to any person obtaining a copy of this software and associated documentation files (the "Software"), to deal in the Software without restriction, including without limitation the rights to use, copy, modify, merge, publish, distribute, sublicense, and/or sell copies of the Software, and to permit persons to whom the Software is furnished to do so, subject to the following conditions:

The above copyright notice and this permission notice shall be included in all copies or substantial portions of the Software.

THE SOFTWARE IS PROVIDED "AS IS", WITHOUT WARRANTY OF ANY KIND, EXPRESS OR IMPLIED, INCLUDING BUT NOT LIMITED TO THE WARRANTIES OF MERCHANTABILITY, FITNESS FOR A PARTICULAR PURPOSE AND NONINFRINGEMENT. IN NO EVENT SHALL THE DANIEL VEILLARD BE LIABLE FOR ANY CLAIM, DAMAGES OR OTHER LIABILITY, WHETHER IN AN ACTION OF CONTRACT, TORT OR OTHERWISE, ARISING FROM, OUT OF OR IN CONNECTION WITH THE SOFTWARE OR THE USE OR OTHER DEALINGS IN THE SOFTWARE.

Except as contained in this notice, the name of Daniel Veillard shall not be used in advertising or otherwise to promote the sale, use or other dealings in this Software without prior written authorization from him.

24.xerces-c

Apache License

Version 2.0, January 2004

<http://www.apache.org/licenses/>

TERMS AND CONDITIONS FOR USE, REPRODUCTION, AND DISTRIBUTION

1. Definitions.

"License" shall mean the terms and conditions for use, reproduction, and distribution as defined by Sections 1 through 9 of this document.

"Licensor" shall mean the copyright owner or entity authorized by the copyright owner that is granting the License.

"Legal Entity" shall mean the union of the acting entity and all other entities that control, are controlled by, or are under common control with that entity. For the purposes of this definition, "control" means (i) the power, direct or indirect, to cause the direction or management of such entity, whether by contract or otherwise, or (ii) ownership of fifty percent (50%) or more of the outstanding shares, or (iii) beneficial ownership of such entity.

"You" (or "Your") shall mean an individual or Legal Entity exercising permissions granted by this License.

"Source" form shall mean the preferred form for making modifications, including but not limited to software source code, documentation source, and configuration files.

"Object" form shall mean any form resulting from mechanical transformation or translation of a Source form, including but not limited to compiled object code, generated documentation, and conversions to other media types.

"Work" shall mean the work of authorship, whether in Source or Object form, made available under the License, as indicated by a copyright notice that is included in or attached to the work (an example is provided in the Appendix below).

"Derivative Works" shall mean any work, whether in Source or Object form, that is based on (or derived from) the Work and for which the editorial revisions, annotations, elaborations, or other modifications

represent, as a whole, an original work of authorship. For the purposes of this License, Derivative Works shall not include works that remain separable from, or merely link (or bind by name) to the interfaces of, the Work and Derivative Works thereof.

"Contribution" shall mean any work of authorship, including the original version of the Work and any modifications or additions to that Work or Derivative Works thereof, that is intentionally submitted to Licensor for inclusion in the Work by the copyright owner or by an individual or Legal Entity authorized to submit on behalf of the copyright owner. For the purposes of this definition, "submitted" means any form of electronic, verbal, or written communication sent to the Licensor or its representatives, including but not limited to communication on electronic mailing lists, source code control systems, and issue tracking systems that are managed by, or on behalf of, the Licensor for the purpose of discussing and improving the Work, but excluding communication that is conspicuously marked or otherwise designated in writing by the copyright owner as "Not a Contribution."

"Contributor" shall mean Licensor and any individual or Legal Entity on behalf of whom a Contribution has been received by Licensor and subsequently incorporated within the Work.

2. Grant of Copyright License. Subject to the terms and conditions of this License, each Contributor hereby grants to You a perpetual,

worldwide, non-exclusive, no-charge, royalty-free, irrevocable copyright license to reproduce, prepare Derivative Works of, publicly display, publicly perform, sublicense, and distribute the Work and such Derivative Works in Source or Object form.

3. Grant of Patent License. Subject to the terms and conditions of this License, each Contributor hereby grants to You a perpetual, worldwide, non-exclusive, no-charge, royalty-free, irrevocable (except as stated in this section) patent license to make, have made, use, offer to sell, sell, import, and otherwise transfer the Work, where such license applies only to those patent claims licensable by such Contributor that are necessarily infringed by their Contribution(s) alone or by combination of their Contribution(s) with the Work to which such Contribution(s) was submitted. If You institute patent litigation against any entity (including a cross-claim or counterclaim in a lawsuit) alleging that the Work or a Contribution incorporated within the Work constitutes direct or contributory patent infringement, then any patent licenses granted to You under this License for that Work shall terminate as of the date such litigation is filed.
4. Redistribution. You may reproduce and distribute copies of the Work or Derivative Works thereof in any medium, with or without modifications, and in Source or Object form, provided that You meet the following conditions:
 - (a) You must give any other recipients of the Work or Derivative Works a copy of this License; and
 - (b) You must cause any modified files to carry prominent notices stating that You changed the files; and
 - (c) You must retain, in the Source form of any Derivative Works that You distribute, all copyright, patent, trademark, and attribution notices from the Source form of the Work, excluding those notices that do not pertain to any part of the Derivative Works; and
 - (d) If the Work includes a "NOTICE" text file as part of its distribution, then any Derivative Works that You distribute must include a readable copy of the attribution notices contained within such NOTICE file, excluding those notices that do not pertain to any part of the Derivative Works, in at least one of the following places: within a NOTICE text file distributed as part of the Derivative Works; within the Source form or documentation, if provided along with the Derivative Works; or, within a display generated by the Derivative Works, if and wherever such third-party notices normally appear. The contents of the NOTICE file are for informational purposes only and do not modify the License. You may add Your own attribution notices within Derivative Works that You distribute, alongside or as an addendum to the NOTICE text from the Work, provided that such additional attribution notices cannot be construed as modifying the License.

You may add Your own copyright statement to Your modifications and may provide additional or different license terms and conditions for use, reproduction, or distribution of Your modifications, or for any such Derivative Works as a whole, provided Your use, reproduction, and distribution of the Work otherwise complies with the conditions stated in this License.

5. Submission of Contributions. Unless You explicitly state otherwise, any Contribution intentionally submitted for inclusion in the Work by You to the Licensor shall be under the terms and conditions of this License, without any additional terms or conditions. Notwithstanding the above, nothing herein shall supersede or modify the terms of any separate license agreement you may have executed with Licensor regarding such Contributions.
6. Trademarks. This License does not grant permission to use the trade names, trademarks, service marks, or product names of the Licensor, except as required for reasonable and customary use in

describing the origin of the Work and reproducing the content of the NOTICE file.

7. Disclaimer of Warranty. Unless required by applicable law or agreed to in writing, Licensor provides the Work (and each Contributor provides its Contributions) on an "AS IS" BASIS, WITHOUT WARRANTIES OR CONDITIONS OF ANY KIND, either express or implied, including, without limitation, any warranties or conditions of TITLE, NON-INFRINGEMENT, MERCHANTABILITY, or FITNESS FOR A PARTICULAR PURPOSE. You are solely responsible for determining the appropriateness of using or redistributing the Work and assume any risks associated with Your exercise of permissions under this License.
8. Limitation of Liability. In no event and under no legal theory, whether in tort (including negligence), contract, or otherwise, unless required by applicable law (such as deliberate and grossly negligent acts) or agreed to in writing, shall any Contributor be liable to You for damages, including any direct, indirect, special, incidental, or consequential damages of any character arising as a result of this License or out of the use or inability to use the Work (including but not limited to damages for loss of goodwill, work stoppage, computer failure or malfunction, or any and all other commercial damages or losses), even if such Contributor has been advised of the possibility of such damages.
9. Accepting Warranty or Additional Liability. While redistributing the Work or Derivative Works thereof, You may choose to offer, and charge a fee for, acceptance of support, warranty, indemnity, or other liability obligations and/or rights consistent with this License. However, in accepting such obligations, You may act only on Your own behalf and on Your sole responsibility, not on behalf of any other Contributor, and only if You agree to indemnify, defend, and hold each Contributor harmless for any liability incurred by, or claims asserted against, such Contributor by reason of your accepting any such warranty or additional liability.

END OF TERMS AND CONDITIONS

APPENDIX: How to apply the Apache License to your work.

To apply the Apache License to your work, attach the following boilerplate notice, with the fields enclosed by brackets "[]" replaced with your own identifying information. (Don't include the brackets!) The text should be enclosed in the appropriate comment syntax for the file format. We also recommend that a file or class name and description of purpose be included on the same "printed page" as the copyright notice for easier identification within third-party archives.

Copyright [yyyy] [name of copyright owner]

Licensed under the Apache License, Version 2.0 (the "License"); you may not use this file except in compliance with the License. You may obtain a copy of the License at <http://www.apache.org/licenses/LICENSE-2.0>

Unless required by applicable law or agreed to in writing, software distributed under the License is distributed on an "AS IS" BASIS, WITHOUT WARRANTIES OR CONDITIONS OF ANY KIND, either express or implied. See the License for the specific language governing permissions and limitations under the License.

OSS text_MT8507_V2.0_2k15



Specifications are subject to change without notice

Copyright © 2015 Gibson Innovations Limited. Revised Edition © 2017

This product has been manufactured by, and is sold under the responsibility of Gibson Innovations Ltd., and Gibson Innovations Ltd. is the warrantor in relation to this product. Philips and the Philips Shield Emblem are registered trademarks of Koninklijke Philips N.V. and are used under license.

HTL5160B_12_UM_V7.0

