

HP8618

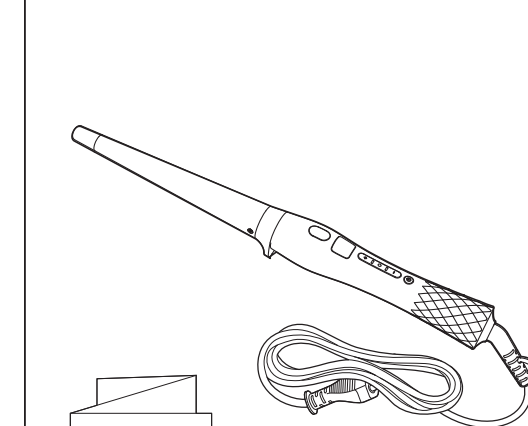

- | | |
|---------------------|----------------------|
| 1. Uur Manoel | 11. Pluza Estreita |
| 2. Engrenagem | 12. Pluza estreita |
| 3. Botão de Ligação | 13. Botão de Ligação |
| 4. Engrenagem | 14. Botão de Ligação |
| 5. Pluza larga | 15. Botão de Ligação |
| 6. Pluza de reserva | 16. Botão de Ligação |
| 7. Pluza estreita | 17. Botão de Ligação |

PHILIPS

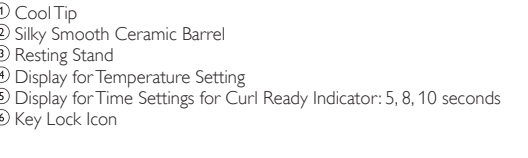
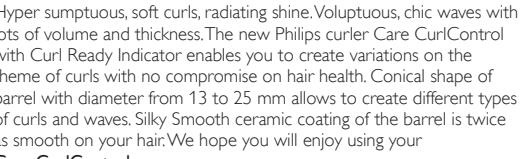
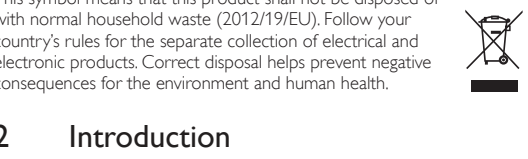
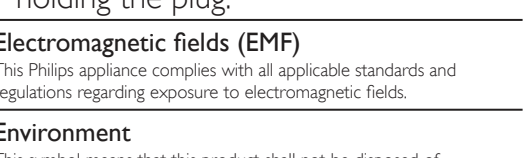
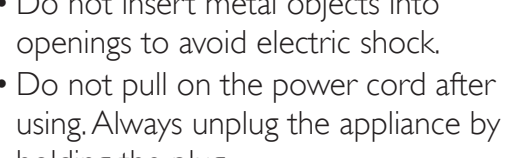
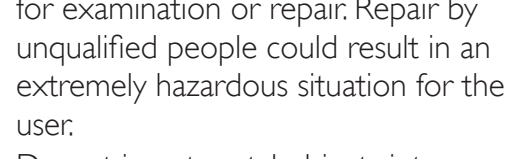
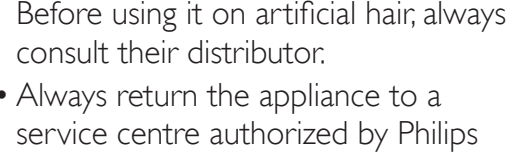
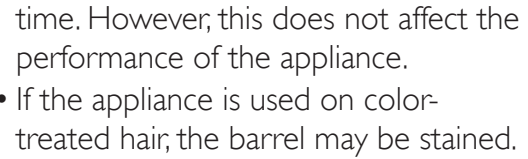
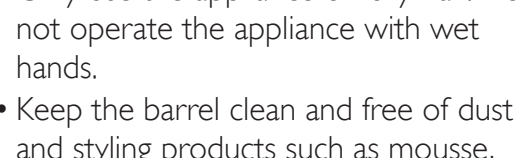
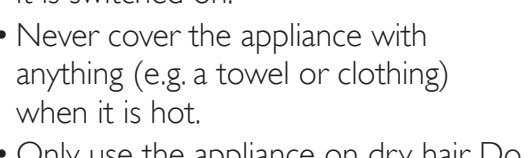
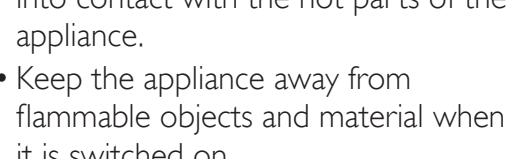
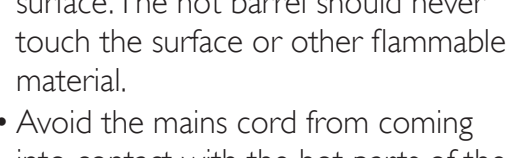
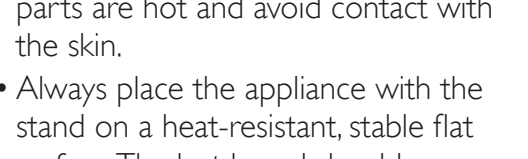
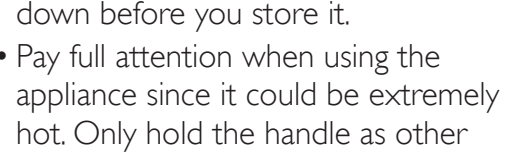
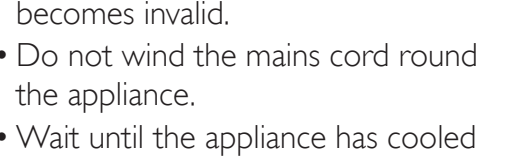
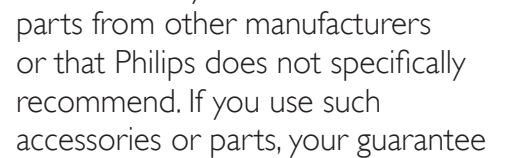
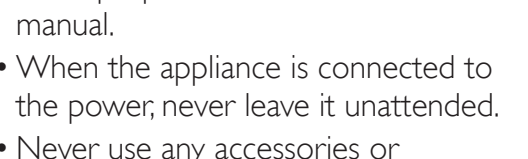
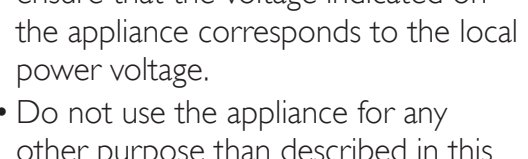
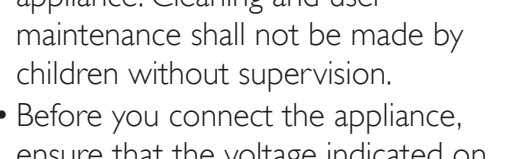
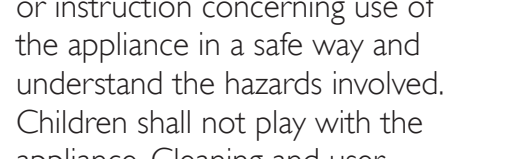
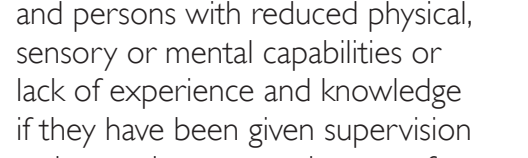
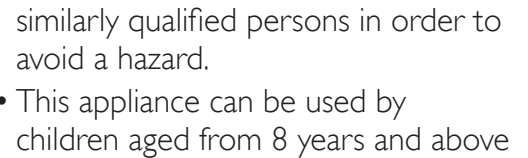
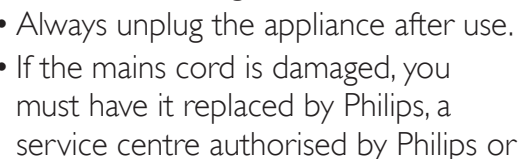
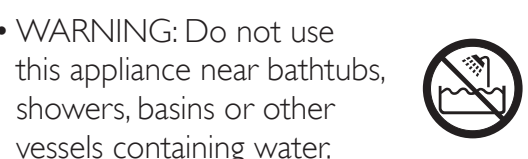
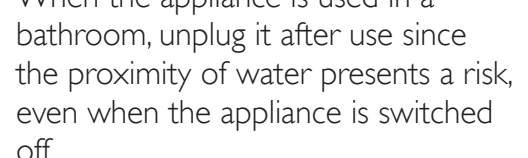
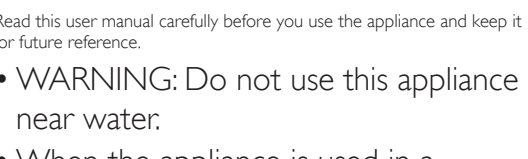
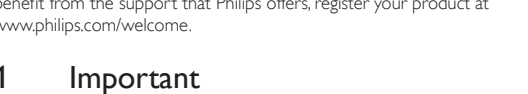
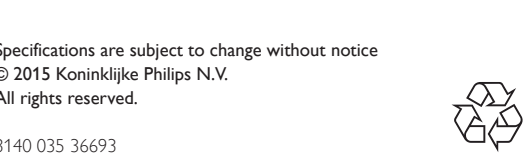

- | | |
|---------------------|----------------------|
| 1. Uur Manoel | 11. Pluza Estreita |
| 2. Engrenagem | 12. Pluza estreita |
| 3. Botão de Ligação | 13. Botão de Ligação |
| 4. Engrenagem | 14. Botão de Ligação |
| 5. Pluza larga | 15. Botão de Ligação |
| 6. Pluza de reserva | 16. Botão de Ligação |
| 7. Pluza estreita | 17. Botão de Ligação |

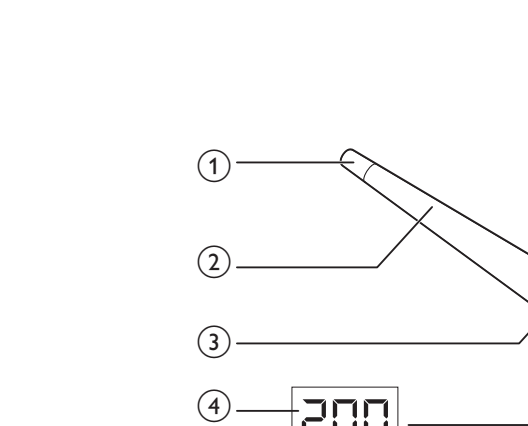
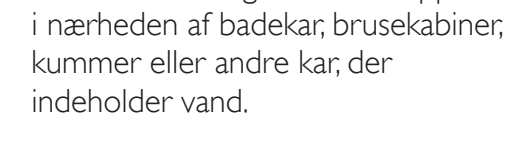
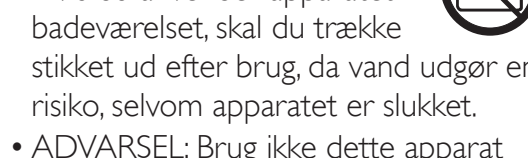
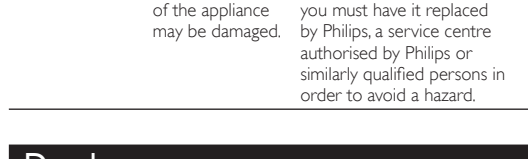
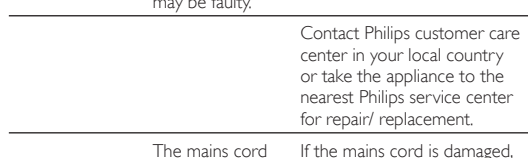
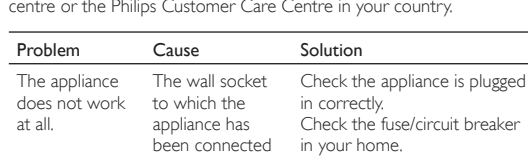
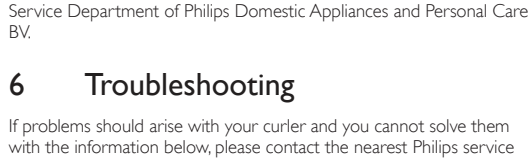
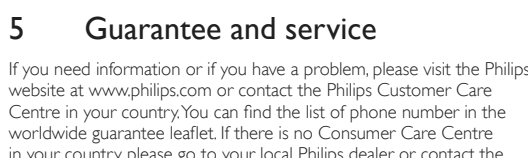
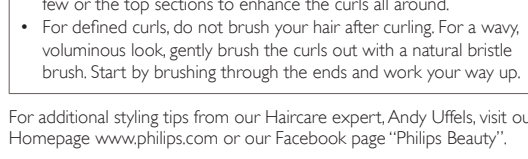
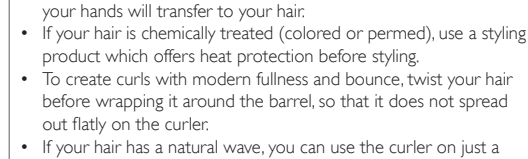
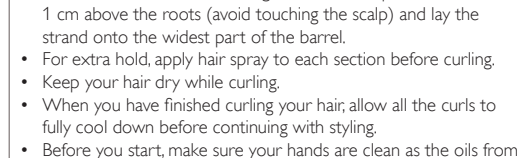
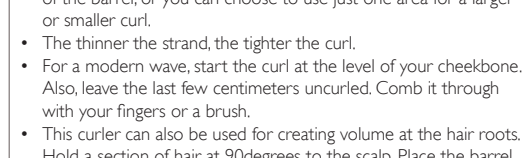
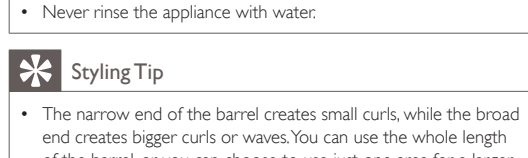
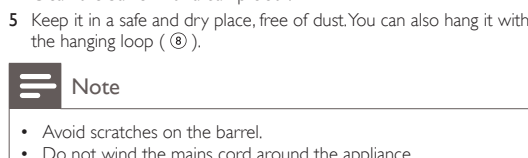
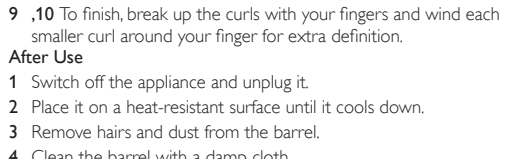
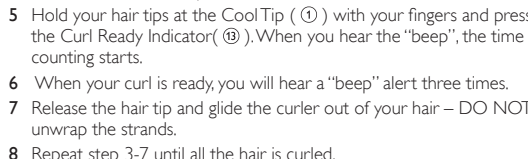
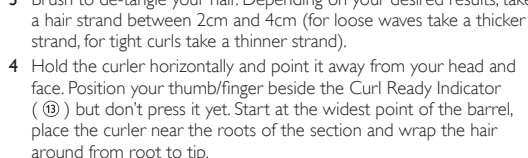
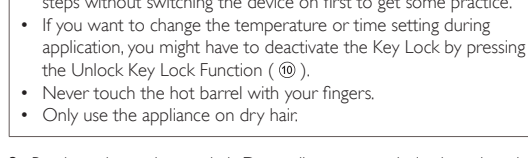
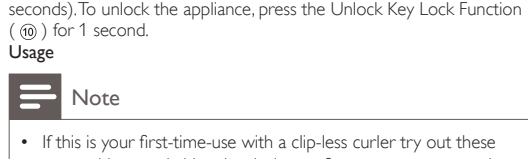
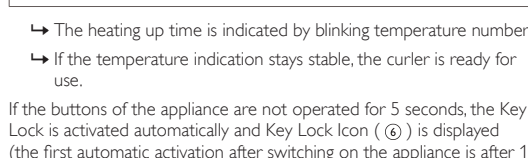
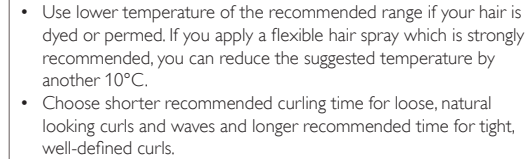
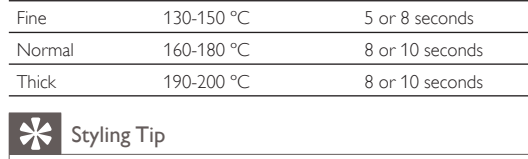
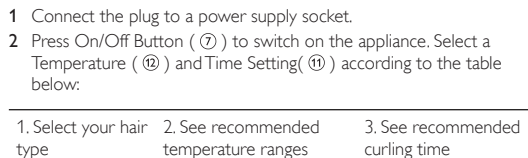
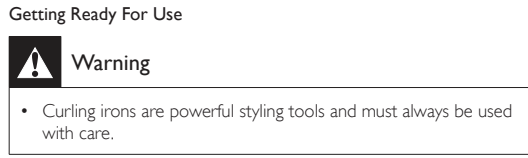
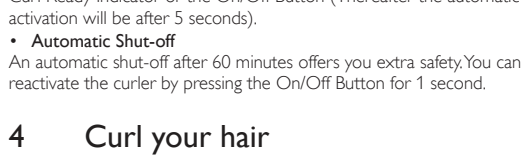
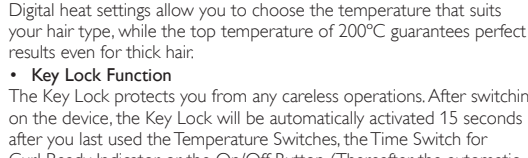
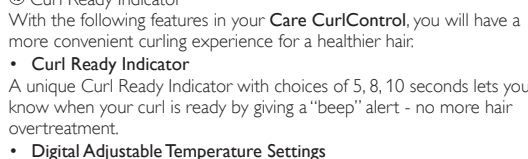
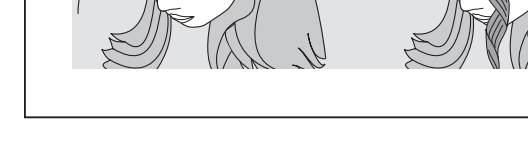
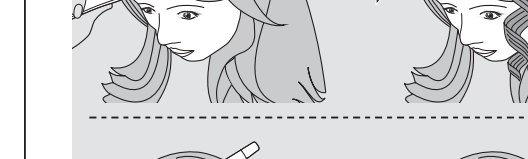
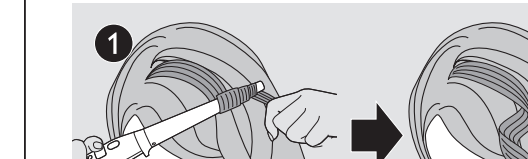
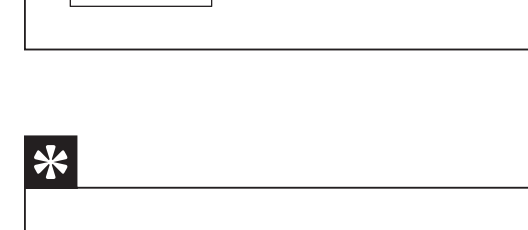

- | | |
|---------------------|----------------------|
| 1. Uur Manoel | 11. Pluza Estreita |
| 2. Engrenagem | 12. Pluza estreita |
| 3. Botão de Ligação | 13. Botão de Ligação |
| 4. Engrenagem | 14. Botão de Ligação |
| 5. Pluza larga | 15. Botão de Ligação |
| 6. Pluza de reserva | 16. Botão de Ligação |
| 7. Pluza estreita | 17. Botão de Ligação |

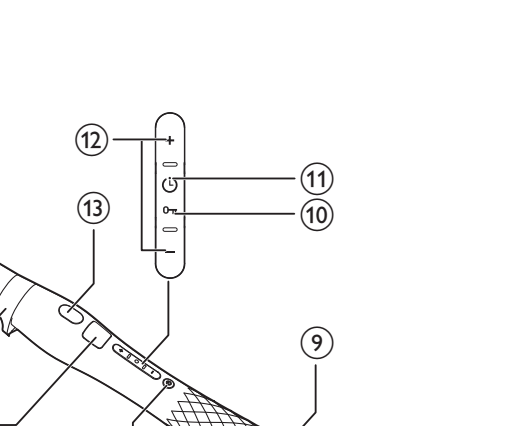
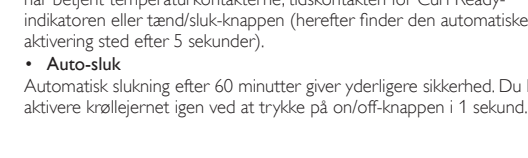
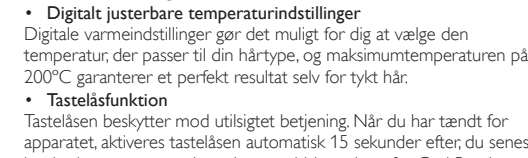
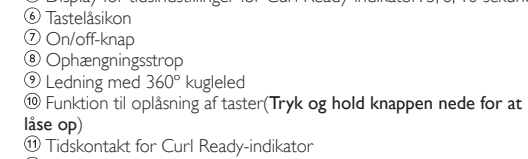
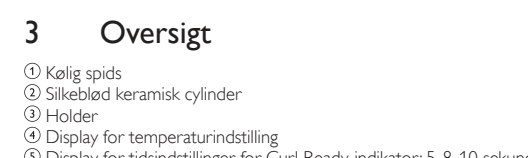
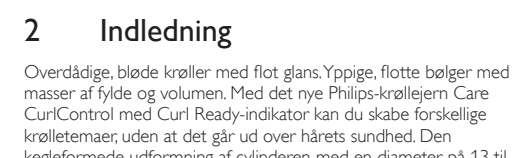
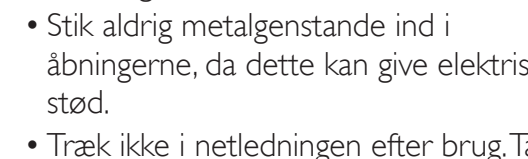
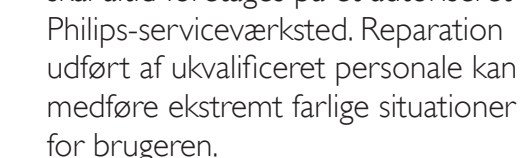
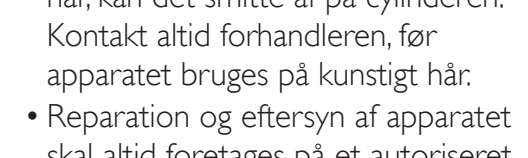
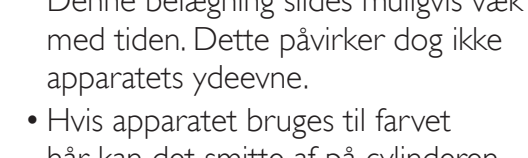
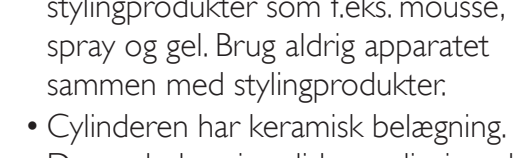
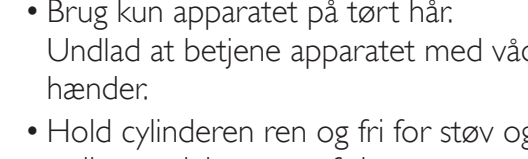
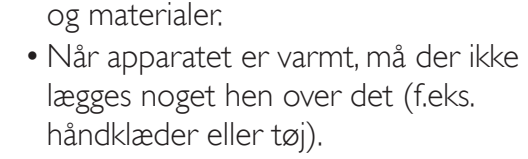
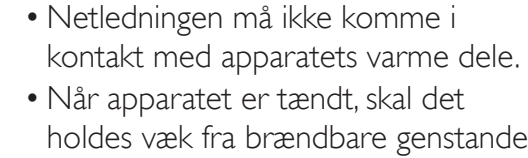
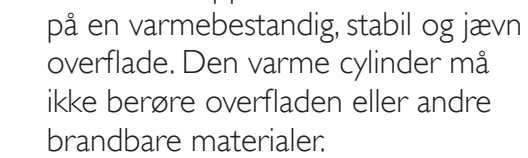
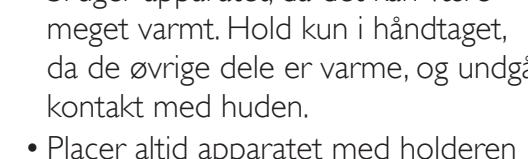
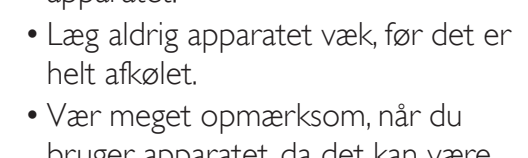
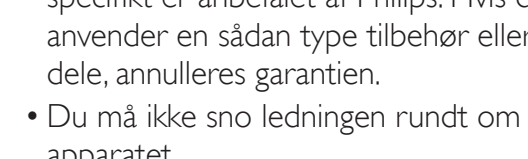
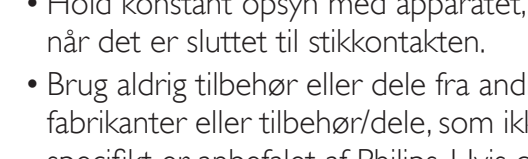
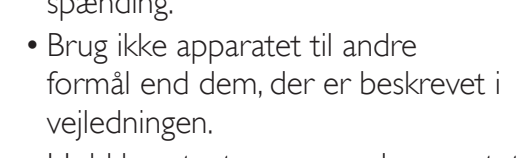
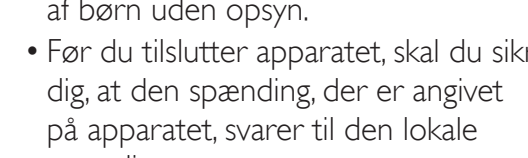
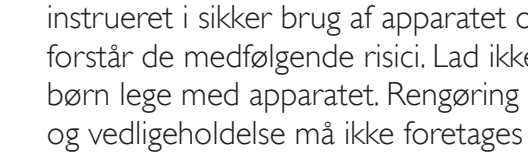
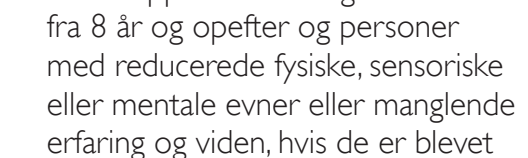
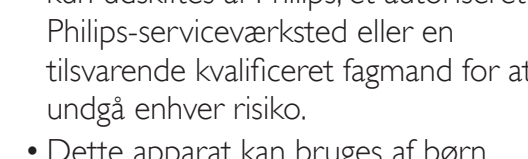
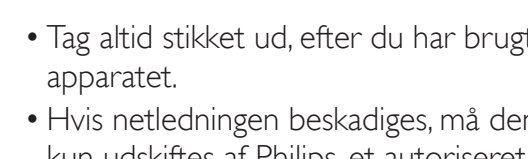
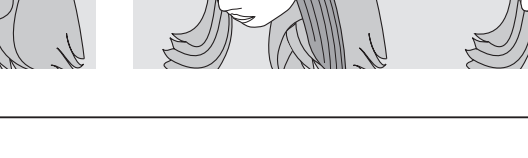
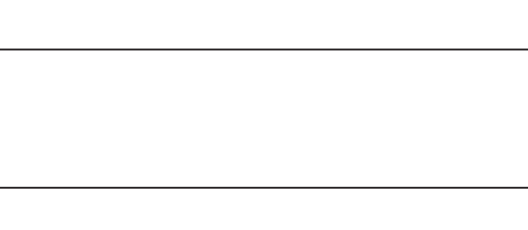

- | | |
|---------------------|----------------------|
| 1. Uur Manoel | 11. Pluza Estreita |
| 2. Engrenagem | 12. Pluza estreita |
| 3. Botão de Ligação | 13. Botão de Ligação |
| 4. Engrenagem | 14. Botão de Ligação |
| 5. Pluza larga | 15. Botão de Ligação |
| 6. Pluza de reserva | 16. Botão de Ligação |
| 7. Pluza estreita | 17. Botão de Ligação |

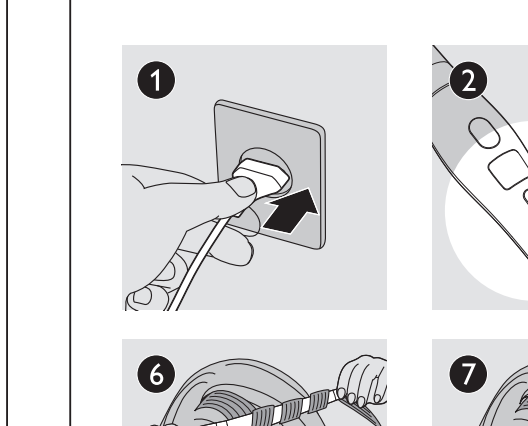
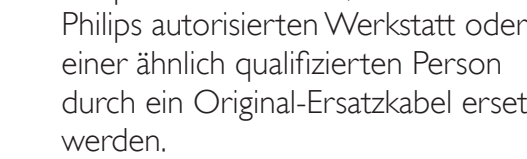
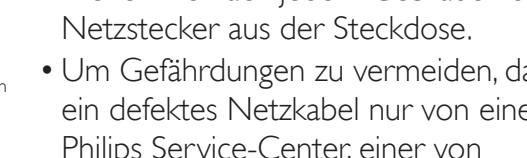
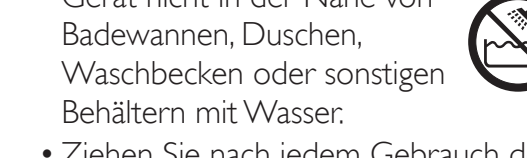
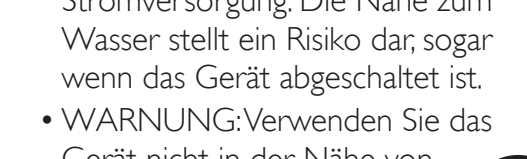
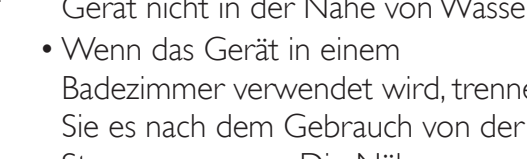
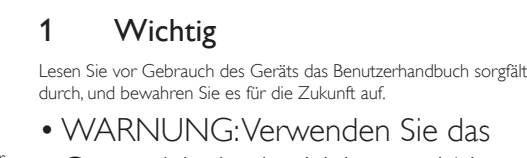
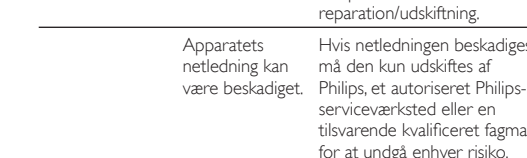
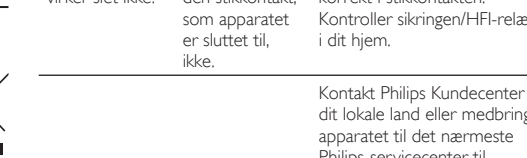
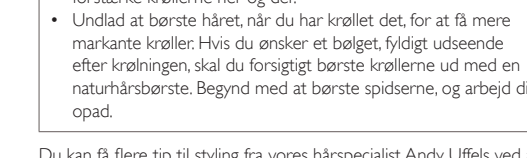
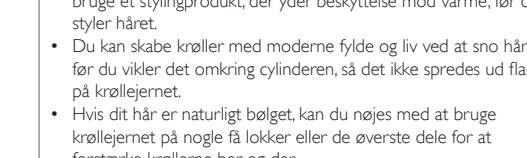
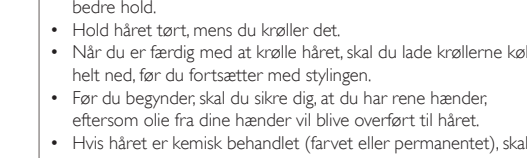
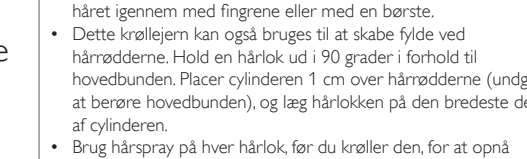
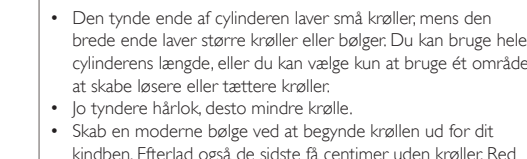
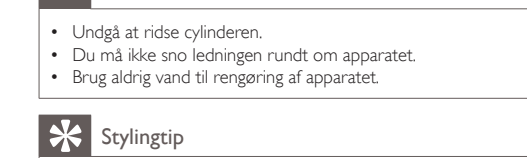
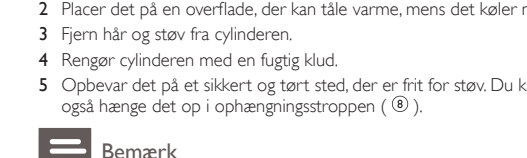
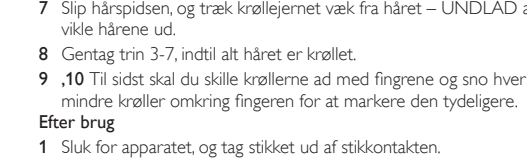
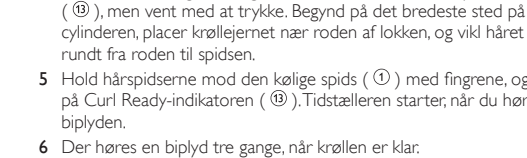
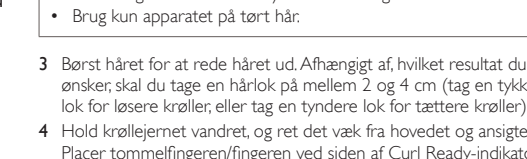
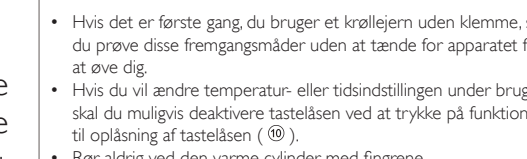
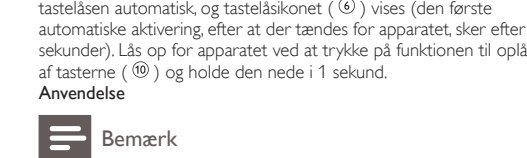
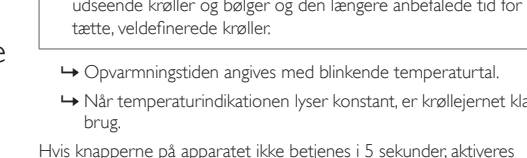
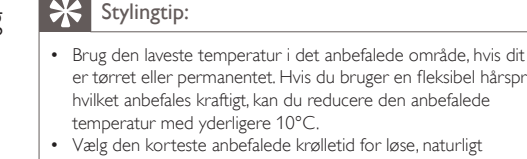
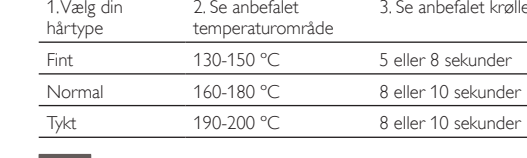
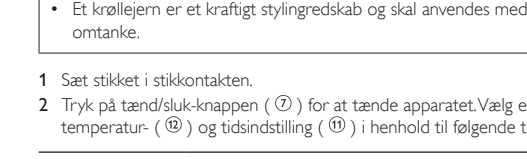
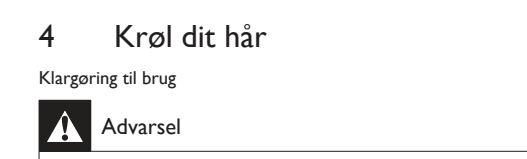
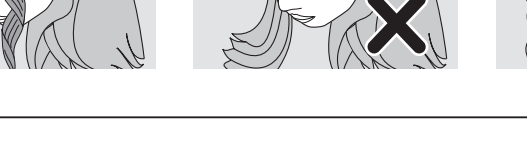
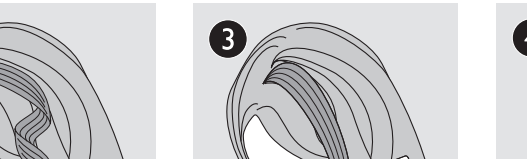
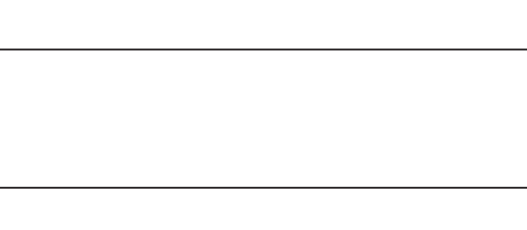

- | | |
|---------------------|----------------------|
| 1. Uur Manoel | 11. Pluza Estreita |
| 2. Engrenagem | 12. Pluza estreita |
| 3. Botão de Ligação | 13. Botão de Ligação |
| 4. Engrenagem | 14. Botão de Ligação |
| 5. Pluza larga | 15. Botão de Ligação |
| 6. Pluza de reserva | 16. Botão de Ligação |
| 7. Pluza estreita | 17. Botão de Ligação |

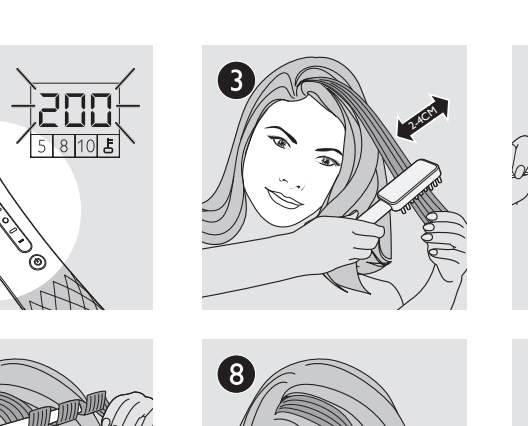
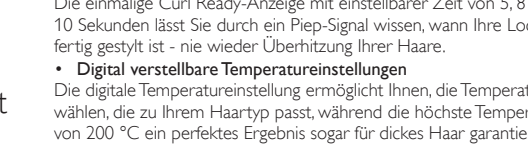
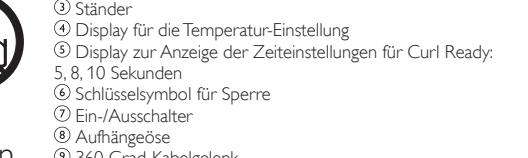
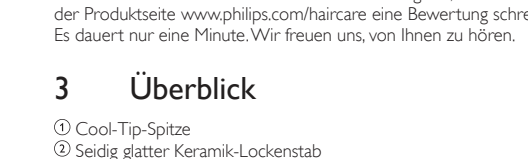
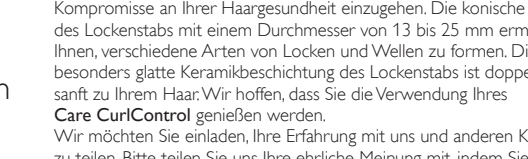
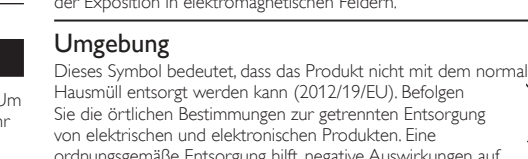
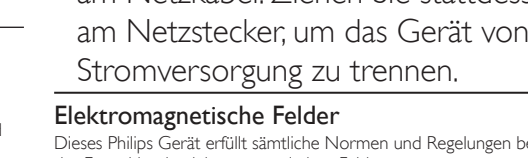
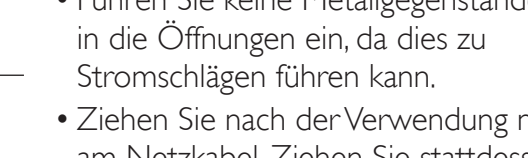
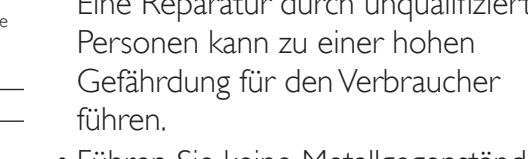
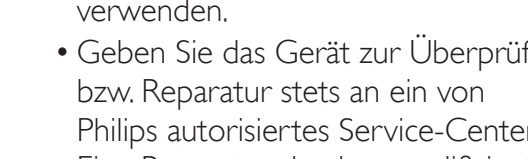
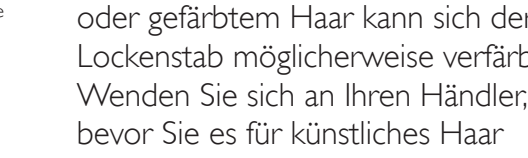
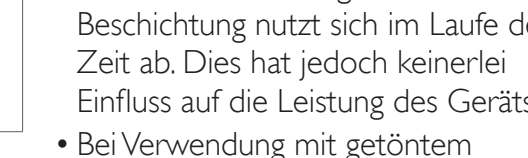
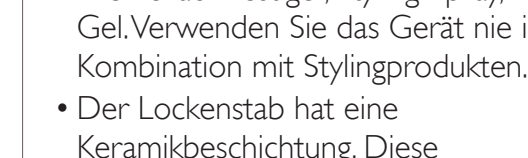
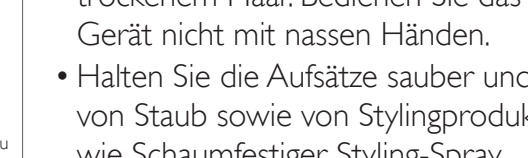
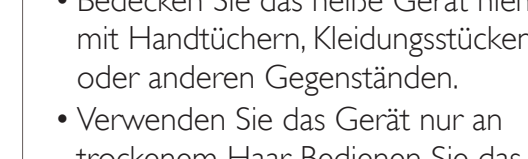
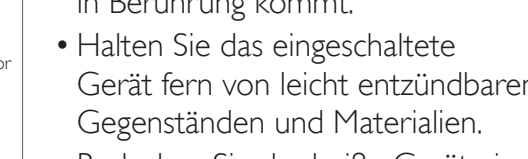
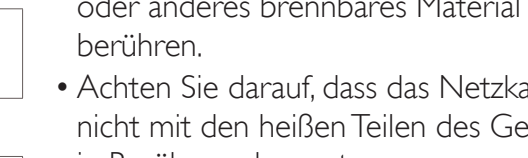
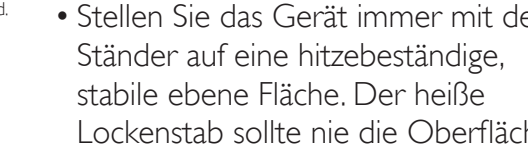
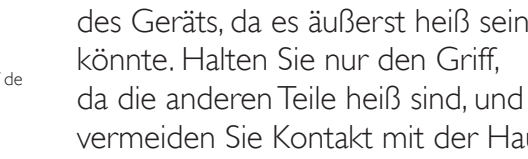
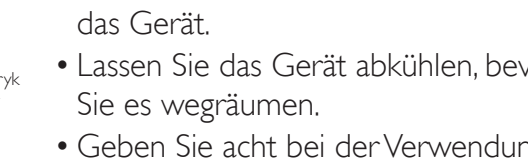
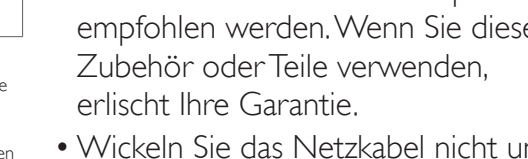
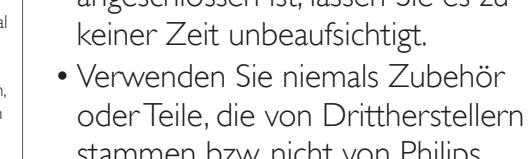
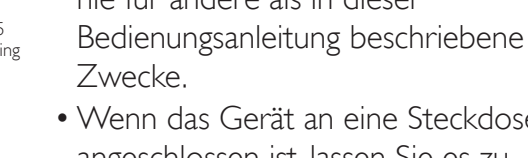
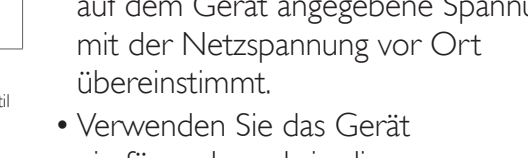
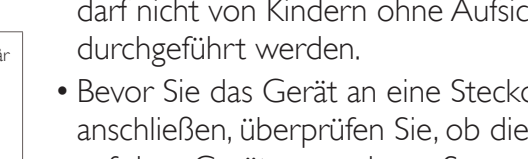
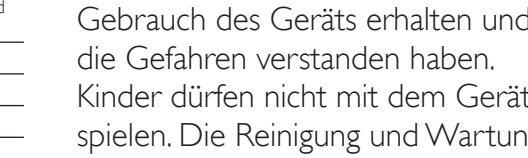
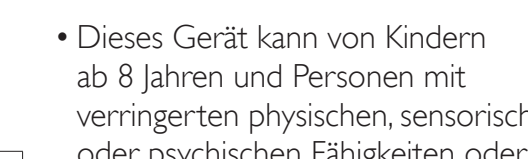
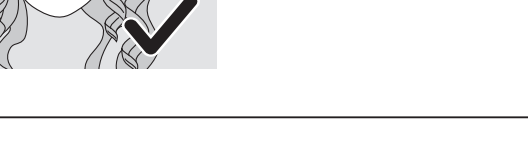
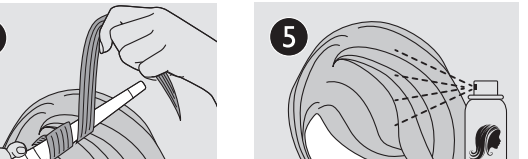
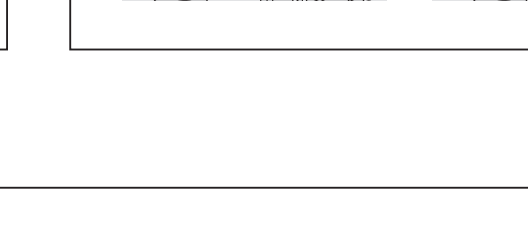

- | | |
|---------------------|----------------------|
| 1. Uur Manoel | 11. Pluza Estreita |
| 2. Engrenagem | 12. Pluza estreita |
| 3. Botão de Ligação | 13. Botão de Ligação |
| 4. Engrenagem | 14. Botão de Ligação |
| 5. Pluza larga | 15. Botão de Ligação |
| 6. Pluza de reserva | 16. Botão de Ligação |
| 7. Pluza estreita | 17. Botão de Ligação |

