

# PHILIPS

## Quick Start Card

HF3506, HF3505

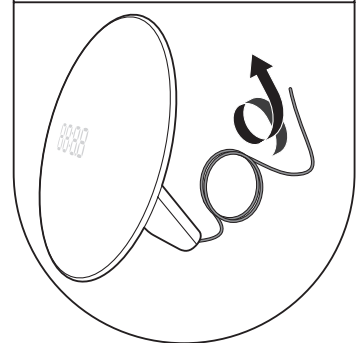
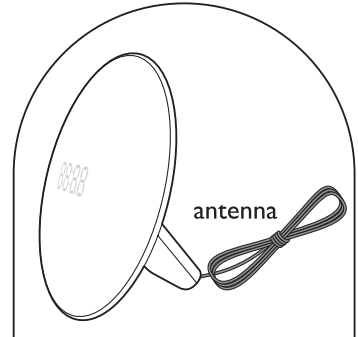
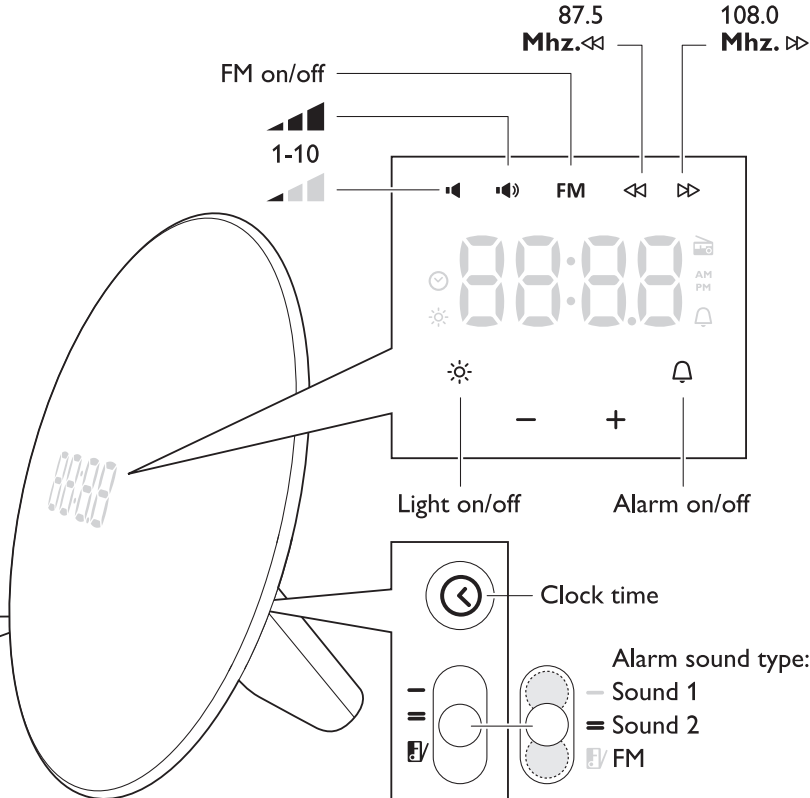
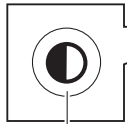
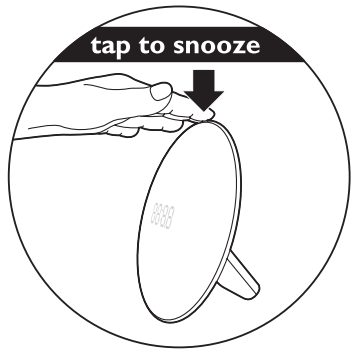

English	Dansk	Deutsch	Español	Suomi
Tap to snooze	Tryk for at snooze	Tippen für Schlummerfunktion	Golpee levemente para retrasar la alarma	Torkkutila napauttamalla
Light on/off	Lys til/fra	Licht ein-/ausschalten	Encendido/apagado de la luz	Merkkivalo päällä/pois
Alarm on/off	Alarm til/fra	Wecker ein-/ausschalten	Encendido/apagado de la alarma	Hälytys on/ei
Antenna	Antenne	Antenne	Antena	Antenni
Display brightness	Skærmysstyrke	Anzeigeelligkeit	Brillo de la pantalla	Näytön kirkkaus
Clock time	Klokkeslæt	Uhrzeit	Hora del reloj	Kellonaika
Alarm sound type	Alarmlydtype	Weckton	Tipo de sonido de la alarma	Herätysäänen tyyppi

Français	Italiano	Nederlands	Norsk	Português
Taper pour répéter	Battere leggermente per attivare lo snooze	Tik om de sluimerfunctie te activeren	Trykk for å aktivere snooze	Toque levemente para função snooze
Lumière marche/arrêt	Luce accesa/spenta	Licht aan/uit	Lys av/på	Ligar/desligar a luz
Alarme marche/arrêt	Sveglia attiva/non attiva	Alarm aan/uit	Alarm av/på	Ligar/desligar o alarme
Antenne	Antenna	Antenne	Antenne	Antena
Luminosité de l'affichage	Luminosità display	Displayhelderheid	Visningslysstyrke	Brilho do visor
Heure (horloge)	Ora	Kloktijd	Klokkeslett	Hora do relógio
Type de sonnerie d'alarme	Tipo di suono della sveglia	Type wekgeluid	Alarmlydtype	Tipo de som do alarme

Svenska	Русский	快速入門指南	快速入门指南	Жұмысты бастаудың қысқаша нұсқаулығы
Slå lätt för att använda snooze-funktionen	нажмите, чтобы отсрочить сигнал будильника	拍一下可啟用貪睡功能	轻击以再响	Кейінге қалдыру үшін түртіңіз
Ljus på/av	Включить/выключить светильник	燈光開關	开/关灯	Жарықты қосу/өшіру
Larm på/av	Включить/выключить сигнал	鬧鐘開關	闹钟开/关	Оятқышты қосу/өшіру
Antenn	Антенна	天線	天线	Антенна
Teckenfönstrets ljusstyrka	Яркость дисплея	顯示亮度	显示亮度	Экран жарықтығы
Klocktid	Время на часах	時鐘時間	时钟时间	Сағат уақыты
Larmljudstyp	Тип сигнала будильника	鬧鐘音效類型	闹钟声音类型	Оятқыш дыбысының түрі

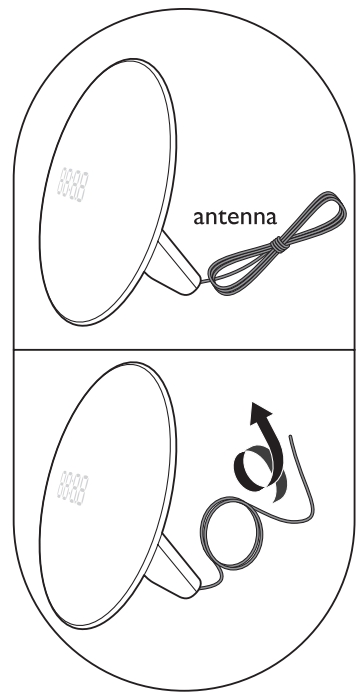
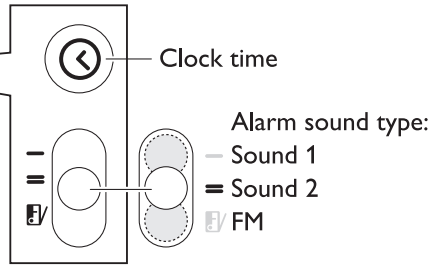
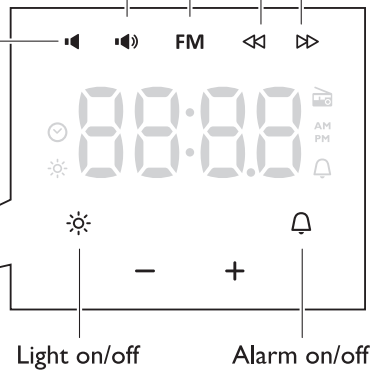
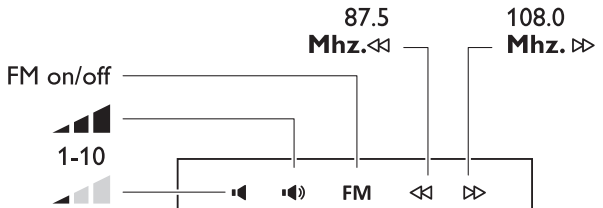
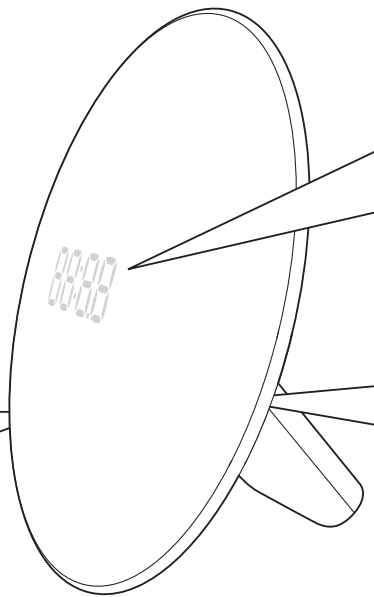
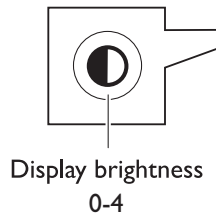
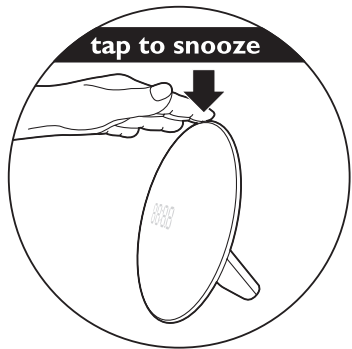

**Clock time** 

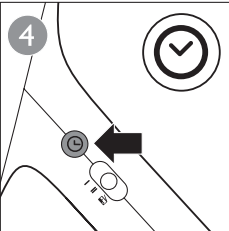
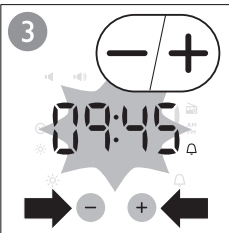
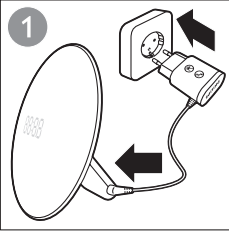

**12h/24h** **AM**  
**PM**

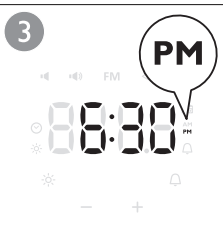
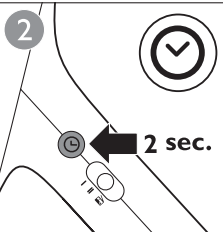
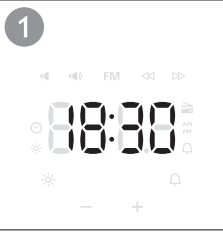

**Alarm time** 

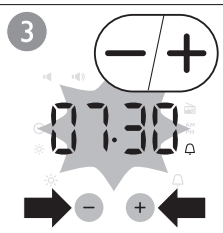

**Alarm on/off** 

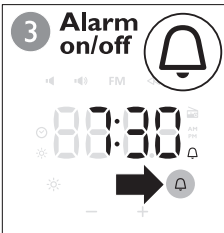
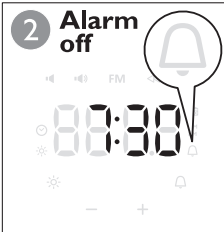

**Alarm sounds** 

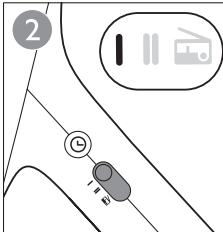
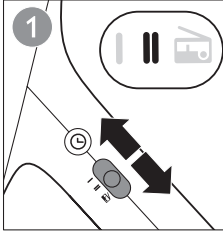

**Light 1-10** 

