

PHILIPS

Quick Start Card

HF3505

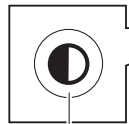
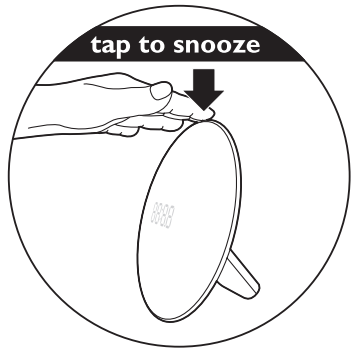

Display brightness
0-4

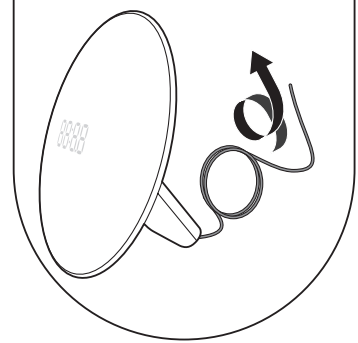
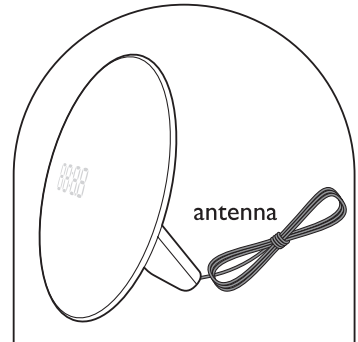
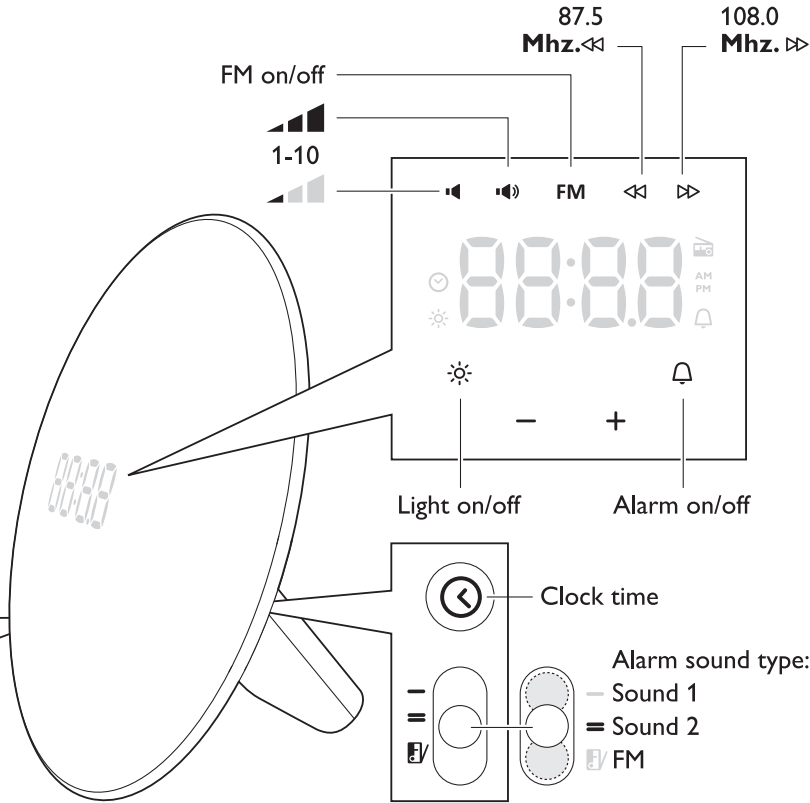

English	Eesti	Қазақша	Lietuviškai
Tap to snooze	Äratuse edasilükkamiseks vajutage nuppu	Кейинге қалдыру үшін түртіңіз	Bakstelėkite ir atidėkite
Light on/off	Lambi sisse-/väljalülitamine	Жарықты қосу/өшіру	Šviesos įjungimas / išjungimas
Alarm on/off	Äratuse sisse-/väljalülitamine	Оятқышты қосу/өшіру	Žadintuvo įjungimas / išjungimas
Antenna	Antenn	Антенна	Antena
Display brightness	Ekraani heledus	Экран жарықтығы	Ekranu ryškumas
Clock time	Kellaaeg	Сағат уақыты	Laikrodžio laikas
Alarm sound type	Äratusheli tüüp	Оятқыш дыбысының түрі	Žadintuvo garso tipas

Latviešu	Polski	Русский	Українська
Pieskarieties, lai aktivizētu snaudu	Dotknij, aby włączyć funkcję drzemki	Слегка ударьте, чтобы отложить сигнал	Торкніться для переходу в режим дрімоти
Gaismas ieslēgšana/izslēgšana	Włączanie/wyłączenie światła	Включить/выключить светильник	Увімкнення/вимкнення світла
Modinātāja ieslēgšana/izslēgšana	Włączanie/wyłączenie budzika	Включить/выключить сигнал	Увімкнення/вимкнення будильника
Antena	Antena	Антенна	Антенa
Displeja spilgtums	Jasność wyświetlacza	Яркость дисплея	Яскравість дисплея
Pulksteņa laiks	Czas zegara	Время на часах	Годинник
Modinātāja skaņas tips	Rodzaj dźwięku budzika	Тип сигнала будильника	Тип звукового сигналу будильника

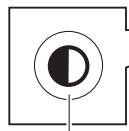
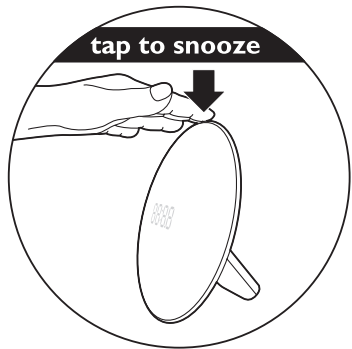

Display brightness
0-4

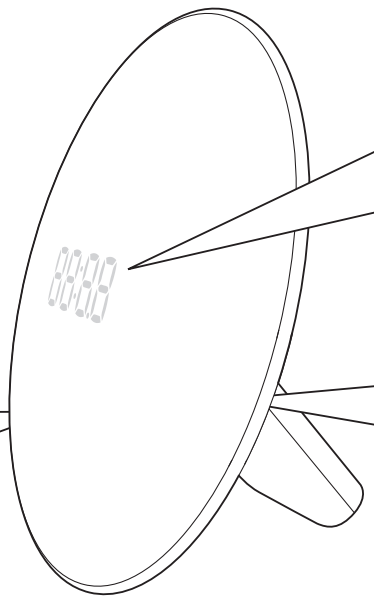

FM on/off



87.5
Mhz.<<

108.0
Mhz.>>

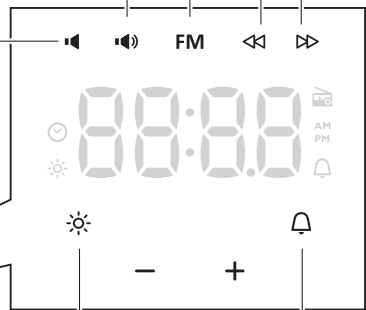

Light on/off

Alarm on/off

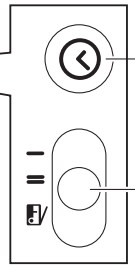

Clock time

Alarm sound type:

— Sound 1

= Sound 2

FM

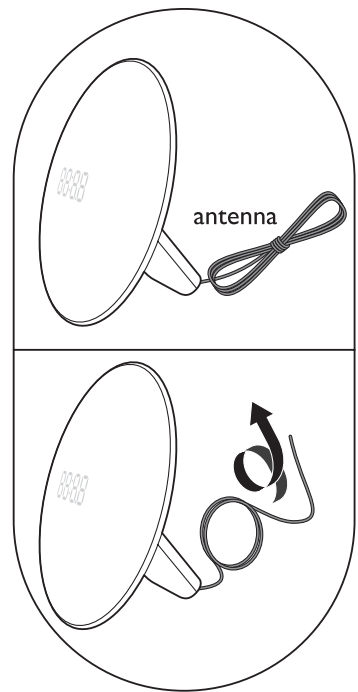

antenna

Clock time 

12h/24h AM PM

Alarm time 

Alarm on/off 

Alarm sounds 

Light 1-10 

