

Register your product and get support at  
[www.philips.com/welcome](http://www.philips.com/welcome)

HF3470

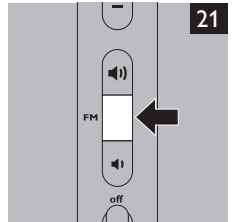

**PHILIPS**

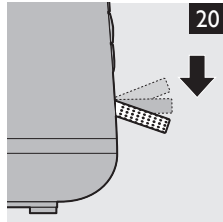
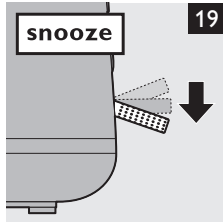
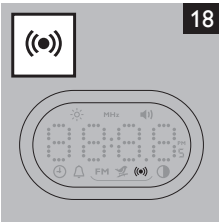
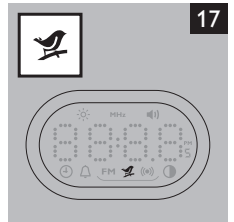
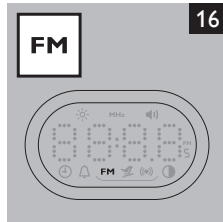
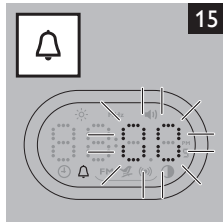
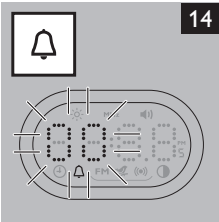
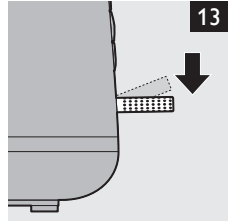
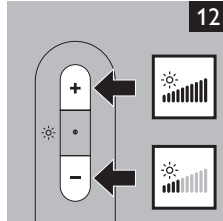
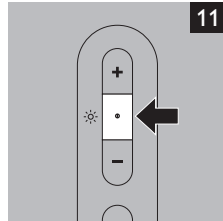
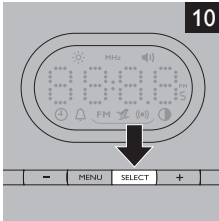
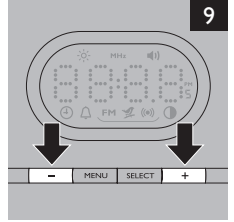
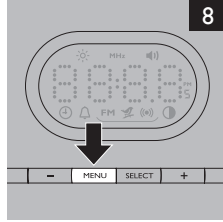
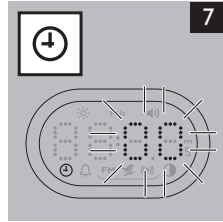
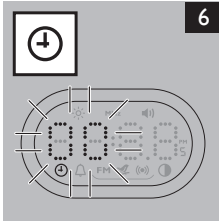
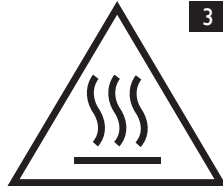
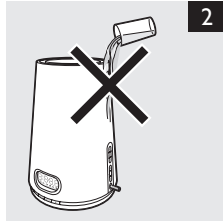
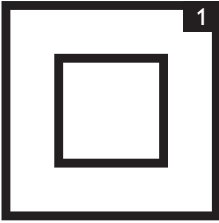

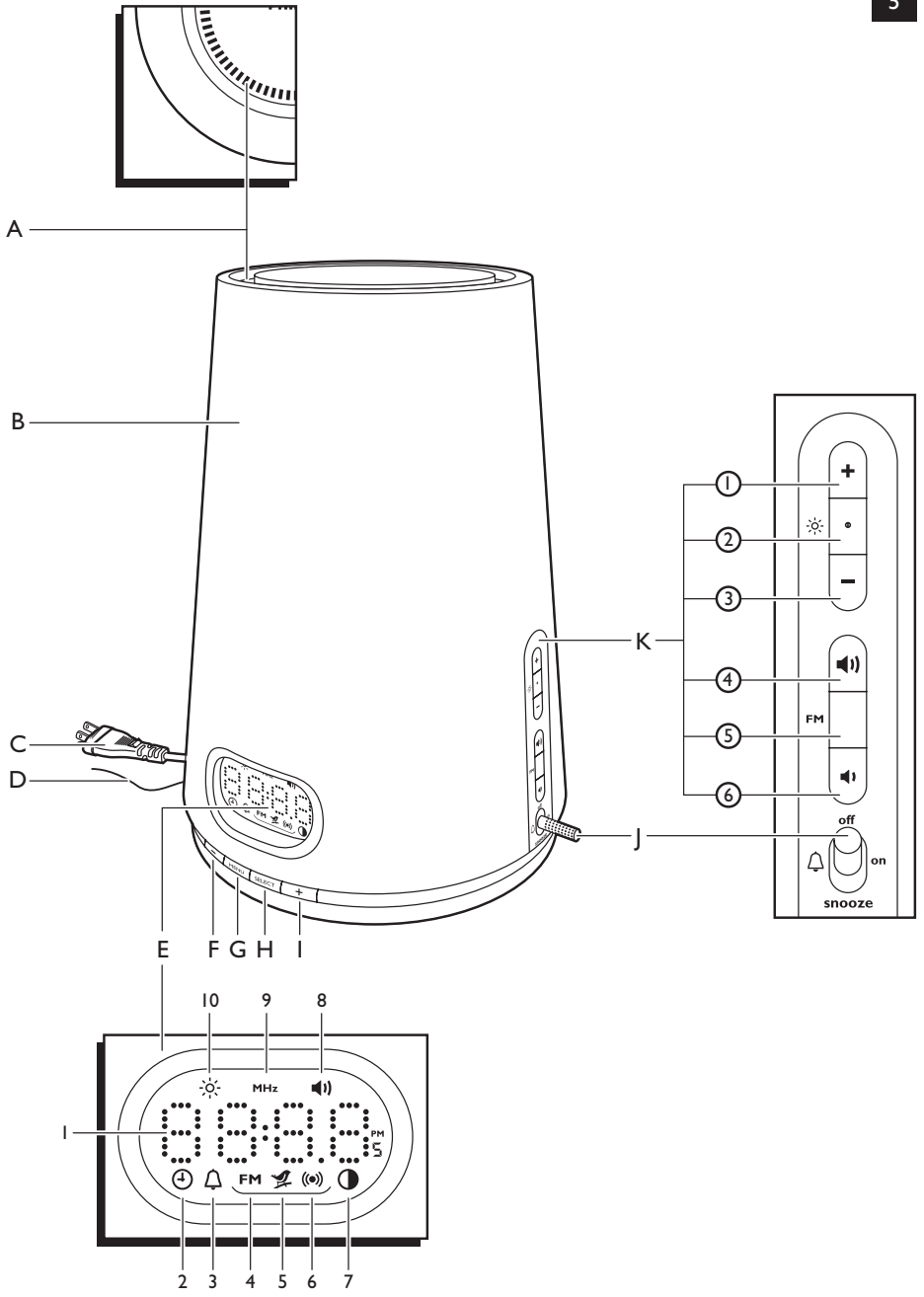

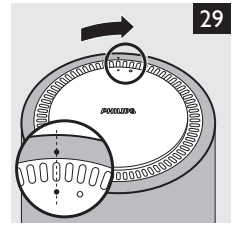
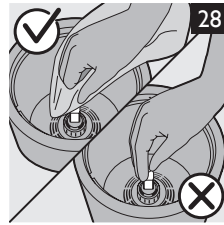
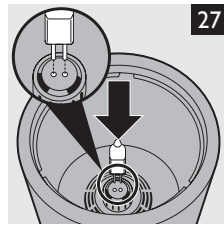
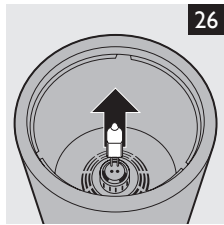
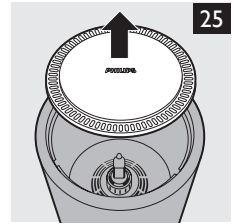
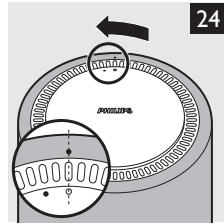
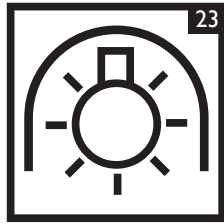
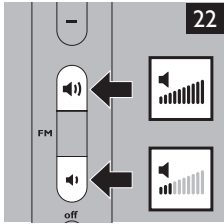

**HF3470**

**ENGLISH 8**

## IMPORTANT SAFETY INSTRUCTIONS

- This portable light has a polarized plug (one blade is wider than the other) as a feature to reduce the risk of electric shock. This plug will fit in a polarized outlet only one way. If the plug does not fit fully in the outlet, reverse the plug. If it still does not fit, contact a qualified electrician. Never use with an extension cord unless the plug can be fully inserted. Do not alter the plug.

## INSTRUCTIONS PERTAINING TO A RISK OF FIRE, ELECTRIC SHOCK, OR INJURY TO PERSONS

### Lighted lamp is HOT:

#### **WARNING – To reduce the risk of FIRE, ELECTRIC SHOCK, OR INJURY TO PERSONS:**

1. Keep away from combustibles. Unplug to change bulb (lamp). Do not touch bulb (lamp).
2. Do not operate without complete bulb (lamp) enclosure in place or if lens is damaged.
3. Unplug and allow to cool before replacing bulb (lamp).
4. Bulb (lamp) gets HOT quickly! Only contact switch/plug when turning on.
5. Do not touch hot lens, guard, or enclosure.
6. Do not remain in light if skin feels warm.
7. Do not look directly at lighted lamp.
8. Keep lamp away from materials that may burn.
9. Use only with a 12V, 50 watt, GY6.35 Tungsten Halogen bulb (lamp).
10. Do not touch the bulb (lamp) at any time. Use a soft cloth. Oil from skin may damage bulb (lamp).
11. Do not operate the portable luminaire with a missing or damaged guard, lamp containment barrier, or UV filter.

## SAVE THESE INSTRUCTIONS

### IMPORTANT

- Read this user manual carefully before you use the appliance and save it for future reference.
- This appliance is double insulated according to Class II (Fig. 1).
- When using an electric appliance, basic precautions should always be followed, including the following:

#### **Danger**

- Water and electricity are a dangerous combination. Do not use this appliance in wet surroundings (e.g. in the bathroom or near a shower or swimming pool).
- Do not let water run into the appliance or spill water onto the appliance (Fig. 2).

#### **Warning**

- Check if the voltage indicated on the appliance corresponds to the local voltage before you connect the appliance.
- The appliance is suitable for voltages of 120V and 60Hz.

- If the power cord is damaged, do not use the appliance. Visit our website: [www.philips.com](http://www.philips.com) or call 1-866-832-4361 for assistance.
- Always let the appliance cool down for approx. 15 minutes before you open the top cap to remove the lamp. The lamp and the metal part of the top cover become hot during use and you may burn your fingers when you touch them. (Fig. 3)
- Close supervision is necessary when this appliance is used by, or near children or invalids.
- Children should be supervised to ensure that they do not play with the appliance.
- This appliance is for indoor use only (Fig. 4).

#### **Caution**

- Do not drop the appliance or expose it to heavy shocks.
- Place the appliance on a stable, level and non-slippery surface.
- Do not use the appliance at room temperatures lower than 50°F/10°C or higher than 95°F/35°C.
- Make sure the vents in the top and in the bottom of the appliance remain open during use.
- Never use the appliance if the lamp housing or top cover is damaged, broken or missing.
- To prevent possible damage to the cord, do not wrap the cord around the appliance.
- Consult your doctor before you start using the appliance if you have suffered from or are suffering from serious depression.
- Do not use this appliance as a means to reduce your hours of sleep. The purpose of this appliance is to help you wake up more easily. It does not diminish your need for sleep.
- The appliance has no on/off switch. To disconnect the appliance from the power source, remove the plug from the wall outlet.
- Use this appliance for its intended household use as described in this manual. Do not use attachments not recommended by Philips Electronics North America Corporation.

#### **General**

- This appliance allows you to choose the light intensity level you want to wake up to (see section 'Using the lamp', chapter 'Using the appliance').
- If you often wake up too early or with a headache, reduce the light level.
- If you share a bedroom with someone else, this person may unintentionally wake up from the light of the appliance, even though this person is further removed from the appliance. This is the result of differences in light sensitivity between people.

#### **FCC Information**

- This device generates and uses radio frequency (RF) energy, and if not installed and used properly, this equipment may cause interference to radio and television reception. These rules are designed to provide reasonable protection against radio and television interference in a residential installation. However, there is no guarantee that interference will not occur in particular installations. If this equipment does cause interference to radio or television reception (which you can determine by unplugging the unit), try to correct the interference by one or more of the following measures: Reorient the receiving antenna (that is, the antenna for the radio or television that is "receiving" the interference). Move the unit away from the equipment that is receiving interference. Plug the unit into a different wall outlet so that the unit and the equipment receiving interference are on different branch circuits. If these measures do not eliminate the interference, please consult your dealer or an experienced radio/television technician for additional suggestions. Also, the Federal Communications Commission has prepared a helpful booklet, "How To Identify and Resolve Radio-TV Interference Problem". This booklet is available from the U.S. Government Printing Office, Washington, DC 20402. Please specify stock number 004-000-00345-4 when ordering copies. This equipment has been type-tested and found to comply with the specifications in Subpart J of Part 15 of FCC Rules.

- This appliance meets the requirements of the low voltage directive 2006/95/EC and the EMC directive 2004/108/EC.

### Introduction

Congratulations on your purchase and welcome to Philips! To fully benefit from the support that Philips offers, register your product at [www.philips.com/welcome](http://www.philips.com/welcome).

The Philips Wake-up Light helps you wake up more pleasantly. The light intensity of the lamp gradually increases to the set level in the 30 minutes before the set wake-up time. The light gently prepares your body for waking up at the programmed time. To make waking up an even more pleasant experience, you can use natural wake-up sounds or the FM radio.

### The effects of the Wake-up Light

The Philips Wake-up Light gently prepares your body for waking up during the last half hour of sleep. In the early morning hours our eyes are more sensitive to light than when we are awake. During that period the relatively low light levels of a simulated natural sunrise prepare our body for waking up and getting alert. People who use the Wake-up Light wake up more easily, have a better overall mood in the morning and feel more energetic. Because the sensitivity to light differs per person, you can set the light intensity of your Wake-up Light to a level that matches your light sensitivity for an optimal start of the day.

For more information about the Wake-up Light, see [www.philips.com](http://www.philips.com).

### General description (Fig. 5)

- A Vents
- B Lamp housing
- C Power cord
- D Antenna
- E Display
- 1 Hour indication of clock time/alarm time
- 2 Clock time symbol
- 3 Alarm symbol
- 4 Radio symbol
- 5 'Birds' sound symbol
- 6 'Beep' sound symbol
- 7 Display brightness symbol
- 8 Sound level symbol
- 9 Radio frequency symbol
- 10 Light symbol
- F Menu '-' button
- G MENU button
- H SELECT button
- I Menu '+' button
- J Control lever with 'alarm off', 'alarm on' and 'snooze' positions
- K Buttons on the side of the appliance
  - 1 Light intensity '+' button
  - 2 Light on/off button
  - 3 Light intensity '-' button
  - 4 Volume increase button
  - 5 Radio on/off button
  - 6 Volume decrease button

### Preparing for use

#### Before first use

- 1 Place the Wake-up Light 16-20in/40-50cm from your head, for example on a bedside table.
- 2 Put the plug in the wall outlet.
  - The hour indication on the display starts flashing to indicate that you have to set the clock time (Fig. 6).

#### Setting the clock time

You cannot use the Wake-up Light until you have set the clock time.

- 1 When the hour indication on the display flashes, press the menu + or – button to set the hour.

*Note: You can only do this when you are in the set clock menu and when the hour indication flashes. If this is not the case, press the MENU button, use the menu + or – button to select the set clock menu and press the SELECT button to confirm. You are now in the set clock menu.*

- 2 Press the SELECT button to confirm.
  - ▶ The minute indication starts flashing (Fig. 7).
- 3 Press the menu + or – button to set the minutes.
- 4 Press the SELECT button to confirm.
  - ▶ The appliance leaves the menu and the display shows the set clock time.

The appliance is now ready for use.

*Note: Every time you remove the plug from the wall outlet for more than approximately 15 minutes, you have to set the clock time again. To change the set clock time when the plug is still in the wall outlet, see section 'Menu functions' in chapter 'Using the appliance'.*

### Using the appliance

Use this appliance for its intended household use as described in this manual.

#### Menu functions

Below find a description of all functions that can be set in the menu. These functions appear in the menu in the following order:

- Clock time
- Alarm time
- Alarm sound
- Display brightness: *You can choose a display brightness between 1 and 4.*

You can set the menu functions in the following way:

- 1 Press the MENU button to enter the menu (Fig. 8).
- 2 Press the menu + or – button to select a function (Fig. 9).
- 3 Press the SELECT button to enter this function (Fig. 10).
- 4 Press the menu + or – button to change a setting (Fig. 9).
- 5 Press the SELECT button to confirm (Fig. 10).

### Using the lamp

You can use the appliance as a bedside lamp.

- 1 To switch on the lamp, press the lamp on/off button (Fig. 11).
- 2 Press the light intensity + and – buttons to select a light intensity (Fig. 12).  
You can choose a light intensity between 1 and 20.

*Note: It takes approx. 1 second for the lamp to go on. This is normal, the lamp needs to heat up.*

*Note: The light intensity you have selected is automatically set as the light intensity level for the alarm as well.*

*Tip: When you use the appliance for the first time, set the light intensity to 20. The moment you wake up, check which light intensity level the appliance has reached by briefly pressing the light intensity + or – button. When you do this, the current alarm light intensity level appears on the display. Set the alarm light intensity to this level for the next day.*

- 3 To switch off the lamp, press the lamp on/off button again.

### Setting the alarm

When you set the alarm, you choose an alarm time and the type of sound you want to wake up to. The alarm is set when the alarm symbol is visible on the display. The light intensity slowly increases to the selected level during the last 30 minutes before the set alarm time. The sound slowly increases in 90 seconds to the selected level after the set alarm time.

*Note: You can set the light intensity by pressing the light on/off button and then pressing the light intensity + or – button and you can set the alarm volume by pressing the volume increase or decrease button. If you do not want to wake up to the lamp or to a sound, set the light intensity or volume level to OFF. See sections 'Using the lamp' and 'Radio/volume' in this chapter.*

- 1 Push the control lever down to the middle position to switch on the alarm (Fig. 13).
  - ▶ The hour indication of the alarm time flashes (Fig. 14).
  - ▶ To adjust the time, follow steps 2 to 5. If the alarm time is correct, just wait a few seconds.

- 2 Press the menu + or – buttons to select the hour (Fig. 9).

*Note: You can only do this when the hour indication flashes. If this is not the case, push the control lever up and down again to enter the alarm time mode. You can also set the alarm time in the menu. See section 'Menu functions' in this chapter.*

- 3 Press the SELECT button to confirm (Fig. 10).
  - ▶ The minute indication of the alarm time starts to flash (Fig. 15).

- 4 Press the menu + and – buttons to select the minutes (Fig. 9).

- 5 Press the SELECT button to confirm or wait for a few seconds (Fig. 10).
  - ▶ The appliance leaves the menu and the display shows the clock time.

The alarm time is now set.

### Switching off the alarm

To switch off the alarm function, push up the control lever to the top position.

*Note: The lamp stays on to light your room. You can switch off the lamp by pressing the light on/off button.*

*Note: The alarm (sound and/or light) automatically switches off after 90 minutes.*

### Setting the alarm sound

See section 'Menu functions'.

You can choose one of the following sounds:

- Radio (Fig. 16)
- Birds (Fig. 17)
- Beep (Fig. 18)

### Snoozing

- 1 Push down the control lever to the bottom position when the alarm goes off (Fig. 19).
  - ▶ The lamp continues to be on at the selected intensity level, but the alarm sound stops. After 9 minutes, the wake-up sound is automatically played again.

*Note: The 9-minute snooze time is fixed. This time cannot be adjusted.*

*Note: If you push down the control lever with too much force, it may jump back to off position.*

### Alarm demonstration

If you want to get a quick demonstration (60 seconds) of the gradually increasing light level and sound level, activate the test function of the appliance.

- 1 Push the control lever down to the bottom position for a few seconds until TEST appears on the display (Fig. 20).
- 2 Push the control lever down again to stop the demonstration.

*Note: The appliance continues to run the alarm demonstration until you push down the control lever again. The test automatically stops after 9 hours.*

### Radio/volume

- 1 To switch on the radio, press the radio on/off button (Fig. 21).
- 2 To select the desired radio frequency, press the menu + and – button (Fig. 9).

*Tip: To scan radio frequencies automatically, press and hold the menu + or – button for approx. 2 seconds.*

*Tip: To make sure you get a good radio signal, fully unwind the antenna and move it around until you have found a position at which reception is best.*

- 3 To switch off the radio, press the radio on/off button again.

### Volume

- 1 To set the volume, press the volume increase or decrease button (Fig. 22).  
You can choose a volume level between 1 and 20.

*Note: The volume level you have selected is automatically set as the volume level for the alarm as well.*

### Setting the display brightness

- 1 Press the MENU button to enter the menu (Fig. 8).
- 2 Press the menu + or – button to select the display brightness menu (Fig. 9).
- 3 Press the SELECT button to enter the display brightness menu (Fig. 10).
- 4 Press the menu + and – button to change the display brightness (Fig. 9).
- 5 Press SELECT to confirm (Fig. 10).



### Cleaning and maintenance

Never use scouring pads, abrasive cleaning agents or aggressive liquids such as alcohol or acetone to clean the appliance.

Regularly remove dust from the outside of the appliance with a dry cloth.

- 1 Always unplug the appliance before you clean it.
- 2 Clean the outside of the appliance with a dry cloth.

Do not let water run into the appliance or spill water onto the appliance (Fig. 2).

### Replacement

The lamp has to be replaced when it stops burning or when the light output decreases. You must replace the lamp with a Philips Halogen lamp, 50W, 12V, GY6.35. Only this lamp provides the correct light intensity.

*Note: This appliance has been designed to be used with self-shielded lamps only (Fig. 23).*  
For more information, see chapter 'Assistance'.

### Replacing the lamp

- 1 Unplug the appliance before you replace the lamp.
- 2 Let the appliance cool down for approx. 15 minutes.
- 3 Unlock the top cover of the appliance by pressing it and turning it counterclockwise, until the O symbol on the top cover is aligned with the symbol ● on the lamp housing (Fig. 24).
- 4 Remove the top cover (Fig. 25).
- 5 Remove the old lamp from the lamp holder (Fig. 26).
- 6 Insert the pins of the new lamp into the lamp holder (Fig. 27).

Do not touch the lamp with your fingers. Use a cloth or paper towel when you replace the lamp (Fig. 28).

- 7 Place the top cover back onto the appliance.
- 8 Lock the top cover by turning it clockwise until the ● symbol on the top cover and the ● symbol on the lamp housing are aligned (Fig. 29).

This appliance has no other user-serviceable parts. For assistance, call 1-866-832-4361.

### Storage

- If the appliance will not be used for an extended period of time, remove the power cord from the wall outlet and store the appliance in a safe, dry location where it will not be crushed, banged, or subject to damage.
- Do not wrap the power cord around the appliance when storing it.

### Disposal

- Dispose of the appliance in accordance with local regulations.
- Your local or national recycling organizations may also have disposal information.
- For assistance go to [www.recycle.philips.com](http://www.recycle.philips.com) or call 1-866-832-4361.

### Assistance

For assistance visit our website: [www.philips.com/support](http://www.philips.com/support) or call toll free: 1-866-832-4361.

### 45-Day Money-Back Guarantee

If you are not fully satisfied with your Philips Wake-up Light, send the product back and we'll refund you the full purchase price.

The Wake-up Light must be shipped prepaid by insured mail, insurance prepaid, have the original sales receipt, indicating purchase price and the date of purchase, and the money-back guarantee return authorization form enclosed. We cannot be responsible for lost mail.

The Wake-up Light must be postmarked no later than 45 days after the date of purchase. Philips reserves the right to verify the purchase price of the Wake-up Light and limit refunds not to exceed suggested retail price.

To obtain a Money-Back Guarantee Return Authorization form, call 1-866-832-4361.

Delivery of refund check will occur 6-8 weeks AFTER receipt of returned product.

### Full Two-Year Warranty

Philips Electronics North America Corporation (USA) and Philips Electronics Ltd (Canada) warrant each new Philips product, model HF3470 against defects in materials or workmanship for a period of two years from the date of purchase, and agree to repair or replace any defective product without charge. IMPORTANT: This warranty does not cover damage resulting from accident, misuse or abuse, lack of reasonable care, or the affixing of any attachment not provided with the product. NO RESPONSIBILITY IS ASSUMED FOR ANY SPECIAL, INCIDENTAL OR CONSEQUENTIAL DAMAGES.

In order to obtain warranty service, simply call toll-free 1-866-832-4361.

In US Manufactured for: Philips Consumer Lifestyle, A Division of Philips Electronics North America Corporation, P.O. Box 10313, Stamford, CT 06904.

In Canada Imported for: Philips Electronics LTD, 281 Hillmount Road, Markham, Ontario L6C 2S3.

PHILIPS is a Registered Trademark of Koninklijke Philips Electronics N.V.

© 2012 Philips Electronics North America Corporation

All Rights Reserved.

### Troubleshooting

This chapter summarizes the most common problems you could encounter with the appliance. If you are unable to solve the problem with the information below, visit our website: [www.philips.com/support](http://www.philips.com/support) or call 1-866-832-4361 for assistance.

Problem	Solution
The appliance does not work at all.	Perhaps the plug is not inserted properly in the wall outlet. Put the plug properly in the wall outlet.
	Perhaps there is a power failure. Check if the power supply works by connecting another appliance.
The appliance functions properly, but the lamp does not work anymore.	Perhaps the lamp has reached the end of its life. The lamp has an expected life of more than 4,000 hours (more than 4 years of normal use). The life depends on the use of the appliance. In case of heavy use, the lamp may not last as long as you expect. If the lamp stops working, go to <a href="http://www.philips.com/support">www.philips.com/support</a> or call 1-866-832-4361 for assistance.

Problem	Solution
The appliance becomes hot during use.	This is normal, as the appliance is heated up by the light of the lamp and the electronics. Always let the appliance cool down, before you replace the lamp.
The appliance does not respond when I try to set different functions.	Remove the plug from the wall outlet and reinsert it. If you reinsert the plug within approximately 15 minutes, the appliance remembers all settings. If you reinsert the plug after a longer period of time, the appliance will go back to factory settings. You need to set all functions again.
The lamp does not go on when the alarm goes off.	Perhaps you set a light intensity level that is too low. Increase the light intensity level.  Perhaps you switched off the alarm by setting the control lever to the top position. To switch on the alarm, set the control lever to the middle position.
The lamp does not go on right away when I switch it on.	It takes approx. 1 second for the lamp to go on. This is normal, the lamp needs to heat up.
I do not hear the alarm sound when the alarm goes off.	Perhaps you set a sound level that is too low. To set a higher sound level, see chapter 'Using the appliance', section 'Radio/volume'.  Perhaps you switched off the alarm by setting the control lever to the top position.  Switch on the radio after you switch off the alarm to check if the radio works. If it does not work, call 1-866-832-4361 for assistance.
The radio does not work.	Call 1-866-832-4361 for assistance.
The radio produces a crackling sound.	Perhaps the broadcast signal is weak. Adjust the frequency (see chapter 'Using the appliance' section 'Radio/volume') and/or change the position of the antenna by moving it around. Make sure you have unwound the antenna completely.
The alarm went off yesterday, but it did not go off today.	Perhaps you switched off the alarm by setting the control lever to the top position.  Perhaps you set a sound level and/or light intensity level that is too low. Set a higher sound and/or light intensity level.  Perhaps there was a power failure that lasted more than approximately 15 minutes. In this case the appliance goes back to factory settings. You need to set all functions again.
The alarm did not go off 9 minutes after I pushed the control lever down to snooze.	Perhaps you pushed the control lever down with so much force that it jumped to off position.  Perhaps you set the volume level to OFF.

Problem	Solution
The light wakes me too early.	Perhaps the light intensity level you have set is not appropriate for you. Try a lower light intensity level if you wake up too early. If light intensity 1 is not low enough, move the appliance further away from the bed.
The light wakes me too late.	Perhaps the appliance is positioned at a lower level than your head. Make sure the appliance is located at a height at which the light is not blocked by your bed, comforter/blanket or pillow. Also make sure the appliance is not placed too far away.  Perhaps the appliance is not suitable for the voltage to which it is connected. Make sure that the voltage indicated on the appliance corresponds to the local voltage.

