

FWM19000

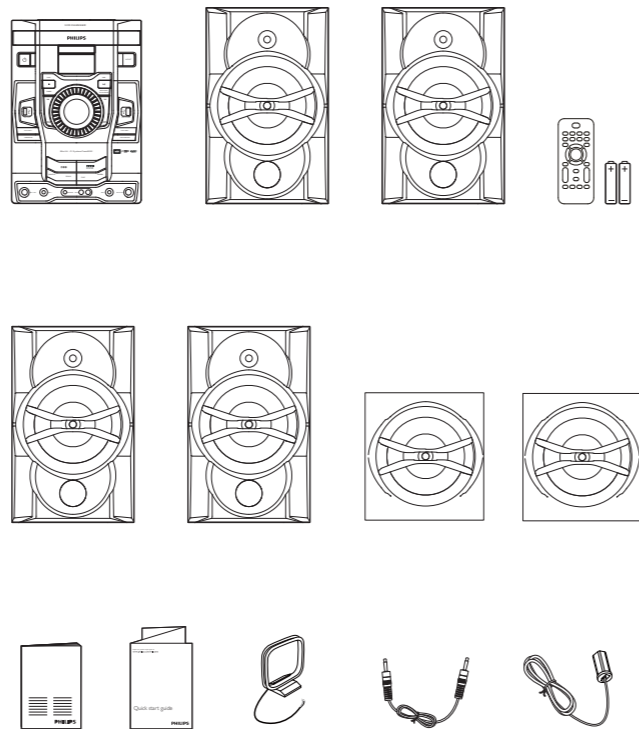

## Guía de inicio rápido

**PHILIPS**



1

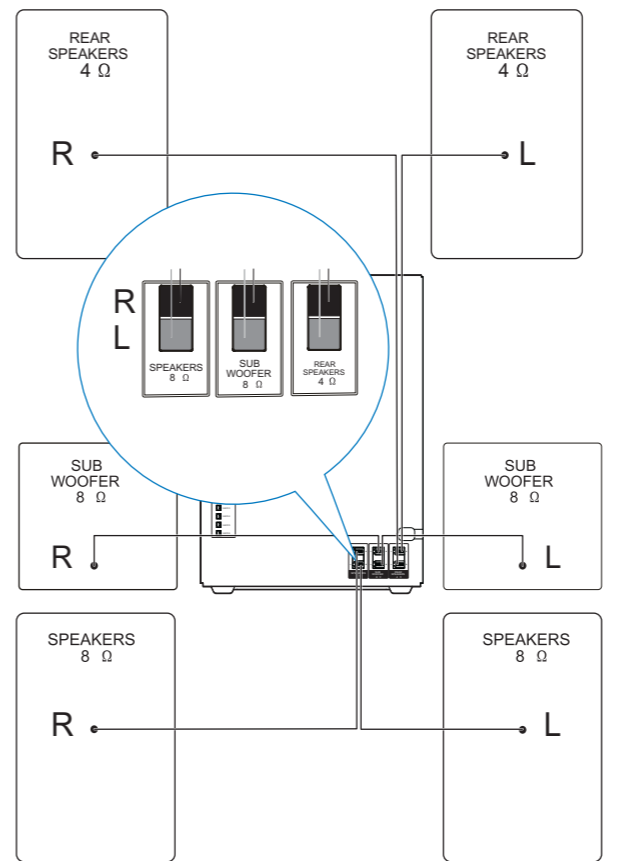

2

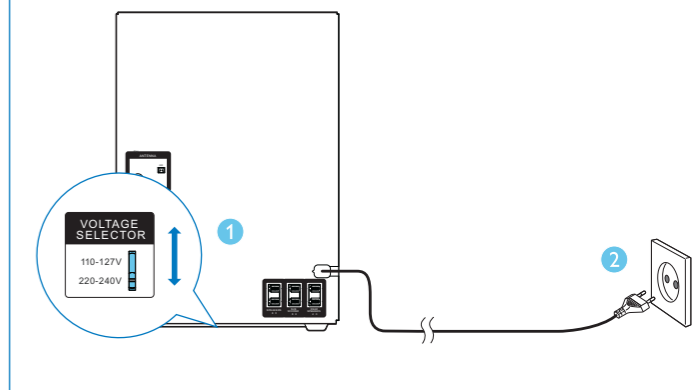

3

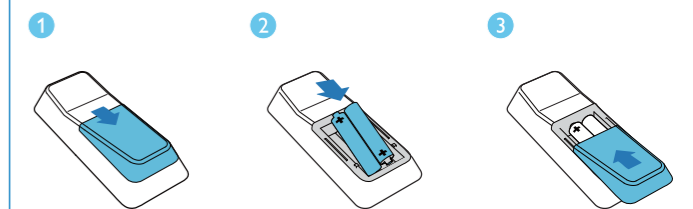

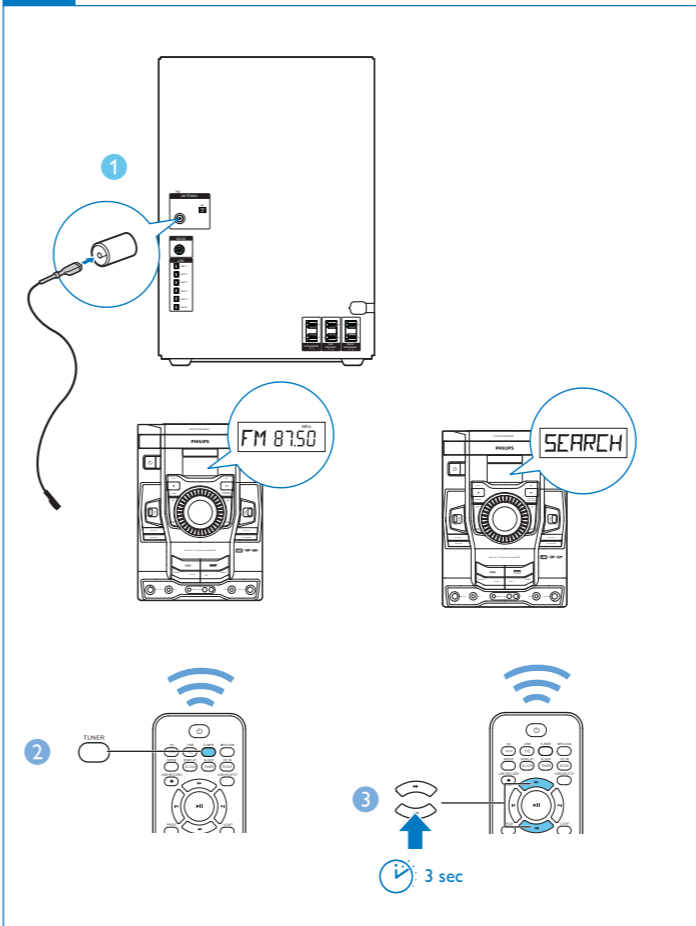
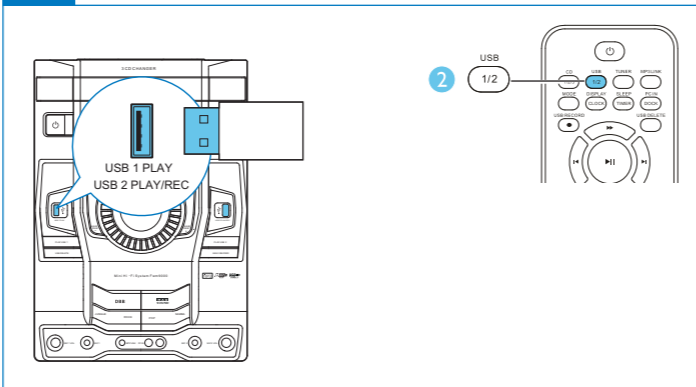
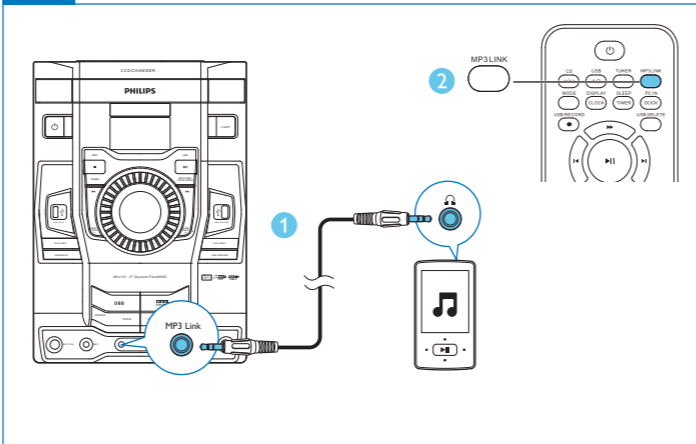
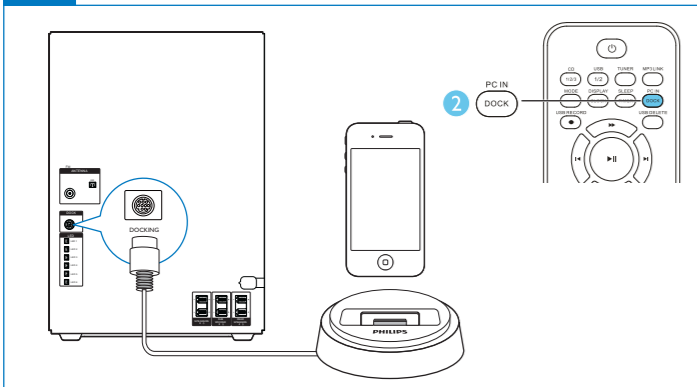
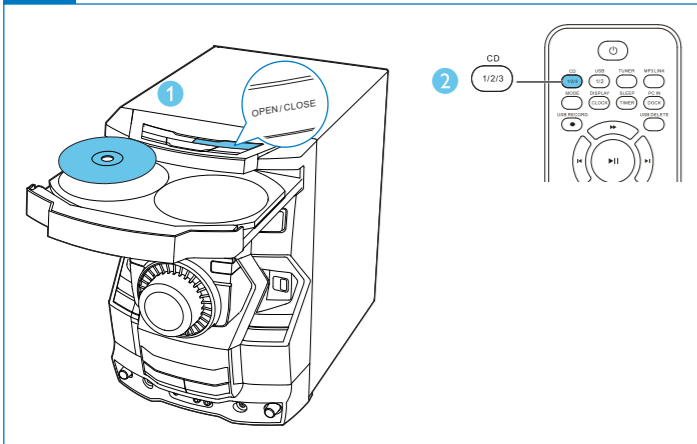

Specifications are subject to change without notice  
©2012 Koninklijke Philips Electronics N.V  
All rights reserved.

FWM9000\_X77\_QSG\_V1.1

