

Register your product and get support at
www.philips.com/welcome

FWM197/12



EN User manual

DA Brugervejledning

DE Benutzerhandbuch

ES Manual del usuario

FR Mode d'emploi

IT Manuale utente

NL Gebruiksaanwijzing

SV Användarhandbok

PHILIPS

Contents

1 Important	4
Safety	4
Notice	6
2 Your Mini Hi-Fi System	8
Introduction	8
What's in the box	8
Overview of the main unit	9
Overview of the remote control	10
3 Get started	12
Connect speakers	12
Install remote control batteries	12
Connect power	13
Set the clock	13
Turn on	13
4 Play	14
Play disc	14
Play from USB	14
5 Play options	15
Repeat play	15
Random play	15
Program tracks	15
6 Listen to the radio	16
Tune to a radio station	16
Program radio stations automatically	16
Program radio stations manually	16
Select a preset radio station	16
7 Play tape	17
8 Adjust sound	18
Adjust volume	18
Select a preset sound effect	18
Enhance bass	18
Mute sound	18
9 Other features	19
Listen to an external device	19
Record from disc	19
Record from radio	19
Record from external source	19
Set the sleep timer	19
Set the alarm timer	20
Listen through headphone	20
10 Product information	21
Specifications	21
USB playability information	22
Supported MP3 disc formats	22
Maintenance	22
11 Troubleshooting	24

1 Important

Safety

Know these safety symbols

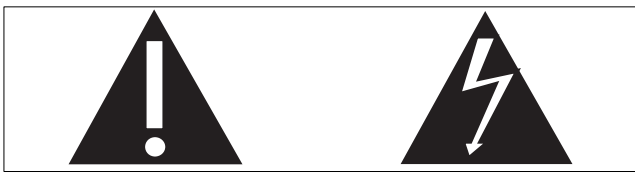
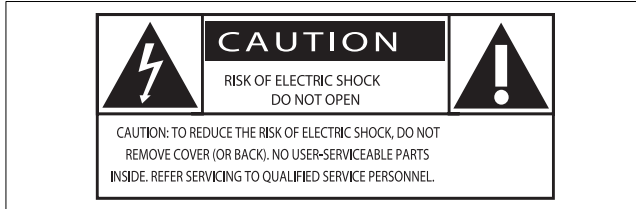

This 'bolt of lightning' indicates uninsulated material within your unit may cause an electrical shock. For the safety of everyone in your household, please do not remove product covering.

The 'exclamation point' calls attention to features for which you should read the enclosed literature closely to prevent operating and maintenance problems. **WARNING:** To reduce the risk of fire or electric shock, this apparatus should not be exposed to rain or moisture and objects filled with liquids, such as vases, should not be placed on this apparatus.

CAUTION: To prevent electric shock, match wide blade of plug to wide slot, fully insert.

- ① Read these instructions.
- ② Keep these instructions.
- ③ Heed all warnings.
- ④ Follow all instructions.
- ⑤ Do not use this apparatus near water.
- ⑥ Clean only with dry cloth.

- ⑦ Do not block any ventilation openings. Install in accordance with the manufacturer's instructions.
- ⑧ Do not install near any heat sources such as radiators, heat registers, stoves, or other apparatus (including amplifiers) that produce heat.
- ⑨ Protect the power cord from being walked on or pinched, particularly at plugs, convenience receptacles, and the point where they exit from the apparatus.
- ⑩ Only use attachments/accessories specified by the manufacturer.
- ⑪ Use only with the cart, stand, tripod, bracket, or table specified by the manufacturer or sold with the apparatus. When a cart is used, use caution when moving the cart/apparatus combination to avoid injury from tip-over.



- ⑫ Unplug this apparatus during lightning storms or when unused for long periods of time.
- ⑬ Refer all servicing to qualified service personnel. Servicing is required when the apparatus has been damaged in any way, such as power-supply cord or plug is damaged, liquid has been spilled or objects have fallen into the apparatus, the apparatus has been exposed to rain or moisture, does not operate normally, or has been dropped.
- ⑭ Battery usage **CAUTION** – To prevent battery leakage which may result in bodily injury, property damage, or damage to the unit:

- Install all batteries correctly, + and - as marked on the unit.
- Do not mix batteries (old and new or carbon and alkaline, etc.).
- Remove batteries when the unit is not used for a long time.

- ⑮ **Apparatus shall not be exposed to dripping or splashing.**
- ⑯ **Do not place any sources of danger on the apparatus (e.g. liquid filled objects, lighted candles).**
- ⑰ **This product may contain lead and mercury. Disposal of these materials may be regulated due to environmental considerations. For disposal or recycling information, please contact your local authorities or the Electronic Industries Alliance: www.eiae.org.**
- ⑱ **Where the MAINS plug or an appliance coupler is used as the disconnect device, the disconnect device shall remain readily operable.**



Warning

- Never remove the casing of this apparatus.
- Never lubricate any part of this apparatus.
- Never place this apparatus on other electrical equipment.
- Keep this apparatus away from direct sunlight, naked flames or heat.
- Never look into the laser beam inside this apparatus.
- Ensure that you always have easy access to the power cord, plug or adaptor to disconnect this apparatus from the power.

Hearing safety

Listen at a moderate volume.

- Using headphones at a high volume can impair your hearing. This product can produce sounds in decibel ranges that may cause hearing loss for a normal person, even for exposure less than a minute. The higher decibel ranges are offered for those that may have already experienced some hearing loss.
- Sound can be deceiving. Over time your hearing 'comfort level' adapts to higher volumes of sound. So after prolonged listening, what sounds 'normal' can actually be loud and harmful to your hearing. To guard against this, set your volume to a safe level before your hearing adapts and leave it there.

To establish a safe volume level:

- Set your volume control at a low setting.
- Slowly increase the sound until you can hear it comfortably and clearly, without distortion.

Listen for reasonable periods of time:

- Prolonged exposure to sound, even at normally 'safe' levels, can also cause hearing loss.
- Be sure to use your equipment reasonably and take appropriate breaks.

Be sure to observe the following guidelines when using your headphones.

- Listen at reasonable volumes for reasonable periods of time.
- Be careful not to adjust the volume as your hearing adapts.
- Do not turn up the volume so high that you can't hear what's around you.
- You should use caution or temporarily discontinue use in potentially hazardous situations. Do not use headphones while operating a motorized vehicle, cycling, skateboarding, etc.; it may create a traffic hazard and is illegal in many areas.

Notice



This product complies with the radio interference requirements of the European Community.

This product complies with the requirements of the following directives and guidelines: 2004/108/EC + 2006/95/EC

Any changes or modifications made to this device that are not expressly approved by Philips Consumer Lifestyle may void the user's authority to operate the equipment.



Be responsible
Respect copyrights

The making of unauthorized copies of copy-protected material, including computer programs, files, broadcasts and sound recordings, may be an infringement of copyrights and constitute a criminal offence. This equipment should not be used for such purposes.

Recycling



Your product is designed and manufactured with high quality materials and components, which can be recycled and reused.

When you see the crossed-out wheel bin symbol attached to a product, it means the product is covered by the European Directive 2002/96/EC:



Never dispose of your product with other household waste. Please inform yourself about the local rules on the separate collection of electrical and electronic products. The correct disposal of your old product helps prevent potentially negative consequences on the environment and human health.

Your product contains batteries covered by the European Directive 2006/66/EC, which cannot be disposed of with normal household waste.

When you see the crossed-out wheel bin symbol with the chemical symbol 'Pb', it means that the batteries comply with the requirement set by the directive for lead:



Please inform yourself about the local rules on separate collection of batteries. The correct disposal of batteries helps prevent potentially negative consequences on the environment and human health.

Environmental information

All unnecessary packaging has been omitted. We have tried to make the packaging easy to separate into three materials: cardboard (box), polystyrene foam (buffer) and polyethylene (bags, protective foam sheet.)

Your system consists of materials which can be recycled and reused if disassembled by a specialized company. Please observe the local regulations regarding the disposal of packaging materials, exhausted batteries and old equipment.



Windows Media and the Windows logo are trademarks, or registered trademarks of Microsoft Corporation in the United States and/or other countries.

This apparatus includes this label:



2 Your Mini Hi-Fi System

Congratulations on your purchase, and welcome to Philips! To fully benefit from the support that Philips offers, register your product at www.philips.com/welcome.

Introduction

With this unit, you can enjoy audio from discs, tapes, USB devices and other external devices, or radio stations.

The unit offers you multiple sound effect settings that enrich sound with Digital Sound Control (DSC) and Dynamic Bass Boost (DBB). The unit supports the following media formats:







What's in the box

Check and identify the contents of your package:

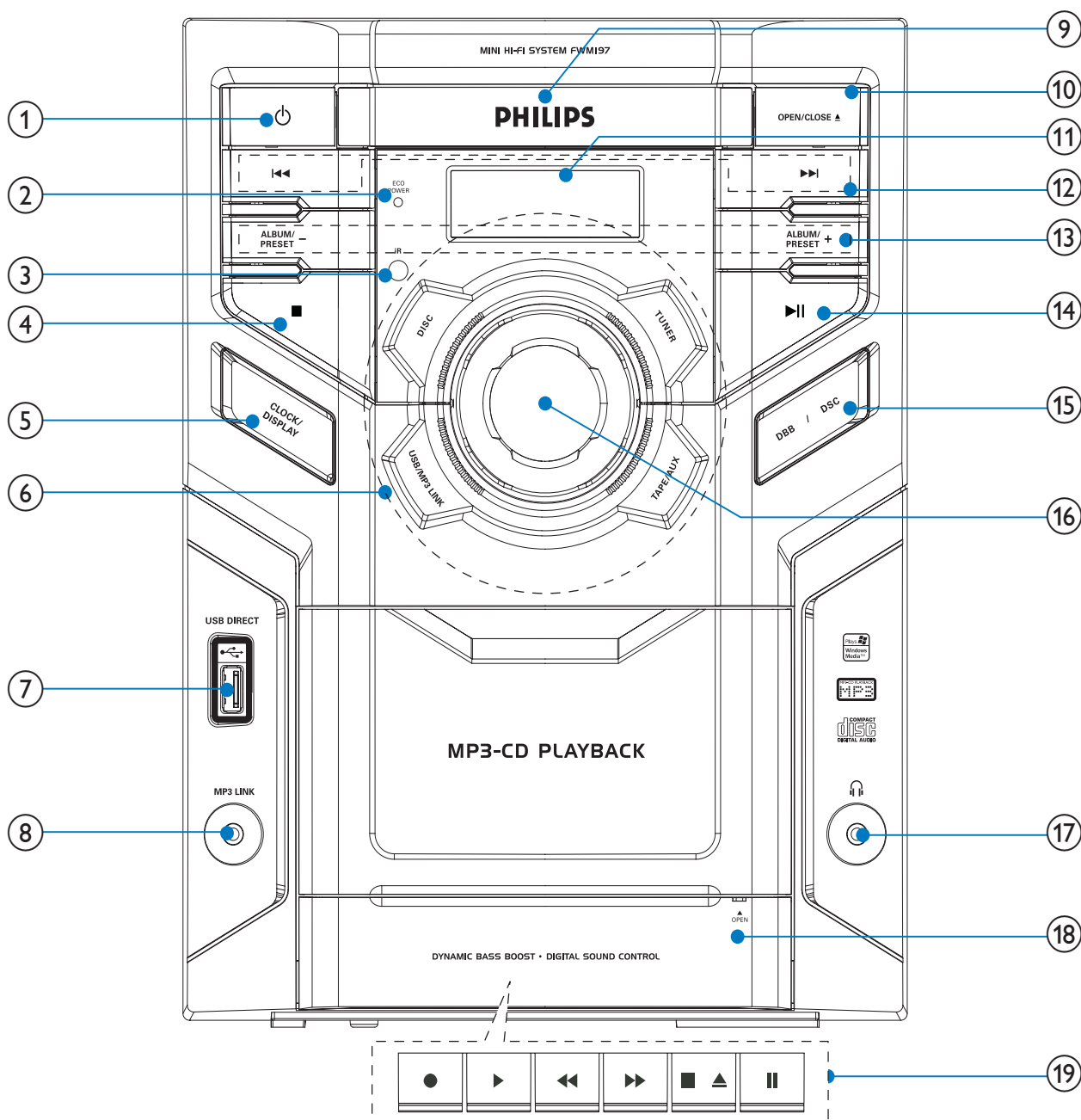
- Main unit
- Speaker box x 2
- Remote control
- MP3 link cable
- User manual
- Quick start guide

Overview of the main unit





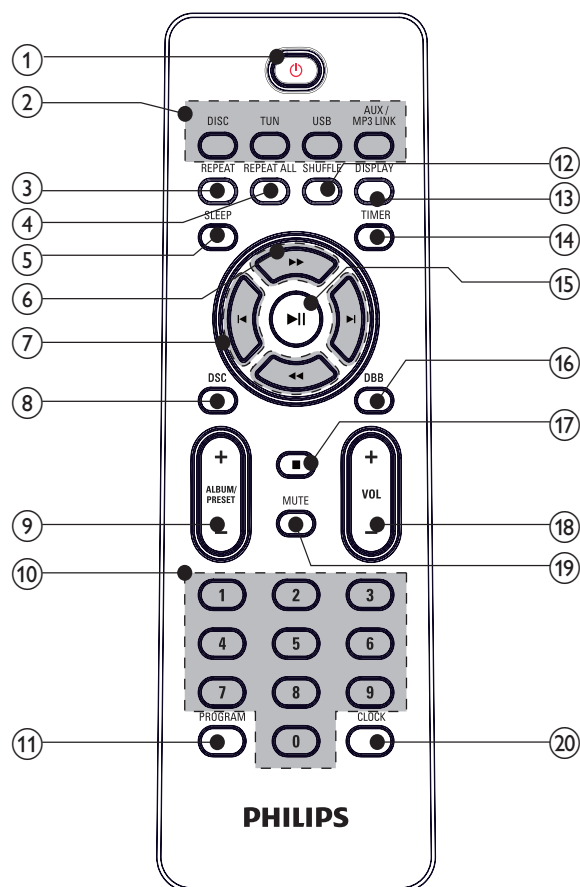

- | | |
|---|---|
| <p>① </p> <ul style="list-style-type: none"> • Turn on the unit, switch to standby mode, or switch to Eco power standby. <p>② ECO POWER indicator</p> <p>③ IR sensor</p> <p>④ </p> <ul style="list-style-type: none"> • Stop play or erase a program. | <p>⑤ CLOCK/DISPLAY</p> <ul style="list-style-type: none"> • Set the clock. • During play, display the clock. <p>⑥ Source buttons (DISC, TUNER, USB, MP3 LINK, TAPE or AUX)</p> <ul style="list-style-type: none"> • Select a source: DISC, TUNER, USB, MP3 LINK, TAPE or AUX. <p>⑦ </p> <ul style="list-style-type: none"> • Jack for a USB mass storage device. |
|---|---|

- ⑧ **MP3 LINK**
 - Audio input jack (3.5mm) for an external audio device.
- ⑨ **Disc compartment**
- ⑩ **OPEN/CLOSE ▲**
 - Open or close the disc compartment.
- ⑪ **Display panel**
 - Show current status.
- ⑫ **⏮⏪⏩⏭**
 - Skip to the previous/next track.
 - Search within a track/ disc.
 - Tune to a radio station.
 - Adjust time.
- ⑬ **ALBUM/PRESET +/-**
 - Select a preset radio station.
 - Skip to the previous/next album.
- ⑭ **▶||**
 - Start or pause play.
- ⑮ **DBB/DSC**
 - Turns on or off dynamic bass enhancement.
 - Select a preset sound setting.
- ⑯ **Volume control**
 - Adjust volume.
- ⑰ **🎧**
 - Connect headphones.
- ⑱ **OPEN**
 - Pull to open the tape button cover.
- ⑲ **Tape controls**
 - ●
Start to record.
 - ▶
Start tape play.
 - ⏮⏩
Fast rewind/forward the tape.
 - ■▲
Stop the tape play or open the tape door.
 - ||
Pause tape play or pause recording.

Overview of the remote control



- ① **⏻**
 - Turn on the unit, switch to standby mode, or switch to Eco power standby.
- ② **Source buttons (DISC, TUN, USB, AUX/MP3 LINK)**
 - Select a source: DISC, TUNER, USB, or AUX/MP3 LINK.
- ③ **REPEAT**
 - Play a track repeatedly.
- ④ **REPEAT ALL**
 - Play all tracks repeatedly.
- ⑤ **SLEEP**
 - Set the sleep timer.

- ⑥ 
- Search within a track/disc.
 - Tune to a radio station.
- ⑦ 
- Skip to the previous/next track.
 - Adjust time.
- ⑧ **DSC**
- Select a preset sound setting.
- ⑨ **ALBUM/PRESET +/-**
- Select a preset radio station.
 - Skip to the previous/next album.
- ⑩ **Numeric keypad**
- Select a track from a disc directly.
 - Select a preset radio station directly.
- ⑪ **PROGRAM**
- Program tracks.
 - Program radio stations.
 - Review the program.
- ⑫ **SHUFFLE**
- Play tracks randomly.
- ⑬ **DISPLAY**
- During play, display the clock.
- ⑭ **TIMER**
- Set the alarm timer.
 - Review the alarm timer.
- ⑮ 
- Start or pause play.
- ⑯ **DBB**
- Turns on or off dynamic bass enhancement.
- ⑰ 
- Stop play or erase a program.
- ⑱ **VOL +/-**
- Adjust volume.
- ⑲ **MUTE**
- Mute volume.
- ⑳ **CLOCK**
- Set the clock.

3 Get started

! Caution

- Use of controls or adjustments or performance of procedures other than herein may result in hazardous radiation exposure or other unsafe operation.

Always follow the instructions in this chapter in sequence.

If you contact Phipps, you will be asked for the model and serial number of this apparatus. The model number and serial number are on the back of the apparatus. Write the numbers here:

Model No. _____

Serial No. _____

Connect speakers

≡ Note

- Ensure that the colors of the speaker wires and terminals are matched.

- 1 Hold down the socket flap.
- 2 Insert the stripped part of the wire completely.
 - Insert the right speaker wires to "HIGH CH R/LOW CH R", left speaker wires to "HIGH CH L/LOW CH L".
 - Insert the red/blue wires to "+", black/grey wires to "-".
- 3 Release the socket flap.

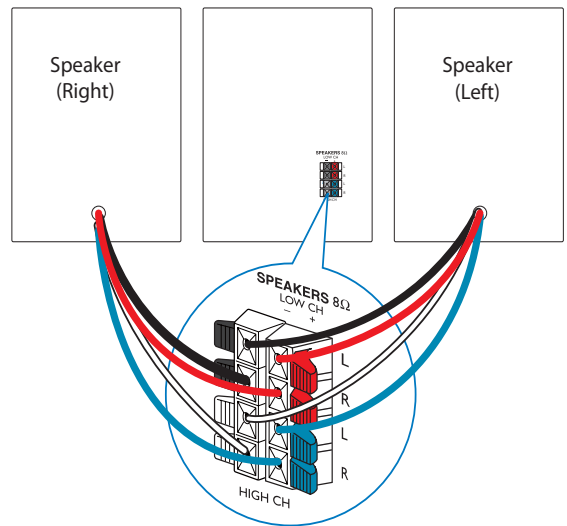
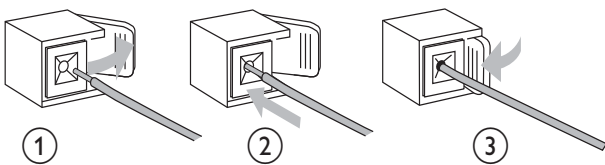

Install remote control batteries

! Caution

- Risk of explosion! Keep batteries away from heat, sunshine or fire. Never discard batteries in fire.
- Risk of decreased battery life! Never mix different brands or types of batteries.
- Risk of product damage! When the remote control is not used for long periods, remove the batteries.

- 1 Open the battery compartment.
- 2 Insert 2 AAA batteries with correct polarity (+/-) as indicated.
- 3 Close the battery compartment.

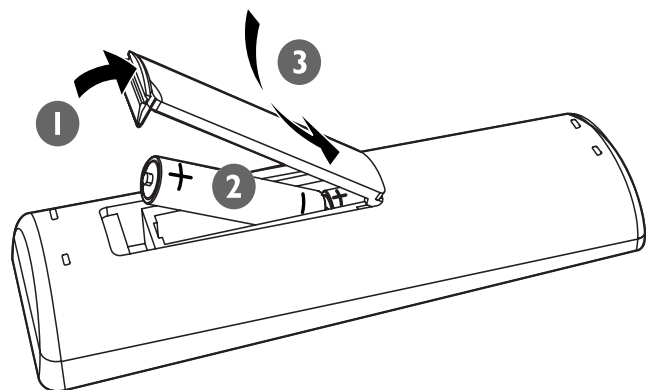

Connect power

! Caution

- Risk of product damage! Ensure that the power supply voltage corresponds to the voltage printed on the back or the underside of the unit.
- Risk of electric shock! When you unplug the AC power cord, always pull the plug from the socket. Never pull the cord.
- Before connecting the AC power cord, ensure you have completed all other connections.

- 1 Connect the power cord to the wall outlet.

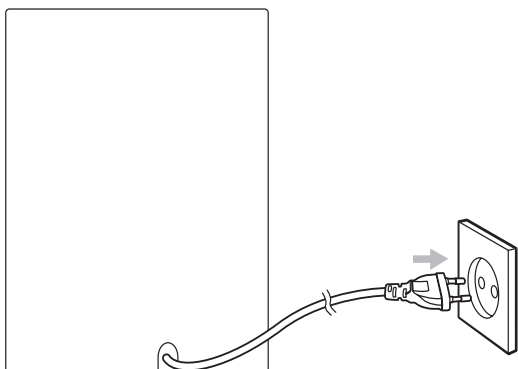

Set the clock

- 1 In standby mode, press and hold **CLOCK**.
 - ↳ The hour digits are displayed and begin to blink.
- 2 Press **◀▶** on the remote control to set the hours.
- 3 Press **CLOCK**.
 - ↳ The minute digits are displayed and begin to blink.
- 4 Press **◀▶** to set the minutes.
- 5 Press **CLOCK** to confirm the time.

* Tip

- During play, you can press **DISPLAY** on the remote control to view the clock.

Turn on

- 1 Press **⏻**.
 - ↳ The unit switches to the last selected source.

Switch to standby

- 1 Press **⏻** to switch the unit to standby mode.
 - ↳ The backlight on the display panel is reduced.
 - ↳ The clock (if set) appears on the display panel.

To switch the unit to Eco Power Standby mode:

- 1 In standby mode, press and hold **⏻** for more than 2 seconds.
 - ↳ The backlight on the display panel turns off.
 - In Eco Power Standby mode, press and hold **⏻** for more than 2 seconds to switch to standby mode.

4 Play

Play disc

- 1 Press **DISC** to select the disc source.
- 2 Press **OPEN/CLOSE ▲** on the front panel to open the disc tray.
- 3 Insert a disc with the printed side facing up, then close the disc tray.
 - ↳ Play starts automatically.
 - To pause/resume play, press ►||.
 - To stop play, press ■.
 - For MP3/WMA disc: to select an album, press **ALBUM/PRESET +/-**.
 - To skip to a track, press ◀/▶.
 - To search within a track, press and hold ◀◀/▶▶. Release to resume normal play.

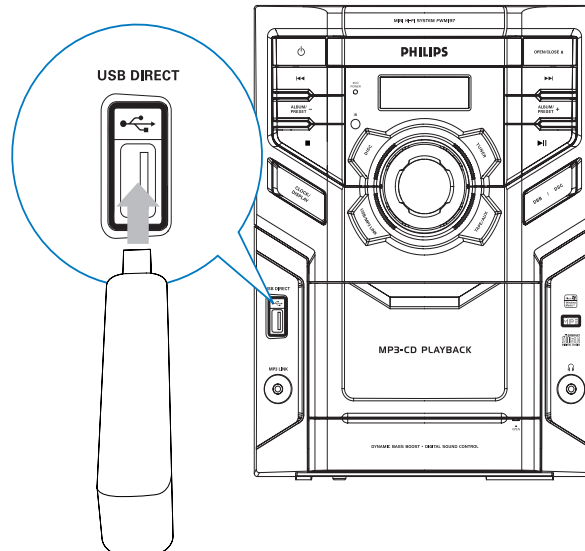

- 2 Press **USB** to select the USB source.
 - ↳ Play starts automatically.
 - To pause/resume play, press ►||.
 - To stop play, press ■.
 - To select an album, press **ALBUM/PRESET +/-**.
 - To skip to a track, press ◀/▶.
 - To search within a track, press and hold ◀◀/▶▶. Release to resume normal play.

Play from USB

Note

- Ensure that the USB device contains playable audio content.

- 1 Connect the USB device into the  socket.

5 Play options

Repeat play

Play a track repeatedly

- 1 During play, press **REPEAT** on the remote control.
↳ [REPEAT] (repeat) is displayed. The current track is played repeatedly.
- 2 To return to normal play, press **REPEAT** again.

Play all tracks or an album repeatedly

- 1 During play, press **REPEAT ALL** on the remote control:
 - [REPEAT ALL] (repeat all) is displayed. All tracks are played repeatedly.
- 2 To return to normal play, press **REPEAT ALL** again.

Random play

- 1 Press **SHUFFLE**.
↳ [SHUF] (shuffle) is displayed. All tracks are played randomly.
- 2 To return to normal play, press **SHUFFLE** again.



Tip

- Shuffle play cannot be selected when you play programmed tracks.
- You can activate [SHUF] (shuffle) and [REPEAT ALL] (repeat all) at the same time.

Program tracks

You can program a maximum of 20 tracks.

- 1 At CD mode, in the stop position, press **PROGRAM** on the remote control to activate the program mode.
↳ [PROG] (program) blinks on the display.
- 2 For MP3/WMA tracks, press **ALBUM/PRESET +/-** to select an album.
- 3 Press **◀/▶** to select a track number, then press **PROGRAM** to confirm.
- 4 Repeat steps 2 to 3 to program more tracks.
- 5 Press **▶||** to play the programmed tracks.
↳ During play, [PROG] (program) is displayed.
 - To erase the program, in the stop position, press **■**.

6 Listen to the radio

Tune to a radio station

Tip

- For optimal FM reception, fully extend and adjust the position of the FM antenna.
- For optimal MW reception, adjust the position of the main unit.

- 1 Press **TUN** on the remote control to select the tuner source.
- 2 Press **TUN** to select FM or MW.
- 3 Press and hold **◀▶** for more than 2 seconds.
 - ↳ [SEARCH] (search) is displayed.
 - ↳ The radio tunes to a station with strong reception automatically.
- 4 Repeat step 3 to tune to more stations.
 - To tune to a weak station, press **◀▶** repeatedly until you find optimal reception.

Program radio stations automatically

Note

- You can program a maximum of 20 preset radio stations.

- 1 In tuner mode, press and hold **PROGRAM** for 2 seconds to activate automatic program mode.
 - ↳ [AUTO] (auto) is displayed and begins to blink.
 - ↳ All available stations are programmed in the order of waveband reception strength.

- ↳ The first programmed radio station is broadcast automatically.

Program radio stations manually

Note

- You can program a maximum of 20 preset radio stations.

- 1 Tune to a radio station.
- 2 Press **PROGRAM** to activate program mode.
 - ↳ [PROG] (program) blinks on the display.
- 3 Press **ALBUM/PRESET +/-** to allocate a number (1 to 20) to this radio station, then press **PROGRAM** to confirm.
 - ↳ The preset number and the frequency of the preset station are displayed.
- 4 Repeat the above steps to program other stations.

Note

- To overwrite a programmed station, store another station in its place.

Select a preset radio station

- 1 In tuner mode, press **ALBUM/PRESET +/-** to select a preset number.

7 Play tape

- 1 Press **TAPE/AUX** on the main unit to select the tape source.
- 2 Pull **OPEN** on the front panel to open the tape button cover.
- 3 Press **■▲** to open the tape door.
- 4 Load the tape with the open side downward and the full spool to the left.
- 5 Press **▶** to start play.
 - To pause/resume play, press **⏸**.
 - To fast rewind/forward the tape, press **◀◀▶▶**.
 - To stop play, press **■▲**.



Note

- When you play or record a tape, the sound source cannot be changed.

8 Adjust sound

Adjust volume

- 1 During play, press **VOL +/-** to increase/decrease the volume.

Select a preset sound effect

- 1 During play, press **DSC** repeatedly to select:
 - [OPTIMAL] (optimal)
 - [JAZZ] (jazz)
 - [TECHNO] (techno)
 - [ROCK] (rock)

Enhance bass

- 1 During play, press **DBB** to turn on or off dynamic bass enhancement.
 - ↳ If DBB is activated, DBB is displayed.

Mute sound

- 1 During play, press **MUTE** to mute/unmute sound.

9 Other features

Listen to an external device

You can also listen to an external audio device through this audio system.

For an audio device with a headphone socket:

- 1 Press **AUX/MP3 LINK** on the remote control repeatedly to select the MP3 link source.
- 2 Connect the supplied MP3 link cable to:
 - the **MP3 LINK** socket on this unit.
 - the headphone socket on an MP3 player.
- 3 Start to play the MP3 player. (See the user manual of the MP3 player)

For other audio devices:

- 1 Press **AUX/MP3-LINK** repeatedly to select the AUX source.
- 2 Connect the audio cables to:
 - the **AUX IN** sockets on this unit.
 - the audio out sockets on the audio device.
- 3 Start to play the device. (See the device user manual)

Record from disc

- 1 Press **DISC** to select the disc source.
- 2 Place a disc on the tray with the printed side facing up.
- 3 Press **■▲** to open the tape compartment.
- 4 Insert a blank tape and close the tape compartment.
- 5 To record from a specific track, press **◀/▶** to select the track.
- 6 To record tracks in a specific sequence, program the tracks (see “**Play options**” > “**Program tracks**”).
- 7 Press **●** to start to record.

- To pause, press **⏸**. To resume, press **⏸** again.
- To stop, press **■▲**.

Record from radio

- 1 Tune to a radio station.
- 2 Press **■▲** to open the tape door.
- 3 Insert a blank tape and close the tape compartment.
- 4 Press **●** to start to record.
 - To pause, press **⏸**. To resume, press **⏸** again.
 - To stop, press **■▲**.

Record from external source

- 1 Press **USB** or **AUX/MP3 LINK** to select an external source.
- 2 Connect the external device.
- 3 Play the selected source.
- 4 Insert a blank tape and close the tape compartment.
- 5 Press **●** to start to record.
 - To pause, press **⏸**. To resume, press **⏸** again.
 - To stop, press **■▲**.

Set the sleep timer

This unit can switch to standby automatically after a set period of time.

- 1 When the unit is turned on, press **SLEEP** repeatedly to select a set period of time (in minutes).
 - ↳ When sleep timer is activated, the display shows **zZ**.

To deactivate sleep timer

- 1 Press **SLEEP** repeatedly until “**SLP OFF**” is displayed.





↳ When sleep timer is deactivated,  disappears on the display.

↳ If timer is activated, the display shows .



↳ If timer is deactivated,  disappears on the display.

Set the alarm timer

This unit can be used as an alarm clock. The last selected source is activated to play at a preset time.

- 1 Ensure that you have set the clock correctly.
- 2 Press and hold **TIMER** on the remote control for more than 2 seconds.
 - ↳ The hour digits are displayed and begin to blink.
- 3 Press   to set the hour.
- 4 Press **TIMER** to confirm.
 - ↳ The minute digits are displayed and begin to blink.
- 5 Press   to set the minute.
- 6 Press **TIMER** to confirm.
 - ↳ The timer is set and activated.

To select a source to activate as the alarm sound:

- 1 Press **DISC**, **TUN**, **USB**, **AUX/MP3 LINK**, or **TAPE/AUX** to select a source.
 - For DISC: ensure that there is a disc in the disc compartment.
 - For TUNER: tune to a radio station.
 - For USB: connect a USB device.
 - For AUX/MP3 LINK: ensure that the external device is connected and turned on.
 - For TAPE: ensure that there is a tape in the tape deck and press the  button.
- 2 Press  to switch the unit to standby.

Activate and deactivate alarm timer

- 1 Press **TIMER** repeatedly to activate or deactivate timer.

Listen through headphone

- 1 Plug a headphone into the  socket on the unit.

10 Product information



Note

- Product information is subject to change without prior notice.

Specifications

Amplifier

Rated Output Power	4X30W RMS
Frequency Response	63 - 16000 Hz, ± 3 dB
Signal to Noise Ratio	>62dB

Disc

Laser Type	Semiconductor
Disc Diameter	12cm/8cm
Support Disc	CD-DA, CD-R, CD-RW, MP3-CD, WMA-CD
Audio DAC	24Bits / 44.1kHz
Total Harmonic Distortion	<1%
Frequency Response	63Hz - 16kHz
S/N Ratio	>65dBA

Tuner

FM

Tuning Range	87.5 - 108 MHz
Tuning grid	50 KHz
Sensitivity	
- Mono, 26dB S/N Ratio	<22 dBu
- Stereo, 46dB S/N Ratio	<45 dBu
Search Selectivity	<28 dBu
Total Harmonic Distortion	<3%
Signal to Noise Ratio	>45 dB

MW

Tuning Range	531 - 1602 kHz
--------------	----------------

Tape deck

Frequency Response	63-8000Hz
- Normal tape (type I)	(8dB)
S/N Ratio	35dBA
- Normal tape (type I)	
Wow and flutter	$\leq 0.4\%$ DIN

Speakers

Speaker Impedance	8ohm
-------------------	------

General information

AC power	220 - 230V, 50Hz
Operation power consumption	55W
Standby power consumption	<2W
Eco Standby power consumption	<1W
USB direct	Version 2.0/1.1
Dimensions	
- Main Unit (W x H x D)	220 x 292 x 285 mm
- Speaker Box (W x H x D)	207 x 292 x 186 mm
Weight	
- With Packing	10.8 kg
- Main Unit	4.3 kg
- Speaker Box	2 x 2.8 kg

USB playability information

Compatible USB devices:

- USB flash memory (USB 2.0 or USB1.1)
- USB flash players (USB 2.0 or USB1.1)
- memory cards (requires an additional card reader to work with this unit)

Supported formats:

- USB or memory file format FAT12, FAT16, FAT32 (sector size: 512 bytes)
- MP3 bit rate (data rate): 32-320 Kbps and variable bit rate
- WMA v9 or earlier
- Directory nesting up to a maximum of 8 levels
- Number of albums/ folders: maximum 99
- Number of tracks/titles: maximum 999
- ID3 tag v2.0 or later
- File name in Unicode UTF8 (maximum length: 128 bytes)

Unsupported formats:

- Empty albums: an empty album is an album that does not contain MP3/WMA files, and will not be shown in the display.
- Unsupported file formats are skipped. For example, Word documents (.doc) or MP3 files with extension .dlf are ignored and not played.
- AAC, WAV, PCM audio files
- DRM protected WMA files (.wav, .m4a, .m4p, .mp4, .aac)
- WMA files in Lossless format

Supported MP3 disc formats

- ISO9660, Joliet
- Maximum title number: 511 (depending on file name length)
- Maximum album number: 511
- Directory nesting up to a maximum of 8 levels
- Supported sampling frequencies: 32 kHz, 44.1kHz, 48 kHz
- Supported Bit-rates: 32~256 (kbps), variable bit rates
- ID3 tag v2.0 or later

Maintenance

Clean the cabinet

- Use a soft cloth slightly moistened with a mild detergent solution. Do not use a solution containing alcohol, spirits, ammonia or abrasives.

Clean discs

- When a disc becomes dirty, clean it with a cleaning cloth. Wipe the disc from the centre out.

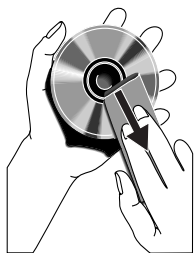

- Do not use solvents such as benzene, thinner, commercially available cleaners, or antistatic spray intended for analogue records.

Clean the disc lens

- After prolonged use, dirt or dust may accumulate at the disc lens. To ensure good play quality, clean the disc lens with Philips CD lens cleaner or any commercially available cleaner. Follow the instructions supplied with cleaner.

Clean the heads and the tape paths

- To ensure good recording and play quality, clean the heads **A**, the capstan(s) **B**, and pressure roller(s) **C** after every 50 hours of tape operation.
- Use a cotton swab slightly moistened with cleaning fluid or alcohol.

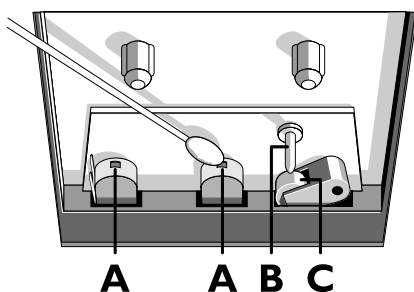

- You can also clean the heads by playing a cleaning tape once.

Demagnetise the heads

- Use a demagnetising tape available at your dealer.

11 Troubleshooting



Warning

- Never remove the casing of this apparatus.

To keep the warranty valid, never try to repair the system yourself.

If you encounter problems when using this apparatus, check the following points before requesting service. If the problem remains unsolved, go to the Philips web site (www.philips.com/welcome). When you contact Philips, ensure that the apparatus is nearby and the model number and serial number are available.

No power

- Ensure that the AC power plug of the unit is connected properly.
- Ensure that there is power at the AC outlet.
- To save power, the system switches off automatically 15 minutes after track play reaches the end and no control is operated.

No sound or poor sound

- Adjust the volume.
- Check that the speakers are connected correctly.
- Check if the stripped speaker wires are clamped.

Left and right sound outputs reversed

- Check the speaker connections and location.

No response from the unit

- Disconnect and reconnect the AC power plug, then turn on the system again.
- As a power-saving feature, the unit switches off automatically 15 minutes after track play reaches the end and no control is operated.

Remote control does not work

- Before you press any function button, first select the correct source with the remote control instead of the main unit.

- Reduce the distance between the remote control and the unit.
- Insert the battery with its polarities (+/- signs) aligned as indicated.
- Replace the battery.
- Aim the remote control directly at the sensor on the front of the unit.

No disc detected

- Insert a disc.
- Check if the disc is inserted upside down.
- Wait until the moisture condensation at the lens has cleared.
- Replace or clean the disc.
- Use a finalized CD or correct format disc.

Poor radio reception

- Increase the distance between the unit and your TV or VCR.
- Fully extend the FM antenna.
- Connect an outdoor FM antenna instead.

Timer does not work

- Set the clock correctly.
- Switch on the timer.

Clock/timer setting erased

- Power has been interrupted or the power plug has been disconnected.
- Reset the clock/timer.

USB device not supported

- The USB device is incompatible with the unit. Try another one.

