

Quick start guide



Step A *Connect*

Step B *Setup*

Step C *Enjoy*

What's in the Box?

You should find these items upon opening the box.

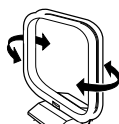

MW antenna

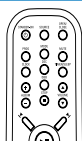

Remote Control

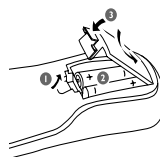

Quick Start Guide

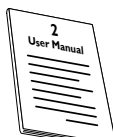

User manual

PHILIPS

Step A *Connect*

- 1 Connect the speaker cables.
- 2 Connect the MW antenna.
- 3 Connect the power cable of the system.

Tip
See the *User Manual* for how to connect other equipment to this system.

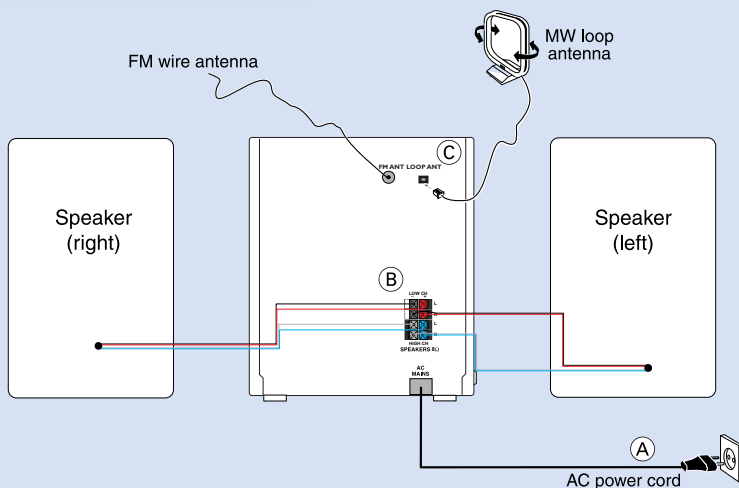

Step B *Setup*

Setting the clock

- 1 In standby mode, press and hold **CLOCK**. The clock digits for the hours flash.
- 2 Adjust the **VOLUME** control knob or press **VOLUME ▲▼** on the remote control to set the hours.
- 3 Press **CLOCK** again. The clock digits for the minutes flash.
- 4 Adjust the **VOLUME** control knob or press **VOLUME ▲▼** on the remote control to set the minutes.
- 5 Press **CLOCK** to confirm the time.

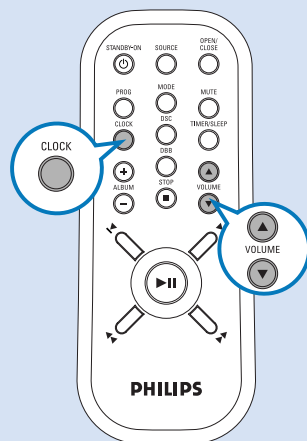

Playing a disc

1

Press **SOURCE** once or more to select **CD**.

2

Press **OPEN/CLOSE** on the system to open the CD compartment.

3

Insert a disc with the printed side facing up and press **OPEN/CLOSE** to close the CD door.

4

Press **▶||** to start playback.

5

Press **STOP ■** to stop playback.

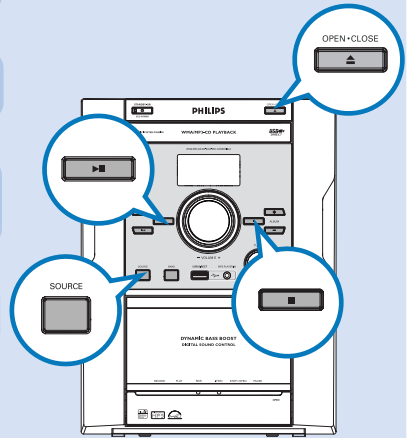

Playing a USB mass storage device

With the Hi-Fi system, you can use USB flash memory (USB 2.0 or USB1.1), USB flash players (USB 2.0 or USB1.1), memory cards (requires an additional card reader to work with this Hi-Fi system).

1

Insert the USB device's USB plug into the socket  on the set.

2

Press **SOURCE** once or more to select **USB**.

3

Play the USB's audio files as you do with the albums/tracks on a CD.

Tip

Detailed playback features and additional functions are described in the accompany user manual.



© Royal Philips Electronics N.V. 2007
All rights reserved.

<http://www.philips.com>

