

# PHILIPS

FW 306 Mini HiFi System

FW 325

FW 326



Instructions for use  
Mode d'emploi  
Instrucciones de manejo  
Bedienungsanleitung  
Gebruiksaanwijzing  
Istruzioni per l'uso  
Bruksanvisning  
Brugsanvisning  
Käyttöohje  
Manual de utilização  
Οδηγίες χρήσεως



**PHILIPS**

## Important notes for users in the U.K.

### Mains plug

This apparatus is fitted with an approved 13 Amp plug. To change a fuse in this type of plug proceed as follows:

- 1 Remove fuse cover and fuse.
- 2 Fix new fuse which should be a BS1362 5 Amp, A.S.T.A. or BSI approved type.
- 3 Refit the fuse cover.

If the fitted plug is not suitable for your socket outlets, it should be cut off and an appropriate plug fitted in its place.

If the mains plug contains a fuse, this should have a value of 5 Amp. If a plug without a fuse is used, the fuse at the distribution board should not be greater than 5 Amp.

**Note:** The severed plug must be disposed of to avoid a possible shock hazard should it be inserted into a 13 Amp socket elsewhere.

### How to connect a plug

The wires in the mains lead are coloured with the following code: blue = neutral (N), brown = live (L).

As these colours may not correspond with the colour markings identifying the terminals in your plug, proceed as follows:

- Connect the blue wire to the terminal marked N or coloured black.
- Connect the brown wire to the terminal marked L or coloured red.
- Do not connect either wire to the earth terminal in the plug, marked E (or  $\frac{1}{2}$ ) or coloured green (or green and yellow).

Before replacing the plug cover, make certain that the cord grip is clamped over the sheath of the lead - not simply over the two wires.

### Copyright in the U.K.

Recording and playback of material may require consent. See Copyright Act 1956 and The Performer's Protection Acts 1958 to 1972.

## Italia

### DICHIARAZIONE DI CONFORMITA'

Si dichiara che l'apparecchio FW306, FW325 e FW326 Philips risponde alle prescrizioni dell'art. 2 comma 1 del D.M. 28 Agosto 1995 n. 548.

Fatto a Eindhoven , il 30/4/1998

Philips Consumer Electronics  
Philips, Glaslaan 2  
5616 JB Eindhoven, The Netherlands

## Norge

Typeskilt finnes på apparatens underside.

**Observer:** Nettbryteren er sekundert innkopleet. Den innebygde nettdelen er derfor ikke frakopleet nettet så lenge apparatet er tilsluttet nettkontakten.

For å redusere faren for brann eller elektrisk støt, skal apparatet ikke utsettes for regn eller fuktighet.

<b>English ..... 4</b>	<b>English</b>
<b>Français ..... 23</b>	<b>Français</b>
<b>Español ..... 45</b>	<b>Español</b>
<b>Deutsch ..... 67</b>	<b>Deutsch</b>
<b>Nederlands ..... 89</b>	<b>Nederlands</b>
<b>Italiano ..... 111</b>	<b>Italiano</b>
<b>Svenska ..... 133</b>	<b>Svenska</b>
<b>Dansk ..... 155</b>	<b>Dansk</b>
<b>Suomi ..... 177</b>	<b>Suomi</b>
<b>Português ..... 197</b>	<b>Português</b>
<b>ελληνικά ..... 219</b>	<b>ελληνικά</b>



**FW 306**

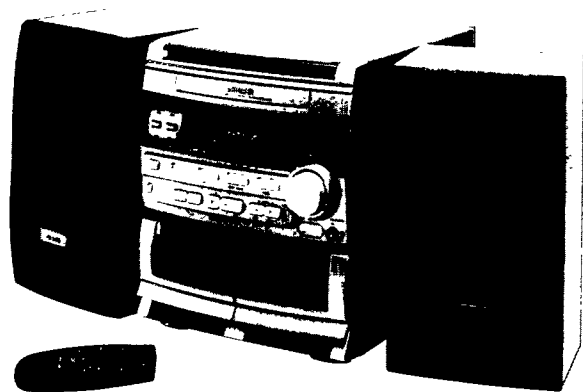

**FW 325  
FW 326**

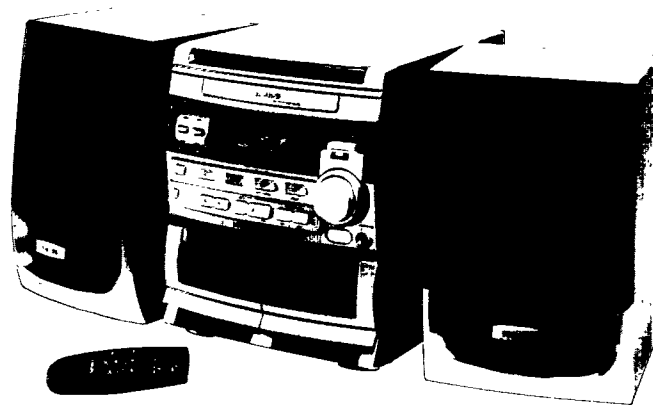

<i>General Information</i> .....	5
<i>Safety Information</i> .....	5
<i>Preparation</i> .....	6 - 7
<i>Controls</i> .....	8 - 9
<i>Operating The System</i> .....	10 - 11
<i>CD</i> .....	12 - 13
<i>Tuner</i> .....	14 - 16
<i>Tape</i> .....	16 - 17
<i>Aux</i> .....	17
<i>Recording</i> .....	18 - 19
<i>Clock</i> .....	19
<i>Timer</i> .....	20
<i>Maintenance</i> .....	21
<i>Specifications</i> .....	21
<i>Troubleshooting</i> .....	22

### General Information

- *The type plate (which contains the serial number) is located at the rear of the system.*
- *Recording is permissible if copyright or other rights of third parties are not infringed.*
- *This product complies with the radio interference requirements of the European Community.*

### Environmental Information

All unnecessary packaging material has been omitted. We have done our utmost to make the packaging easily separable into three mono-materials: cardboard (box), polystyrene foam (buffer) and polythene (bags, protective foam sheet).

Your system consists of materials which can be recycled and reused if disassembled by a specialized company. Please observe the local regulations regarding the disposal of packaging materials, exhausted batteries and old equipment.

### Accessories (Supplied)

- Remote control
- Batteries (2 x AAA size) for remote control
- AM loop antenna
- FM antenna wire
- AC power cord

### Safety Information

- Before operating the system, check that the operating voltage indicated on the typeplate (or the voltage indication beside the voltage selector) of your system is identical with the voltage of your local power supply. If not, please consult your dealer. The type plate is located at the rear of your system.
- When the system is switched on, do not move it around.
- Place the system on a solid base (e.g. a cabinet).
- Place the system in a location with adequate ventilation to prevent internal heat build-up in your system.
- Do not expose the system to excessive moisture, rain, sand or heat sources.
- Under no circumstances should you repair the system yourself, as this will invalidate the warranty!
- If the system is brought directly from a cold to a warm location, or is placed in a very damp room, moisture may condense on the lens of the CD unit inside the system. Should this occur, the CD player will not operate normally. Leave the power on for about one hour with no disc in the system until normal playback is possible.
- Electrostatic discharge may cause unexpected problems. See whether these problems disappear if you unplug the AC power cord and plug it in again after a few seconds.
- **To disconnect the system from the power supply completely, remove the AC power plug from the wall socket.**

# PREPARATION

English

## Rear Connections

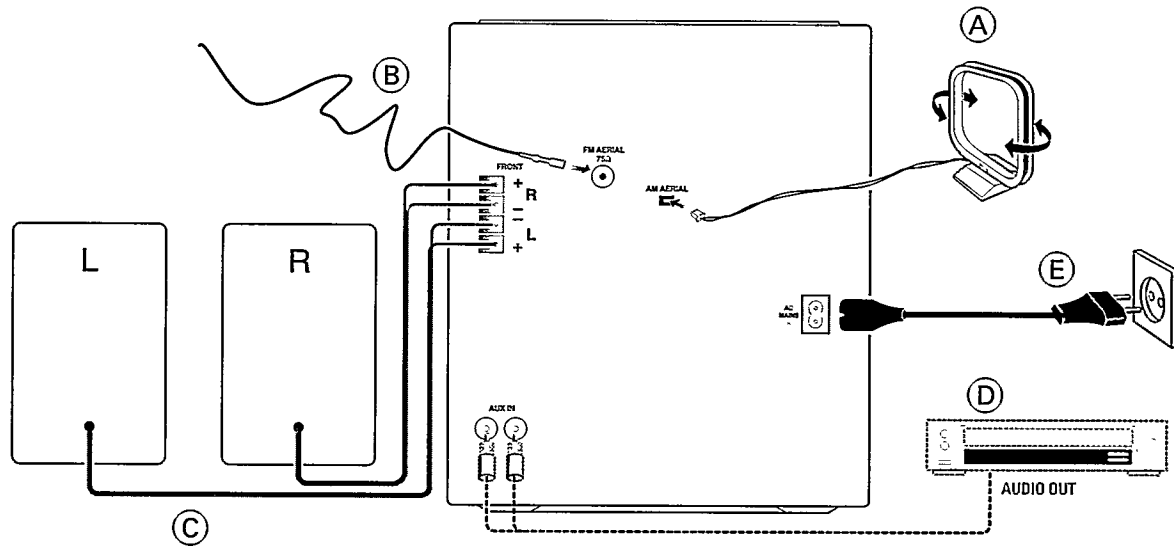

## (A) AM Antenna Connection

Connect the supplied loop antenna to the AM AERIAL terminal. Place the AM loop antenna far away from the system and adjust its position for the best reception.

## (B) FM Wire Antenna Connection

Connect the supplied FM wire antenna to the FM 75 Ω terminal. Adjust the position of the FM antenna for the best reception.

### Outdoor Antenna

For better FM stereo reception connect an outdoor FM antenna to the FM AERIAL 75 Ω terminal using a 75 Ω coaxial wire.

## (C) Speaker Connections

- Connect the right speaker to Front terminal R, with the red wire to + and the black wire to - .
- Connect the left speaker to Front terminal L, with the red wire to + and the black wire to - .
- Clip the stripped portion of the speaker wire as shown.

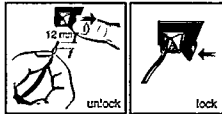

## (D) Connecting other equipment to your system

You can connect the audio left and right OUT terminals of a TV, VCR, Laser Disc or DVD player to the AUX IN terminals at the rear of the system.

## (E) AC Power Supply

After all other connections have been made, connect the AC power cord to the system and to the wall outlet.

## Inserting batteries into the Remote Control

- Insert the batteries (Type R03 or AAA) into the remote control as shown in the battery compartment.

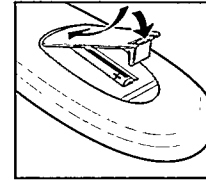

- To avoid damage from possible battery leakage, remove dead batteries or batteries that will not be used for a long time. For replacement, use type R03 or AAA batteries.

# CONTROLS

English

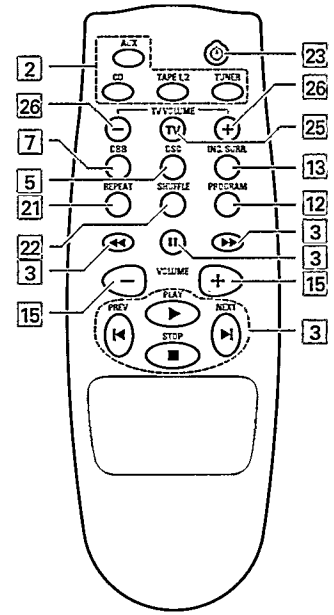
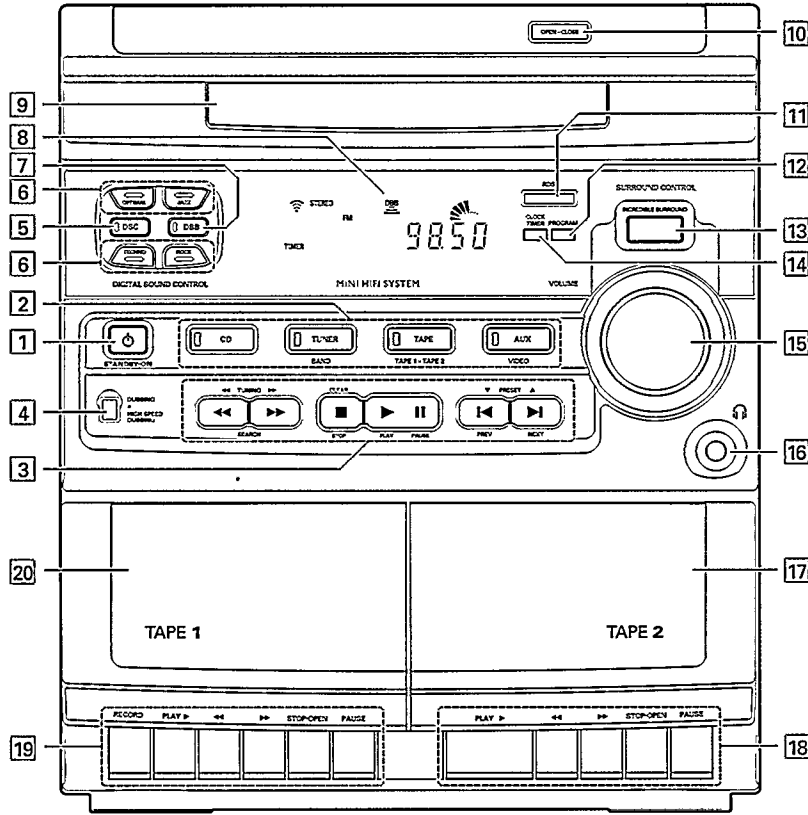

FW 326

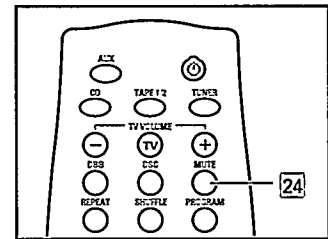



FW 306  
FW 325



## Controls on the system and remote control

- 1** **STANDBY-ON**
  - to switch the system on or to standby mode.
  - to store radio stations automatically by pressing and holding for 2 seconds.
- 2** **SOURCE**: to select the following.
  - CD**
    - to select CD mode.
  - TUNER / (BAND)**
    - to select Tuner mode. When in tuner mode; to select the waveband: FM, MW or LW.
  - TAPE / (TAPE 1•TAPE 2)**
    - to select Tape mode.
  - AUX / (VIDEO)**
    - to select sound from an external source (e.g. TV, Laser Disc, DVD or VCR player).
- 3** **MODE SELECTION**
  - SEARCH ◀◀ ▶▶ (TUNING ◀◀ ▶▶)**
    - for CD ..... to search backward/forward.
    - for TUNER ..... to tune to a lower or higher radio frequency.
  - STOP ■ (CLEAR)**
    - for CD .. ..... to stop CD playback or clear a program.
  - for TUNER ..... to stop programming.
  - PLAY PAUSE ▶ II**
    - for CD ..... to start or interrupt playback.
  - PREV ◀ / NEXT ▶ (PRESET ▲ ▼)**
    - for CD ..... to skip to the beginning of the current or previous/next track.
  - for TUNER ..... to select a preset station in memory.
- 4** **DUBBING**
  - to dub a tape in normal or high speed.

- 5** **DIGITAL SOUND CONTROL (DSC)**
  - to select the desired sound effect : OPTIMAL, JAZZ, ROCK or TECHNO.
- 6** **DIGITAL SOUND CONTROL DISPLAY PANEL**
  - to view the selected DSC display.
- 7** **DYNAMIC BASS BOOST (DBB)**
  - to switch on bass boost to enhance bass response or to switch off bass boost.
- 8** **DISPLAY**
  - to view the current setting of the system.
- 9** **CD TRAY**
- 10** **OPEN•CLOSE**
  - to open or close the CD tray.
- 11** **RDS (available in model FW326 only)**
  - to select RDS data.
- 12** **PROGRAM**
  - to program CD tracks in CD mode or preset radio stations in tuner mode.
- 13** **INCREDIBLE SURROUND (available in model FW326 only)**
  - to switch on or off the surround sound effect.
- 14** **CLOCK•TIMER**
  - to view clock, set clock or timer.
- 15** **VOLUME**
  - to adjust the volume level.
- 16** 
  - to connect headphones.
- 17** **TAPE DECK 2**
- 18** **TAPE DECK 2 OPERATION**
  - PLAY ▶** ..... to start playback.
  - ◀◀** ..... to rewind the tape.
  - ▶▶** ..... to fast forward the tape.
  - STOP•OPEN** ..... to stop playback or to open the tape door.
  - PAUSE** ..... to interrupt playback.

- 19** **TAPE DECK 1 OPERATION**
  - RECORD** ..... to start recording.
  - PLAY ▶** ..... to start playback.
  - ◀◀** ..... to rewind the tape.
  - ▶▶** ..... to fast forward the tape.
  - STOP•OPEN** ..... to stop playback/recording or to open the tape door.
  - PAUSE** ..... to interrupt playback or recording.
- 20** **TAPE DECK 1**
- 21** **REPEAT**
  - to repeat a CD track.
- 22** **SHUFFLE**
  - to play all the tracks in random order.
- 23** 
  - to switch the system to standby mode.
- 24** **MUTE (available in model FW306 and FW325 only)**
  - to switch off the sound temporarily.
- 25** **TV (RC 5 code only)**
  - to select TV mode.
- 26** **TV VOLUME (RC 5 code only)**
  - to adjust the TV volume level.

*Notes for remote control:*

- First select the source you wish to control by pressing one of the source select keys on the remote control (e.g. CD, TUNER, TAPE 1/2 or AUX).
- Then select the desired function (PLAY, NEXT, etc.).

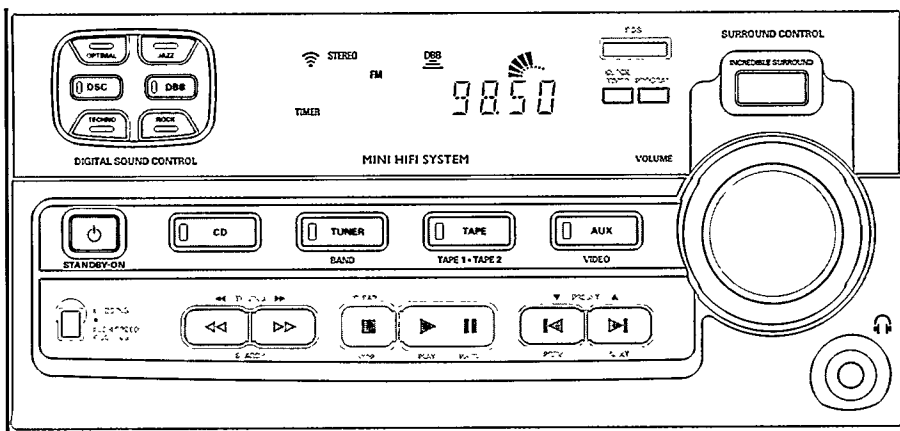

### Important:

Before you begin operating the system, complete the preparation procedures.

### Demonstration mode

The system has a demonstration mode that shows the various features offered by the system. **Whenever the system is switched on from the wall socket, the demonstration mode will start automatically.**

#### Note:

- During demonstration mode, if you press any source (or standby-on) button, the system will switch to the respective (or standby) mode.
- When the system is switched to standby mode, 5 seconds later, the demonstration mode will resume.

### To cancel demonstration mode

- Press and hold **STOP** ■ (on the system only) for **3 seconds** to stop the demonstration.
  - The demonstration mode will be switched off permanently.
  - The system will switch to standby mode.

### Easy Set

EASY SET allows you to store all available radio stations in a particular band (FM, MW or LW) automatically.

- Press and hold **STANDBY•ON** (on the system only) for 2 seconds; when the system is in standby or demonstration mode.
  - "EASY SET" will be displayed and followed by "TUNER".
  - EASY SET will start with the last active band.

- All available radio stations with sufficient signal strength will be stored or until 40 presets are filled.

#### Notes :

- When EASY SET is used, all previously stored stations will be erased.
- The last preset station will appear on the display when EASY SET is completed.

### Switching the system ON

- Press **STANDBY•ON** (on the system only), **CD**, **TUNER**, **TAPE** or **AUX**.

### Switching the system to standby mode

- Press **STANDBY•ON** again.
  - The system will switch to standby mode.

### Selecting the Source

- Press the respective source selection button: **CD**, **TUNER**, **TAPE** or **AUX**.
  - The display indicates the selected source.

#### Note:

- For an external source, make sure that you have connected the audio left and right **OUT** terminals of the external equipment (TV, VCR, Laser Disc or DVD player) to the **AUX IN** terminals.

## Sound Control

### Volume Adjustment

Adjust **VOLUME** to increase or decrease the sound level.

### For Personal Listening

Connect the headphones plug to the  socket at the front of the system. The speakers will be muted.

### Digital Sound Control (DSC)

The DSC feature enables you to enjoy special sound effects that have preset equalizer settings, providing the best music reproduction.

- Press **DIGITAL SOUND CONTROL (DSC)** to select **OPTIMAL, JAZZ, ROCK** or **TECHNO**.
  - The Digital Sound Control display panel will light up respectively.
  - "OPTIMAL, JAZZ, ROCK" or "TECHNO" will be displayed.

### Automatic DSC-DBB selection

The best setting for the DBB is automatically generated for the respective DSC selection. You can manually select the DBB setting that best suits your listening environment.

DSC Selection	DBB On/Off
Optimal	On
Techno	On
Rock	Off
Jazz	Off

### Dynamic Bass Boost (DBB)

The DBB mode enhances the bass response.

- Press **DBB** to switch on bass boost.
  - The DBB button lights up.
  - "DBB ON" will be displayed.

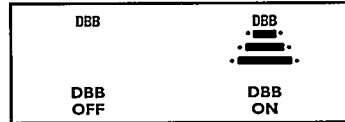

### To switch off DBB

- Press **DBB** again.
  - The DBB button light is switched off.
  - "DBB OFF" will be displayed.

### Note:

- Some CDs or tapes might be recorded in high modulation. It may cause a distortion at high volume. If this occurs, switch off Incredible Surround (if available), DBB level or reduce the volume.

### Incredible Surround (available in model FW326 only)

Normal stereo sound is determined by the distance between the front speakers. When Incredible Surround is switched on, it magnifies the virtual distance between the front speakers for an incredibly wide, enveloping, stereo effect.

- Press **INCREDIBLE SURROUND** to switch on.
  - The INCREDIBLE SURROUND button lights up.
  - "IS" will be displayed.

### To switch off Incredible Surround

- Press **INCREDIBLE SURROUND** again.
  - The INCREDIBLE SURROUND button light is switched off.
  - "IS OFF" will be displayed.

### Mute (available in models FW306 and FW325 remote control only)

This feature allows you to temporarily switch off the sound of the system without switching off the system when you require a moment of silence.

- Press **MUTE** on the remote control to switch off the sound.
  - "MUTE" will be displayed.
- Press **MUTE** again on the remote control or increase the **VOLUME** level to switch on the sound.

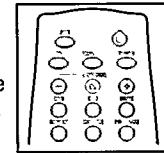

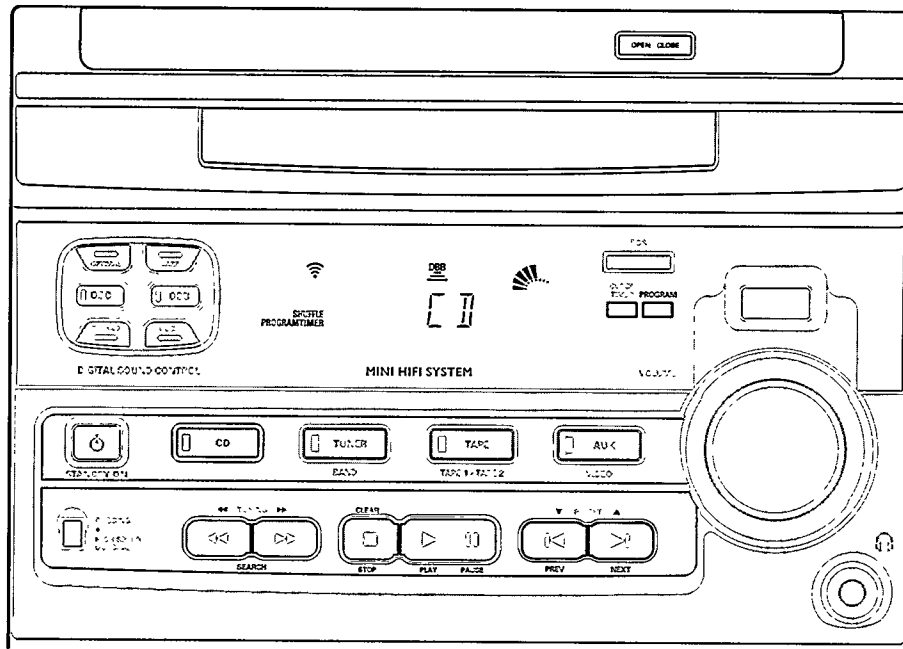

### Warning!

- 1) This system is designed for conventional CDs. Do not use any accessories like disc stabilizer rings or CD treatment sheets, etc., which may damage the CD mechanism.
- 2) Do not load more than one disc into the tray.
- 3) When the CD tray is loaded with a CD, do not turn over or shake the system. This may jam the CD mechanism.

## Loading the CD

- 1 Press **CD** to select CD mode.
- 2 Press **OPEN•CLOSE**.  
→ The CD tray slides out.
- 3 Load a CD with the *printed side up* in the tray.
- 4 Press **OPEN•CLOSE** to close the CD tray.  
→ The total number of tracks and playing time appear on the display.

## Playing a CD

- 1 Press **PLAY ►** to start playback.  
→ The track number and elapsed playing time of the current track appear on the display.
- To interrupt playback, press **PAUSE II**.  
→ The playing time flashes.
- To resume playback, press **PLAY ►** again.
- 2 To stop playback, press **STOP ■**.

### Note:

- When the CD has stopped playing, the system will switch to the standby mode after 15 minutes if no button is pressed.

## Selecting a desired track

### Selecting a desired track at the stop mode

- 1 Press **PREV ◀** or **NEXT ▶** until the desired track appears on the display.
- 2 Press **PLAY ►** to start playback.  
→ The selected track number and elapsed playing time appear on the display.

### Selecting a desired track during playback

- 1 Press **PREV** ◀ or **NEXT** ▶ until the desired track appears on the display.
  - The selected track number and elapsed playing time appear on the display.
- If you press **PREV** ◀ once it will skip to the beginning of the current track and play the track again.

### Searching for a particular passage during playback

- Press and hold ◀◀ or ▶▶ until the desired passage is located.
  - The volume will be reduced.
- Play returns to normal when ◀◀ or ▶▶ is released.

### Programming Tracks

Programming tracks of a loaded CD is possible in the stop mode. The display will indicate the total tracks stored in the program. Up to 20 tracks can be stored in the memory in any order. When 20 tracks are stored and you attempt to store another track, the display will show "PROGRAM FULL"

- 1 Load the desired disc in the disc tray.
- 2 Press **PROGRAM** to start programming.
  - The PROGRAM flag starts flashing.
- 3 Press **PREV** ◀ or **NEXT** ▶ to select the desired track.
- 4 Press **PROGRAM** to store the track.
  - Repeat steps 3 to 4 to store other tracks.
- 5 Press **STOP** ■ once to end programming mode.
  - The total number of tracks programmed and total playing time appear on the display.

### Notes:

- If the total playing time is more than "99:59" or if one of the programmed tracks has a number greater than 30, then "--:--" appears in the display instead of the total playing time.
- During programming, if no button is pressed within 20 seconds, the system will exit program mode automatically.

### Playing the program

- 1 Press **PLAY** ▶ to start program playback.
  - "PLAY PROGRAM" appears on the display.
  - The track number and elapsed playing time of the current track will appear on the display.
- If you press **REPEAT** during program playback, the current track will be played repeatedly.
  - The REPEAT and PROGRAM flags will be displayed.
- 2 Press **STOP** ■ to stop program playback.

### Reviewing the program

Reviewing of the program is only possible in the stop mode.

- Press **PREV** ◀ or **NEXT** ▶ repeatedly to review the programmed tracks.
- Press **STOP** ■ to exit review mode.

### Erasing the program (in the stop mode)

- Press **CLEAR** on the system.
  - "PROGRAM CLEARED" will be displayed.

### Note:

- The program will be erased when the system is disconnected from the power supply. If the CD tray is opened, the program will be erased and the display will show "PROGRAM CLEARED".

### Shuffle (only on remote control)

It will play all the tracks in random order. Shuffle may also be used when tracks are programmed.

#### To shuffle all the tracks

- 1 Press **SHUFFLE**.
  - "SHUFFLE" will be displayed.
  - The SHUFFLE flag, the track selected at random appears on the display.
- The tracks will now be played in random order until you press **STOP** ■.
- If you press **REPEAT** during shuffling, the current track will be played repeatedly.
  - The REPEAT and SHUFFLE flags will be displayed.
- 2 Press **SHUFFLE** again to resume normal playback.
  - The SHUFFLE flag disappears from the display.

### Repeat (only on remote control)

It will play the current track repeatedly.

- 1 Press **REPEAT** during CD playback.
  - "REPEAT TRACK" will be displayed.
  - The REPEAT flag appears on the display.
- The track will now be played repeatedly until you press **STOP** ■.
- 2 Press **REPEAT** again to resume normal playback.
  - The REPEAT flag disappears from the display.

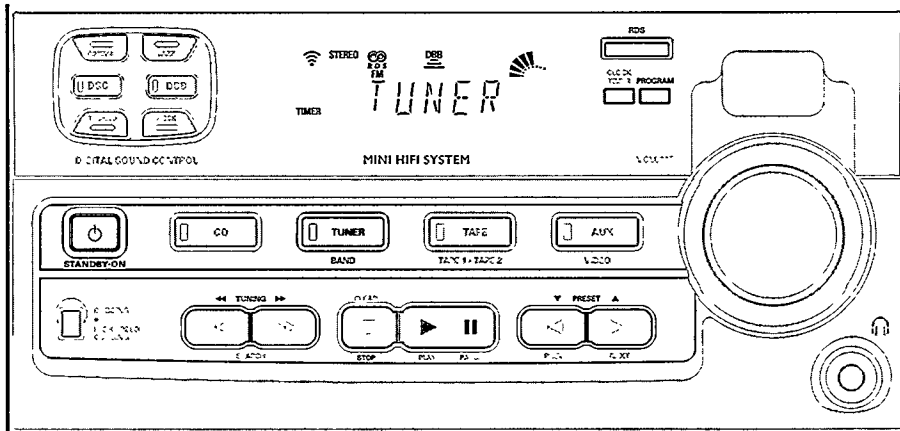

## Easy Set

EASY SET allows you to store all available radio stations and RDS stations in a particular band (FM, MW or LW) automatically.

- 1 Press and hold **STANDBY-ON** (on the system only) for 2 seconds.
  - "EASY SET" will be displayed and followed by "TUNER".
  - Easy set will start with the last active band.
  - All available radio stations with sufficient signal strength will be stored or until 40 presets are filled.

**Searching for RDS stations is only available for model FW326.**

- 2 The system will search once again for the first available RDS station and to set the RDS time automatically.
  - When searching RDS station;
    - "SEARCH RDS STATION" will be displayed. If no RDS station is available, the program will exit automatically and "NO RDS STATION" will be displayed.
    - After a station is found, "EASY SET" will be displayed and followed by "TIME".
  - When searching RDS time;
    - "SEARCH RDS TIME" will be displayed.
    - When RDS time is read, "RDS TIME" will be displayed. The current time is displayed for 2 seconds and will be stored automatically.

## Notes :

- When EASY SET is used, all previously stored stations will be erased.
- The last preset station or the first available RDS will appear on the display when Easy Set is completed.
- If RDS station does not transmit RDS time within 90 seconds, the program will exit automatically and the display will show "NO RDS TIME".

## Tuning to radio stations

- 1 Press **TUNER** to select TUNER mode.
    - "TUNER" will be displayed.
    - A few seconds later, the current frequency or the radio station name if available will be displayed.
  - 2 Press **TUNER (BAND)** again to select the desired waveband : FM, MW or LW.
  - 3 Press **TUNING** **◀◀** or **▶▶** for more than one second, then release.
    - The display will show "SEARCH" until a radio station with sufficient signal strength is found.
- Repeat this procedure until the desired station is reached.
  - To tune to a weak station, briefly press **TUNING** **◀◀** or **▶▶** until the display shows the desired frequency and/or when the best reception has been obtained.

## Storing Preset Stations

You can store up to 40 radio stations in the memory. When a preset radio station is selected, the preset number appears next to the frequency on the display.

### Automatic programming

- 1 Press **TUNER**.
- 2 Press **TUNER (BAND)** again to select the desired waveband : FM, MW or LW.
- 3 Press **PROGRAM** for more than one second.
  - PROGRAM flag starts flashing and "RUTQ" will be displayed.
  - Every available station for the selected waveband will be stored automatically. The frequency and preset number will be displayed briefly.
  - The system will stop searching when all the available radio stations are stored or when the memory for 40 preset radio stations is used.
  - The system will remain tuned to the last stored preset radio station.

- Repeat the above procedure to store other preset radio stations for the other waveband. Remember to select the next available preset number before proceeding. If not, some of the preset radio stations may be erased.

### Notes:

- You can cancel the automatic programming by pressing **PROGRAM** or **STOP ■** (on the system only).
- If you want to reserve a section of preset numbers, for example preset numbers 1 to 9, select preset 10 before starting automatic programming: now only the preset numbers 10 to 40 will be programmed.

### Manual programming

- 1 Press **TUNER**.
  - 2 Press **TUNER (BAND)** to select the desired waveband : FM, MW or LW.
  - 3 Press **PROGRAM** for less than one second.
    - PROGRAM flag, the frequency and preset number start flashing.
    - The next available preset number will be displayed for selection.
  - 4 Press **TUNING ◀◀** or **▶▶** to tune to the desired frequency.
    - If you wish to store the radio station to another preset number, press **PRESET ▼** or **▲** to select the desired preset number.
  - 5 Press **PROGRAM** again.
    - PROGRAM flag will stop flashing, and the radio station will be stored.
- Repeat the above procedure to store other preset radio stations.

### Notes:

- When 40 radio stations are stored and you attempt to store another radio station, the display will show "PROGRAM FULL". If you want to change an existing preset number, repeat steps 4 and 5.
- You can cancel manual programming by pressing **STOP ■** (on the system only).
- During programming, if no button is pressed within 20 seconds, the system will exit program mode automatically.

## Tuning to Preset Radio Stations

- Press **PRESET ▼** or **▲** to select the desired preset number.
  - The preset number, frequency and waveband appear on the display

## Receiving RDS radio station

(for model FW326 only)

RDS (Radio Data System) is a broadcasting service that allows FM stations to send additional information along with the regular FM radio signal. This additional information can contain:

- **STATION NAME:** The station name is displayed.
- **FREQUENCY:** The frequency of the station is displayed.
- **PROGRAM TYPE:** The following program types exist and can be received by your tuner: News, Affairs, Info, Sport, Educate, Drama, Culture, Science, Varied, Pop M, Rock M, M.O.R. (middle of the road music), Light M, Classics, Other M, No type.
- **RADIO TEXT (RT):** text messages appear in the display.

When you have tuned to a RDS station, the RDS logo  and the station name will appear on the display:

- The display normally shows the radio station name if available. By repeatedly pressing **RDS** button you can change the type of display information:
  - The display shows in turn:  
STATION NAME → FREQUENCY →  
PROGRAM TYPE → RADIO TEXT →  
STATION NAME ...

**Note:**

- When you press the RDS button and the display shows "NO RDS", it indicates that either the tuned station is not transmitting RDS signal or it is a non RDS station.

**RDS Time**

Some RDS station may be transmitting a real time clock at an interval of every minute.

**Setting the time with RDS clock****1 Press CLOCK•TIMER.**

→ " - : - : " or current time appears on the display.

**2 Press CLOCK•TIMER once more to enter clock setting mode.**

→ "00:00" or current time starts flashing.

**3 Press RDS.**

→ The message "SEARCH RDS TIME" will be displayed.

→ If the station does not transmit RDS clock, "NO RDS TIME" will be displayed.

→ When the RDS clock is read, "RDS TIME" will be displayed. The current clock time is displayed for 2 seconds and will be stored automatically.

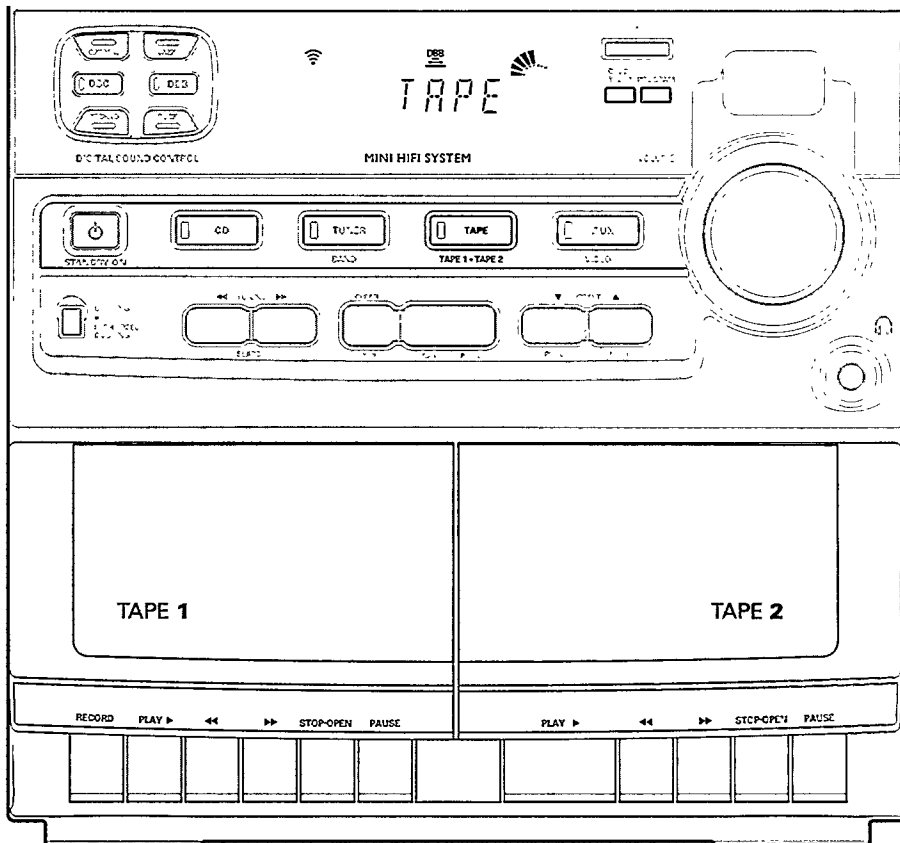



## Loading a tape

- Press **STOP•OPEN**.
- The tape deck door opens.
- Load the tape with the open side downward and the full spool to the left.
- Close the tape deck door.

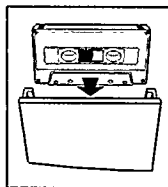

## Tape Playback

- 1 Press **TAPE** to select TAPE mode.  
→ "TAPE" will be displayed.
- 2 Load the tape into the selected tape deck.
- 3 Press **PLAY ►** to start playback.
  - To interrupt playback, press **PAUSE**.
  - To resume playback, press **PAUSE** again.
- 4 Press **STOP•OPEN** to end playback.

## Rewind/Fast Forward

### At the stop mode

- 1 You can rewind or fast forward a tape by pressing **◀◀** or **▶▶** respectively.  
→ The tape will stop automatically at the end of rewinding or fast forwarding.
- 2 Press **STOP•OPEN** to stop rewinding or fast forwarding.

## Continuous Playback From Tape Deck 2 to Tape Deck 1

- 1 Press **TAPE** to select TAPE mode.
- 2 Load the tapes in **tape deck 1** and **2**.
- 3 Press **PLAY ►** on **tape deck 2**.
- 4 Press **PAUSE** on **tape deck 1**.
- 5 Press **PLAY ►** on **tape deck 1**.  
→ Playback will begin with tape deck 2 and will continue with tape deck 1 when playback on tape deck 2 ends.
- 6 Press **STOP•OPEN** if you want to stop playback before the end of the tape in **tape deck 1** or **tape deck 2**.

### Notes:

- During rewinding or fast forwarding of a tape, it is also possible to select another source mode (e.g. CD, TUNER or AUX mode).
- Check and tighten slack tape before use with a pencil. Slack tape may get jammed or may burst in the mechanism.
- C-120 tape is extremely thin and is easily deformed or damaged. It is not recommended for use in this system.
- Store the tapes at room temperature and do not put them too close to a magnetic field (for example, a transformer, TV or loudspeaker boxes).

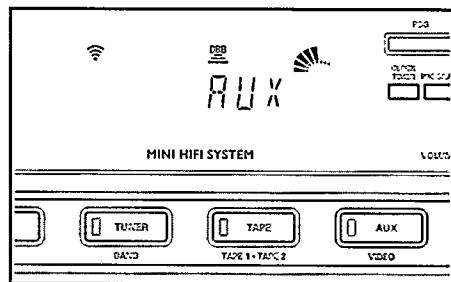

## Selecting External Equipment

If you have connected the audio out terminals of the external equipment (TV, VCR, Laser Disc or DVD player) to the AUX IN terminals, you can hear the enhanced sound from the system.

- Press **AUX** to select the external mode.  
→ "AUX" will be displayed.

### Note:

- All the sound control features (e.g. DSC, DBB, etc.) are available for selection.

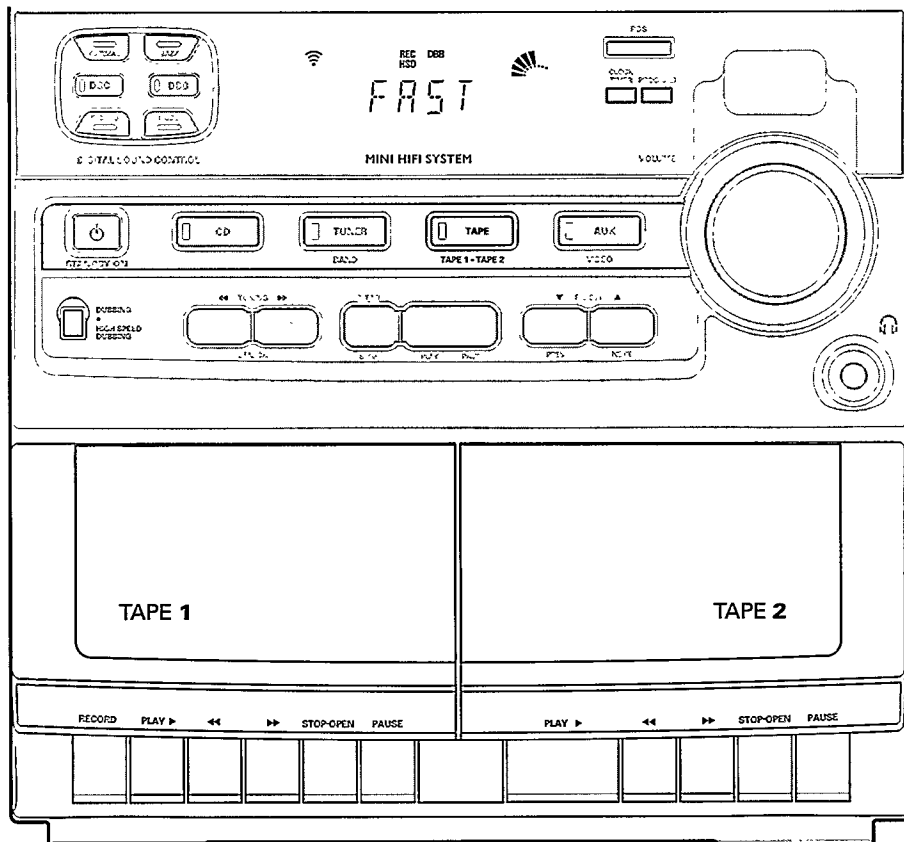

**Notes:**

- For recording, use only tape of IEC type I (normal tape).
- The tape is secured at both ends with leader tape. At the beginning and end of tape, nothing will be recorded for six to seven seconds.
- The recording level is set automatically, regardless of the position of VOLUME, DBB or Incredible Surround (if available).
- To prevent accidental recording, break out the tab on the left shoulder of the tape side you want to protect.

## One Touch Recording

- For One Touch Recording, as soon as you press RECORD, the current source will be recorded on tape deck 1.

- 1 Load a blank tape in tape deck 1.
- 2 Press **RECORD** on tape deck 1 to start recording.  
→ The REC flag starts flashing.
- 3 Press **PAUSE** to interrupt recording.
- 4 Press **STOP•OPEN** on tape deck 1 to stop recording.

## Dubbing tapes (from tape deck 2 to tape deck 1)

- 1 Load the prerecorded tape into tape deck 2 and a blank tape into tape deck 1.  
→ Make sure that both tapes have their full spool to the left.
- 2 Press **DUBBING** to switch between normal and high speed dubbing.  
→ "NORMAL" (normal speed) or "FAST" (high speed) will be displayed.  
→ HSD flag appears on the display for high speed dubbing.

- 3 Press **PAUSE** on tape deck 1.
- 4 Press **RECORD** on tape deck 1.
- 5 Press **PLAY** on tape deck 2.
  - Recording will start automatically.
  - The REC flag starts flashing.
- 6 Press **STOP•OPEN** on tape deck 1 and tape deck 2 to stop dubbing.

**Notes:**

- At the end of side A, flip the tapes to side B and repeat the procedure.
- Dubbing of tapes is only possible from tape deck 2 to tape deck 1.
- To ensure good dubbing, use tapes of the same length.
- During high speed dubbing in Tape mode, the sound is reduced to a low volume.

**CD Synchro Start Recording**

During CD synchro start recording,

- It is not advisable to fast forward/rewind your tape in tape deck 2.
  - It is not possible to listen to another source.
- 1 Load a blank tape into tape deck 1 and a disc into the disc tray.
  - 2 Press **CD**.
    - You can program the tracks in the order you want them to be recorded (see Programming Tracks). If not, the tracks are recorded according to the disc.
  - 3 Press **RECORD** on tape deck 1 to start recording.
  - 4 Press **STOP•OPEN** on tape deck 1 to stop recording and **STOP ■** to stop CD playback.

**Recording from other sources (only on tape deck 1)**

- 1 Load a blank tape into tape deck 1.
- 2 Press **CD, TUNER** or **AUX**.
  - Start playback of the selected source.
- 3 Press **RECORD** on tape deck 1 to start recording.
  - The REC flag is flashing.
- 4 Press **PAUSE** to interrupt recording.
- 5 Press **STOP•OPEN** on tape deck 1 to stop recording.

**Note:**

- During recording, it is not possible to listen to another sound source.

**View Clock**

You can view the clock (if it is set) at standby or any source mode. It will be displayed for about 7 seconds.

- Press **CLOCK•TIMER** briefly.
  - "10:25" (the current time) will be displayed.
  - "----" will be displayed if the clock is not set.

**Clock Setting**

The clock is set in 24-hour mode, e.g. "00:00" or "23:59". Before setting the clock, you must be in the View Clock mode.

- 1 Press **CLOCK•TIMER** to select clock mode.
  - "00:00" or the current time starts flashing.
  - "◀◀, ▶▶, ◀, ▶, ■" light up (for models FW325 and FW326 only).
- 2 Set the hour with **◀◀** or **▶▶**.
- 3 Set the minute with **◀** or **▶**.
- 4 Press **CLOCK•TIMER** again to store the setting.
  - The clock starts running.
- To exit without storing the setting, press **STOP ■**.

**Notes:**

- During clock setting, if no button is pressed within 90 seconds, the system will exit clock setting mode automatically.
- When a power interruption occurs, the clock setting is erased.
- To set the time with RDS clock, see "Receiving RDS Radio Station" under TUNER section. (for model FW326 only)

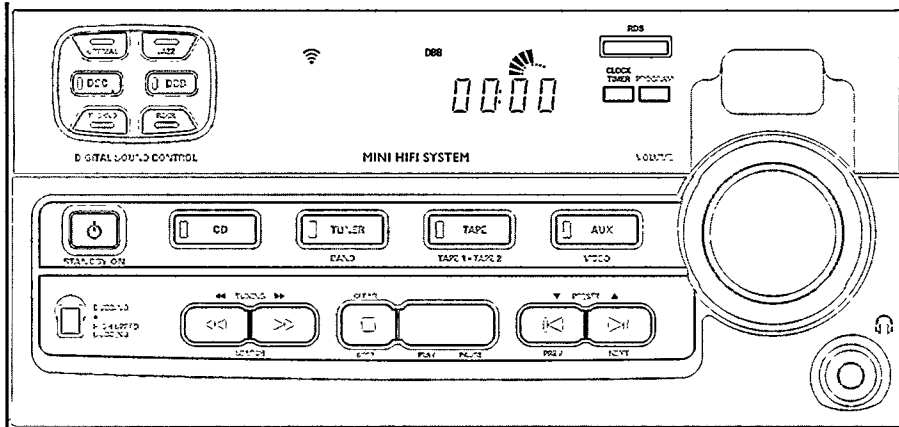

## Timer Setting

- The system can switch on to CD or TUNER mode automatically at a preset time. It can serve as an alarm to wake you up. After half an hour from the preset time, the system will return to the standby mode if no button is pressed.
- Before setting the timer, make sure the clock is set correctly.
- The timer has to be reset or start again for each subsequent preset time.
- **The volume of the timer will be at the last setting before the set is switched to standby mode.**

- 1 Press and hold **CLOCK•TIMER** for more than 2 seconds to select timer mode.
    - "ON 00:00" or the last set timer starts flashing. The TIMER flag flashes.
    - The last selected source is lighted while other available sources are flashing.
    - "◀◀, ▶▶, ◀, ▶, ■" light up (for models FW325 and FW326 only).
  - 2 Press **CD** or **TUNER** to select the desired source.
  - 3 Press **◀◀** or **▶▶** to set the hour for the timer to start.
  - 4 Press **◀** or **▶** to set the minute for the timer to start.
  - 5 Press **CLOCK•TIMER** to store the start time.
    - The TIMER is now set.
    - The TIMER flag remains on the display.
- To exit without storing the setting, press **STOP ■**.

- At the preset time, the **TIMER** will be activated.
  - The selected source will be played.
  - The **TIMER** flag disappears from the display.

### Notes:

- During timer setting, if no button is pressed within 90 seconds, the system will exit timer setting mode automatically.
- If the source selected is **TUNER**, the last tuned frequency will be switched on.
- If the source selected is **CD**, the first track of the disc will be played. If the **CD** tray is empty, the **TUNER** source will be selected instead.

### To cancel the **TIMER**

- 1 Press **CLOCK•TIMER** for more than 2 seconds.
- 2 Press **PAUSE** to cancel the timer.
  - "CANCEL" will be displayed.
  - The **TIMER** flag disappears from the display.

### To start the **TIMER** again (for the same time)

- 1 Press **CLOCK•TIMER** for more than 2 seconds.
- 2 Press **CLOCK•TIMER** again to store the start time and the selected source.

## Maintenance

### Cleaning the Cabinet

- Use a soft cloth slightly moistened with a mild detergent solution. Do not use a solution containing alcohol, spirits, ammonia or abrasives.

### Cleaning Discs

- When a disc becomes dirty, clean it with a cleaning cloth. Wipe the disc from the center out.
- Do not use solvents such as benzene, thinner, commercially available cleaners, or antistatic spray intended for analog records.



### Cleaning the CD lens

After prolonged usage, dirt or dust may accumulate at the CD lens. To ensure good playback quality, clean the CD lens with Philips CD Lens Cleaner or any commercially available. Follow the instructions supplied with the Lens Cleaner.

### Cleaning the Heads and the Tape Paths

- To ensure good recording and playback quality, clean the heads, the capstan(s), and pressure roller(s) after every 50 hours of tape operation.
- Use a cotton swab slightly moistened with cleaning fluid or alcohol.
- You can also clean the heads by playing a cleaning tape through once.

### Demagnetizing the heads

- Use a demagnetizing tape available at your dealer.

## Specifications

### AMPLIFIER

Output power	
FW306	
Music Power	2 x 15 W
FW325 / FW326	
Music Power	2 x 50 W
Signal-to-noise ratio	≥ 75 dBA (IEC)
Frequency response	60 - 16000 Hz
Input sensitivity	
Aux In	500 mV
Output	
Speakers (FW306)	≥ 3 Ω
Speakers (FW325/FW326)	≥ 6 Ω
Headphones	32 Ω - 1000 Ω
	(1) ± 1 dB

### CD PLAYER

Number of programmable tracks	20
Frequency range	40 - 20000 Hz
Signal-to-noise ratio	≥ 80 dBA
Channel separation	≥ 60 dB (1 kHz)
Total harmonic distortion	< 0.003%

### TUNER

FM wave range	87.5 - 108 MHz
MW wave range	531 - 1602 kHz
LW wave range	153 - 279 kHz
Tuning Grid	9 kHz
Number of presets	40
Antenna FM	75 Ω wire
AM	Loop antenna

### TAPE DECK

Frequency range	
Normal tape (type I)	80 - 12500 Hz (8 dB)
Signal-to-noise ratio	
Normal tape (type I)	≥ 48 dBA
Wow and flutter	≤ 0.4% JIS

### SPEAKERS (FW306)

System	Double port bass reflex
Impedance	3 Ω
Woofer	1 x 4"
Dimensions (w x h x d)	180 x 310 x 165 (mm)
Weight	1.84 kg each

### SPEAKERS (FW325/FW326)

System	2-way; Double port bass reflex
Impedance	6 Ω
Woofer	1 x 5.5"
Tweeter	2.5" Polydome
Dimensions (w x h x d)	210 x 310 x 220 (mm)
Weight	2.73 kg each

### GENERAL INFORMATION

Material/finish	Polystyrene
AC Power	220 - 230 V / 50 Hz
Power Consumption	
FW306	
Active	40 W
Standby	≤ 20 W
FW325/FW326	
Active	45 W
Standby	≤ 14 W
Dimensions (w x h x d)	265 x 310 x 330 (mm)
Weight (without speakers)	5.1 kg

Subject to modification

**Warning!** Under no circumstances should you try to repair the system yourself, as this will invalidate the warranty.

- If a fault occurs, check the points listed below before taking the system for repair.
- Should any problems persist after you have made these checks, consult your nearest dealer or service center.

## CD Player Operation

**"NO DISC" is displayed.**

- The disc is inserted upside down.  
→ *Place CD with printed side up.*
- Moisture condensation.  
→ *Wait until lens has adjusted to normal room temperature.*
- There is no disc in the CD tray.  
→ *Insert a CD.*
- The CD is dirty, badly scratched or warped.  
→ *Clean or replace the CD.*

## Radio Reception

**Poor radio reception**

- The signal strength is too weak.  
→ *Adjust the antenna.*
- The TV or VCR is too close to the stereo system.  
→ *Separate the stereo system from the TV or VCR.*
- *Connect an external antenna for better reception.*

## Tape Deck Operation

**"RECORDING ACTIVE" is displayed.**

- A recording is in progress.  
→ *Stop the recording or wait until it is finished.*

**"TAPE DUBBING ONLY" is displayed.**

- Tape dubbing is only possible in tape mode.  
→ *Switch source to tape mode.*

**Recording or playback cannot be made or there is a decrease in audio level.**

- *Dirty tape heads, capstans or pressure rollers.*  
→ *See section on tape deck maintenance.*
- Magnetic build-up in the record/playback head.  
→ *Use demagnetizing tape.*

## General

**System does not react when any button is pressed.**

- Electrostatic discharge.  
→ *Press STANDBY-ON to switch the system off. Remove the AC power plug from the wall outlet, then reconnect and switch on the system again.*

**No or poor sound.**

- Volume is not turned up.  
→ *Adjust VOLUME.*
- The headphones are connected.  
→ *Disconnect the headphones.*
- Speakers are not connected or are connected wrongly.  
→ *Check that the speakers are connected correctly.*  
→ *Make sure that the stripped speaker wire is clamped.*

**Reversed left and right sound.**

- Speakers are connected wrongly.  
→ *Check the speaker connections and location.*

**Lack of bass sound or apparently imprecise physical location of musical instruments.**

- Speakers are connected wrongly.  
→ *Check the speaker connection for proper phasing, red/black wires to red/black terminals.*

**Remote control has no effect on the system.**

- The distance to the system is too large.  
→ *Reduce the distance.*
- Batteries are inserted incorrectly.  
→ *Insert the batteries with their polarities (+/- signs) as indicated.*
- Batteries are exhausted.  
→ *Replace the batteries.*
- Wrong source is selected.  
→ *Select the source (CD, TUNER, etc.) before pressing the function button, (PLAY, PREV/NEXT, etc.).*

**Timer not working.**

- Timer is not switched on.  
→ *Press CLOCK • TIMER to switch on the timer.*
- Dubbing/recording is in progress.  
→ *Stop dubbing/recording.*

**System displays features automatically; buttons flash continuously.**

- Demonstration mode is switched on.  
→ *Press and hold STOP ■ for 3 seconds to switch off the demonstration.*



---





"Meet PHILIPS at the internet  
<http://www.philips.com>"

**FW 306**

**FW 325**

**FW 326**

