



VCD MP3-CD  
Mini Hi-Fi System



*Let's make things better.*



**PHILIPS**



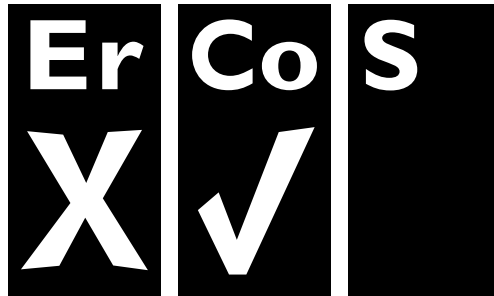

**Optimum disc playability :  
ensuring excellent picture quality**

Philips components and modules for the various CD applications have always enjoyed an excellent reputation in the market place for super disc playability - the ability to play discs which may be scratched, soiled or not fully according to the standard specification. This position has been underlined by tests showing the superior performance of the various Philips players, as well as by the positive experiences of millions of individual consumers around the world.

**Constantly improving performance**

As the penetration of the CD system has increased, and new applications like CD-ROM and Video CD have become commonplace, Philips Components - as the CD technology inventor and as one of the major suppliers of CD player modules in the industry - has constantly improved the performance of its products.

One of the ways in which this benefits users is by optimum disc playability. This is an important parameter for CD players other than CD Audio, and especially for the Video CD applications, because any loss of data from the disc will at best cause disturbances in the reproduced picture, and at worst can cause the player to lose track so that disc playing fails.

**Presenting Super Error Correction**

To ensure consistently good results when playing Video CD discs of all quality grades and conditions, Philips has introduced further improvements in the system's playability. These developments together are called Super Error Correction, a proprietary Philips technology optimizing the system's ability to handle less-than-perfect discs with the minimum disturbance to normal playing.

By effectively eliminating virtually all errors arising under normal playing conditions, Super Error Correction ensures that the picture quality as seen by the user is independent of disc play. The video encoding and processing during mastering of the disc, and the MPEG-1 decoding and video encoding in the signal processing stages, are now the only limiting factors for picture quality.

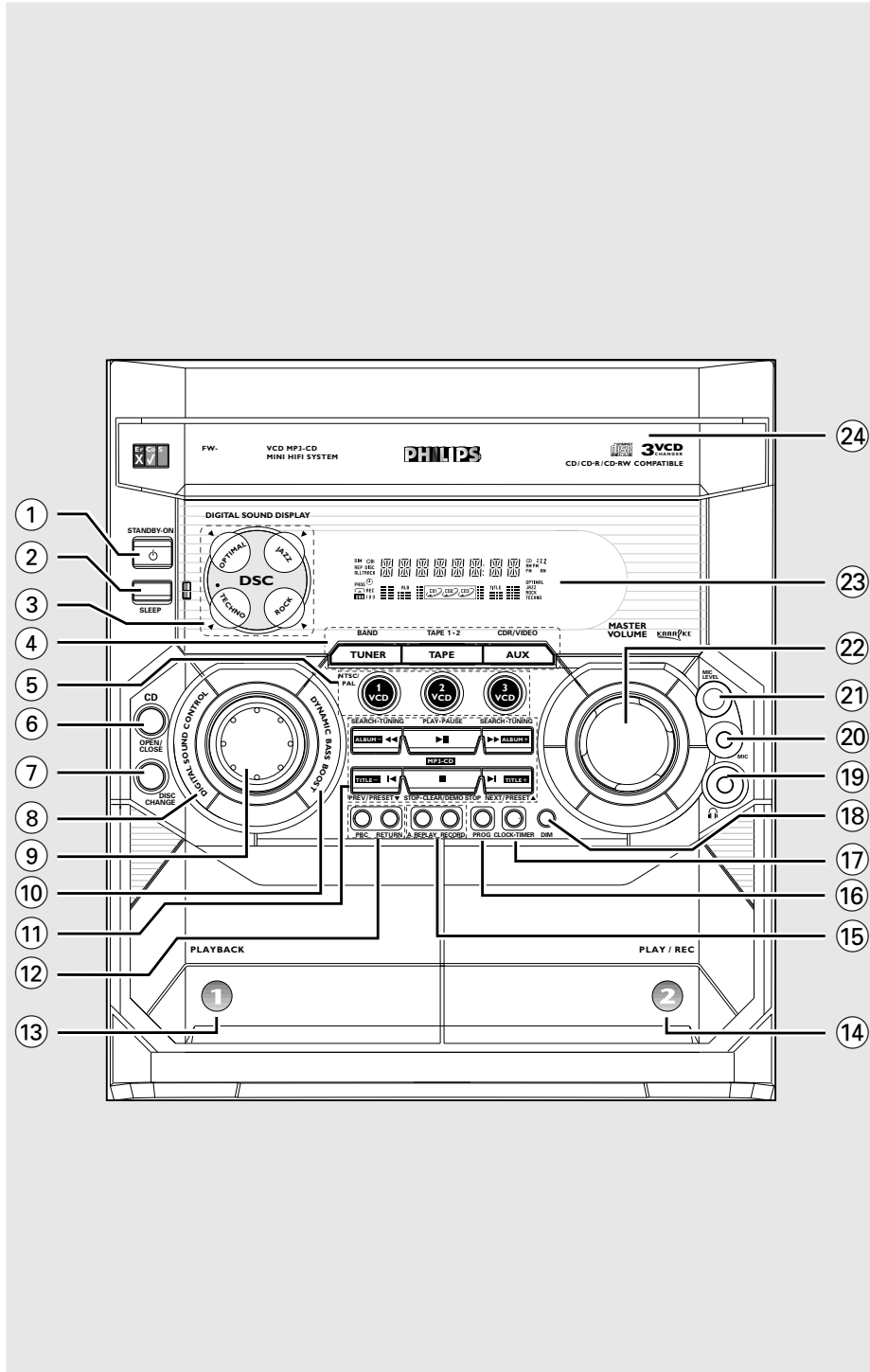

3



## DEMO MODE

To turn ON

Press & HOLD  button  
for 5 seconds

To turn OFF

Press & HOLD  button  
for 5 seconds

## PLUG & PLAY

1



Plug in the unit

2



Follow instructions  
in the display

3



Press "PLAY"

### CAUTION

*Use of controls or adjustments or performance of procedures other than herein may result in hazardous radiation exposure or other unsafe operation.*



# Index

English ..... 6

中文 ..... 35

Bahasa Melayu ..... 64

Bahasa Indonesia ..... 93

English

中文

Bahasa Melayu

Bahasa Indonesia





# Contents

## General Information

Supplied accessories .....	7
Environmental information .....	7
Safety information .....	7

## Preparations

Rear connections .....	8-9
Power	
Antennas connection	
Speakers connection	
Video Out Connection	
Connecting other equipment to your system	
Inserting batteries into the remote control .....	9

## Controls

Controls on the system and remote control .....	10-12
---	-------

## Basic Functions

Plug and Play .....	13
Demonstration mode .....	14
Switching the system on .....	14
Switching the system to standby mode .....	14
Dim mode .....	14
Volume control .....	14
Sound control .....	15
Digital Sound Control (DSC)	
Dynamic Bass Boost (DBB)	

## CD/VCD/MP3-CD Operations

Discs for playback .....	16
About MP3 disc .....	16-17
Loading discs .....	17
Playing discs .....	17
Replacing discs during playback .....	17
Selecting a desired track/passage .....	18
Selecting a desired Album/Title (MP3 disc only) .....	18
Repeat play .....	18
Programming the disc tracks .....	18-19
Erasing the programme .....	19

## VCD Operations

Adjusting the TV system .....	20
On screen display (OSD) .....	20
Playing a video CD with PBC functions .....	21
Returning to menu screen .....	21
Quick review .....	21
Playing a specific passage repeatedly .....	22
Resume playback from the last stop point .....	22
Picture effect .....	22
Slow	
Zoom	

Changing vocal .....	23
Adjusting the microphone echo .....	23
Adjusting the key tone .....	23

## Radio Reception

Tuning to radio stations .....	24
Storing preset radio stations .....	24-25
Automatic preset programming	
Manual preset programming	
Tuning to preset radio stations .....	25
Erasing a preset radio station .....	25
Changing tuning grid .....	25

## Tape Operation/Recording

Loading tape .....	26
Playing tapes .....	26
Rewinding/Fast forwarding .....	27
General information on recording .....	27
Preparation for recording .....	27
One touch recording / Recording the mixed sound .....	27
CD Synchronised start recording .....	27-28
Dubbing tapes .....	28

## Karaoke

Microphone mixing .....	28
-------------------------	----

## Clock/Timer

View clock .....	29
Clock setting .....	29
Timer setting .....	29-30
Deactivating the timer	
Activating the timer	
Sleep timer setting .....	30

## External sources

Listening to external sources .....	31
-------------------------------------	----

## Maintenance

.....	31
-------	----

## Specifications

.....	32
-------	----

## Troubleshooting

.....	33-34
-------	-------



## General Information

**IMPORTANT!**  
**PLEASE NOTE THAT THE VOLTAGE SELECTOR LOCATED AT THE REAR OF THIS SYSTEM IS PRESET AT 220V FROM THE FACTORY. FOR COUNTRIES THAT OPERATE AT 110V-127V, PLEASE ADJUST TO 110V-127V BEFORE YOU SWITCH ON THE SYSTEM.**

### Supplied accessories

- 2 speaker boxes
- remote control
- batteries (two AA size) for remote control
- AM loop antenna
- FM wire antenna
- One Video cinch cable

### Environmental information

All unnecessary packaging has been omitted. We have tried to make the packaging easy to separate into three materials: cardboard (box), polystyrene foam (buffer) and polyethylene (bags, protective foam sheet).

Your system consists of materials which can be recycled and reused if disassembled by a specialised company. Please observe the local regulations regarding the disposal of packaging materials, exhausted batteries and old equipment.

### Safety information

- Before operating the system, check that the operating voltage indicated on the typeplate (or the voltage indication beside the voltage selector) of your system is identical with the voltage of your local power supply. If not, please consult your dealer.
- Place the system on a flat, hard and stable surface.
- Place the system in a location with adequate ventilation to prevent internal heat build-up in your system. Allow at least 10 cm (4 inches) clearance from the rear and the top of the unit and 5 cm (2 inches) from each side.
- Do not expose the system, batteries or discs to excessive moisture, rain, sand or heat sources caused by heating equipment or direct sunlight.
- The lens may cloud over when the system is suddenly moved from cold to warm surroundings, making it impossible to play a disc. Leave the system in the warm environment until the moisture evaporates.
- The mechanical parts of the set contain self-lubricating bearings and must not be oiled or lubricated.
- **When the system is switched to Standby mode, it is still consuming some power. To disconnect the system from the power supply completely, remove the AC power plug from the wall socket.**



## Preparations

English

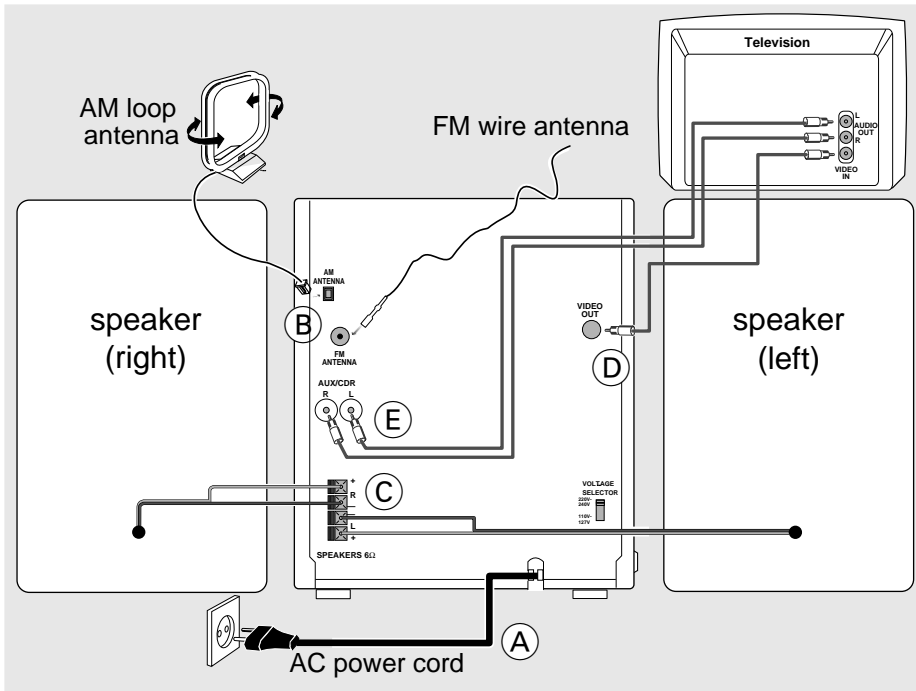

### Rear connections

The type plate is located at the rear of the system.

#### A Power

- Before connecting the AC power cord to the wall outlet, ensure that the following are done;
- If your system is equipped with a Voltage Selector; set the VOLTAGE SELECTOR to the local power line voltage.
  - All other connections have been made.



#### WARNING!

- For optimal performance, use only the original power cable.
- Never make or change any connections with the power switched on.

#### B Antennas Connection

Connect the supplied AM loop antenna and FM antenna to the respective terminals. Adjust the position of the antenna for optimal reception.

##### AM Antenna

- Position the antenna as far as possible from a TV, VCR or other radiation source.

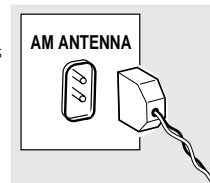

##### FM Antenna

- For better FM stereo reception, connect an outdoor FM antenna to the FM ANTENNA terminal.

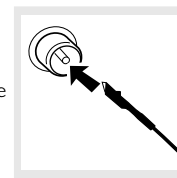





## Preparations

### C Speakers Connection

#### Front Speakers

Connect the speaker wires to the SPEAKERS terminals, right speaker to "R" and left speaker to "L", coloured (marked) wire to "+" and black (unmarked) wire to "-".

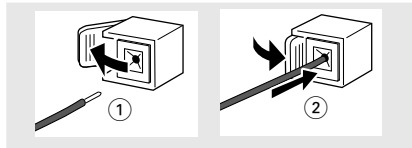

- Fully insert the stripped portion of the speaker wire into the terminal as shown.

#### Notes:

- For optimal sound performance, use the supplied speakers.
- Do not connect more than one speaker to any one pair of + / - speaker terminals.
- Do not connect speakers with an impedance lower than the speakers supplied. Please refer to the SPECIFICATIONS section of this manual.

### D Video Out Connection

Connect the VIDEO OUT terminal at the rear of the system to the TV or VCR VIDEO IN for viewing or recording.

#### Note:

- To avoid magnetic interference with the picture on your TV, do not position the front speakers too close to the TV.

### E Connecting other equipment to your system

Use a cinch cable to connect **AUX/CDR IN** to the analogue audio out terminals of an external equipment (TV, VCR, Laser Disc player, DVD player or CD Recorder).

#### Note:

- If you are connecting equipment with a mono output (a single audio out terminal), connect it to the AUX/CDR IN left terminal. Alternatively, you can use a "single to double" cinch cable (the output sound still remain mono).

### Inserting batteries into the remote control

Insert two batteries type R06 or AA into the remote control with the correct polarity as indicated by the "+" and "-" symbols inside the battery compartment.

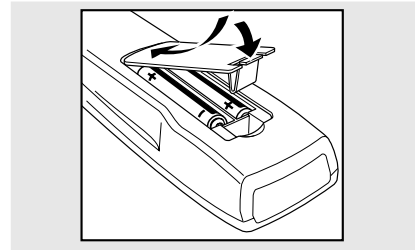

#### CAUTION!

- Remove batteries if they are exhausted or will not be used for a long time.
- Do not use old and new or different types of batteries in combination.
- Batteries contain chemical substances, so they should be disposed off properly.



## Controls (main system's illustrations on page 3)

### Controls on the system and remote control

- ① **STANDBY ON**
- to switch the system on or to standby mode.
- ② **SLEEP**
- to activate/deactivate or set the sleep timer.
- ③ **DIGITAL SOUND DISPLAY**
- the active DSC will be lighted.
- ④ **TUNER (BAND)**
- to select waveband : FM or MW.
- TAPE (TAPE 1•2)**
- to select tape deck 1 or 2.
- AUX (CDR/VIDEO)**
- to select the input for an additional appliance.
- ⑤ **VCD 1 / 2 / 3**  
**(VCD.CD 1/2/3 - MP3.CD 1/2/3)**
- to select disc tray 1, 2 or 3.
- VCD 1 (NTSC/PAL)**
- (on the system only) to select corresponding video output for NTSC or PAL system of your TV set (except Multi-system TV).
- ⑥ **OPEN/CLOSE**
- to open or close the disc tray.
- ⑦ **DISC CHANGE**
- to change disc(s).
- ⑧ **DIGITAL SOUND CONTROL (DSC)**
- to activate the jog control for DSC selection.
- ⑨ **Jog control**
- to select the desired sound effect for the selected sound feature.
- DSC** ..... JAZZ, ROCK, TECHNO or OPTIMAL.
- DBB** ..... DBB 1, DBB 2, DBB 3 or DBB OFF.
- ⑩ **DYNAMIC BASS BOOST (DBB)**
- to activate the jog control for DBB selection.

### ⑪ Mode Selection

#### PLAY•PAUSE

for CD/VCD/MP3-CD...to start or interrupt playback.

for Tape ..... to start playback.

for Plug & Play...(on the system only) to initiate and start plug & play mode.

#### SEARCH•TUNING (ALBUM ) SEARCH•TUNING (ALBUM )

for MP3-CD ..... to select previous/next album.

for VCD ..... to move the zoomed picture to the left or right.

for CD/VCD .... to search backward/forward.

for Tuner ..... to tune to a lower or higher radio frequency.

for Tape ..... to rewind or fast forward.

for Clock ..... (on the system only) to set the hour.

#### STOP•CLEAR / DEMO STOP

for CD/VCD/MP3-CD...to stop playback or to clear a programme.

for Tuner ..... (on the system only) to stop programming or to erase a selected preset.

for Tape ..... to stop playback or recording.

for Demo ..... (on the system only) to activate/deactivate the demonstration.

for Clock ..... (on the system only) to exit clock setting or cancel timer.

for Plug & Play...(on the system only) to exit plug & play mode.

#### PREV / PRESET (TITLE )

#### NEXT / PRESET (TITLE )

for MP3-CD ..... to select previous/next title.

for VCD ..... to move the zoomed picture down or up.

..... to select next or previous menu or track during playback (for VCD with PBC switched on).

for CD/VCD .... to skip to the beginning of the current, previous, or next track.

for Tuner ..... to select a preset radio station.

for Clock ..... (on the system only) to set the minute.



## Controls

English

### ⑫ VCD operations (for VCD version 2.0 only)

#### PBC

- to switch on or off the playback control mode.

#### RETURN

- to return to the previous menu level during playback (for VCD with PBC switched on).

### ⑬ Tape deck 1

### ⑭ Tape deck 2

### ⑮ Tape deck operations

#### A. REPLAY

- to select continuous playback in either AUTO REPLAY or ONCE mode only.

#### RECORD

- to start recording on tape deck 2.

### ⑯ PROG

for CD/VCD/MP3-CD...to programme disc tracks.

for Tuner ..... to programme preset radio stations.

for Clock ..... to select 12- or 24-hour clock mode.

### ⑰ CLOCK•TIMER

- to view the clock, set the clock or set the timer.

### ⑱ DIM

- to select different brightness for the display screen : DIM 1, DIM 2, DIM 3 or DIM OFF.

### ⑲

- to connect headphones.

### ⑳ MIC

- to connect microphone jack.

### ㉑ MIC LEVEL

- to adjust the mixing level for karaoke or microphone recording.

### ㉒ MASTERVOLUME (VOLUME +/–)

- to increase or decrease the volume.

### ㉓ Display screen

- to view the current status of the system.

### ㉔ Disc tray

### ㉕ VCD operations (on remote control only)

#### OSD

- to switch on or off the On Screen Display on the TV.

#### ZOOM

- to enlarge a still picture of the VCD on the TV screen.

#### RESUME

- to continue playback again from where you have stopped (for VCD with PBC switched off).

#### VOCAL

- to fade out the original vocal from a Karaoke VCD or to switch between mono or stereo mode during audio disc playback.

#### KEY CONTROL (b k # )

- to change the VCD key tone level to suit your vocal range.

b ..... to decrease the key tone level.

k ..... to restore the key tone level to original setting.

# ..... to increase the key tone level.

#### ECHO –/+

- to adjust the VCD echo level for karaoke after inserted the microphone.

#### SLOW

- to watch the VCD at a slower speed.

#### A - B

- to playback a certain scene or passage of a CD/ VCD repeatedly.

#### DIGEST

- to scan through a VCD or a specific track.

### ㉖ IS (not functional for this model)



## Controls

- ⑲ REPEAT
  - to playback track/disc/programme repeatedly.
- ⑳ Numeric keys (0 – 9)
  - (numbers consisting more than two figures must be keyed in within 2 seconds.)
  - to direct key in a track number for CD/VCD/MP3-CD.
- ㉑
  - to switch the system to standby mode.

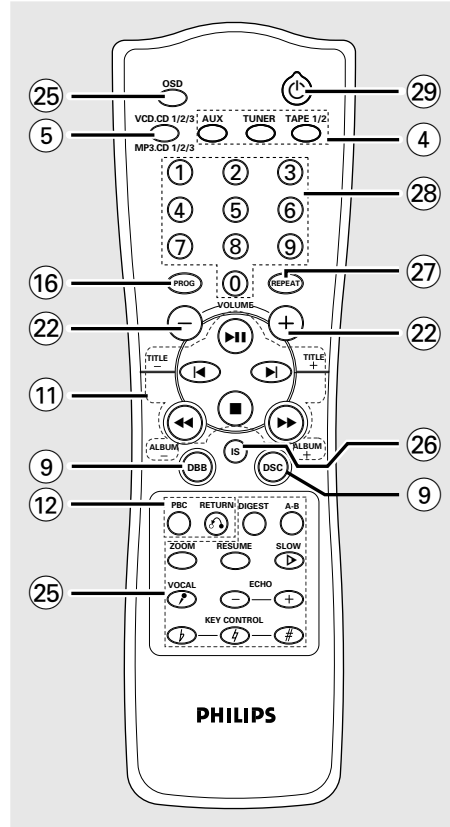

- Notes for remote control:**
- First select the source you wish to control by pressing one of the source select keys on the remote control (for example TAPE 1/2, TUNER).
  - Then select the desired function (for example ►, ◀, ▶).



## Basic Functions

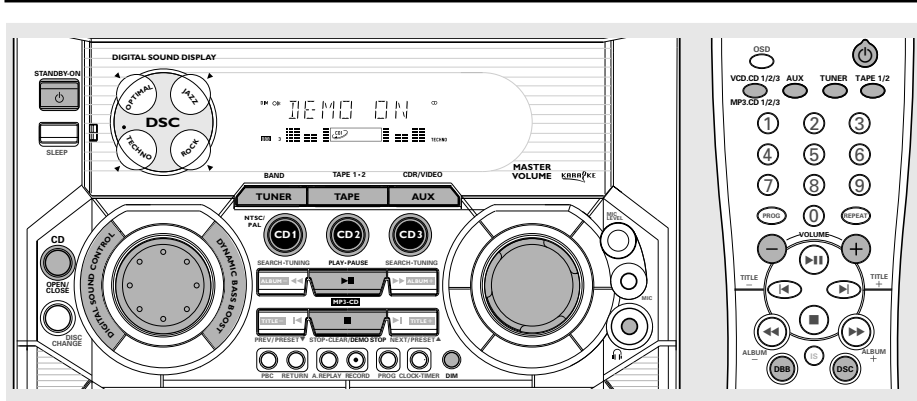

English

**IMPORTANT!**  
Before operating the system, complete the preparation procedures.

### Plug and Play

Plug and Play allows you to store all available radio stations automatically.

#### First time setup/power up

- 1 When you turn on the main supply, "AUTO INSTALL - PRESS PLAY" is displayed.
- 2 Press **▶||** on the system to start installation.
  - "INSTALL" is displayed, followed by "TUNER" and "AUTO".
  - **PROG** starts flashing.
  - All available radio stations with sufficient signal strength will be stored automatically, starting from FM and followed by MW band.
  - When all the available radio stations are stored or the memory for 40 presets are used, the last preset radio station will be played.

#### To reinstall Plug and Play

- 1 In standby or demonstration mode, press and hold **▶||** on the system until "AUTO INSTALL - PRESS PLAY" is displayed.
- 2 Press **▶||** again to start installation.
  - All previously stored radio stations will be replaced.

- To exit without storing the Plug and Play**
- Press **■** on the system.
    - If you do not complete the Plug and Play installation, the function will be restarted when you next turn on the main supply again.

#### Notes:

- When the power is turned on, the disc tray may open and close to initialise the system.
- If no stereo frequency is detected during Plug and Play, "CHECK ANTENNA" will be displayed.
- During Plug and Play, if no button is pressed within 15 seconds, the system will exit Plug and Play mode.





## Basic Functions

### Demonstration mode

The system has a demonstration mode that shows the various features offered by the system.

#### To activate the demonstration

- In standby mode, press and hold **■** on the system until "WELCOME" is displayed.  
→ The demonstration will begin.

#### To deactivate the demonstration

- Press and hold **■** on the system until "DEMO OFF" is displayed.  
→ The system will switch to standby mode.

#### Note:

– If you have not deactivated the demonstration, it will resume five seconds after the system switches to standby mode.

### Switching the system on

#### In standby/demonstration mode

- Press **STANDBY ON** to switch on the last selected source.
- Press **VCD 1/2/3 (VCD.CD 1/2/3)**, **TUNER**, **TAPE (TAPE 1/2)** or **AUX**.
- Press **OPEN/CLOSE**.  
→ The system will switch to CD mode.

### Switching the system to standby mode

#### In demonstration mode

- Press and hold **■** on the system.

#### In any other source mode

- Press **STANDBY ON** (or **⏻** on the remote control).  
→ The clock will appear on the display when the system is in standby mode.

### Dim mode

You can select the desired brightness for the display.

- In any source mode (except standby mode), press **DIM** repeatedly to select : DIM 1, DIM 2, DIM 3 or DIM OFF display mode.  
→ **DIM** is shown, except for DIM OFF mode.

DIM mode	Brightness	Spectrum Analyser
<b>1</b>	normal	off
<b>2</b>	half	on
<b>3</b>	half	off
<b>OFF</b>	normal	on

#### Note:

– In standby mode, pressing DIM to select half or full brightness for clock display.

### Volume control

Adjust **MASTERVOLUME** (or press **VOLUME +** or **–** on the remote control) to increase or decrease the volume level.

#### To listen through the headphones

- Connect the headphones plug to the  socket at the front of the system.  
→ The speakers will be muted.





## Basic Functions

### Sound control

#### Digital Sound Control (DSC)

The DSC feature enables you to enjoy special sound effects that have preset equaliser settings, providing the best music reproduction.

- 1 Press **DSC**.  
→ The selected DSC is shown.
- 2 Adjust the jog control (or press **DSC** on the remote control repeatedly) to select : JAZZ, ROCK, TECHNO or OPTIMAL.

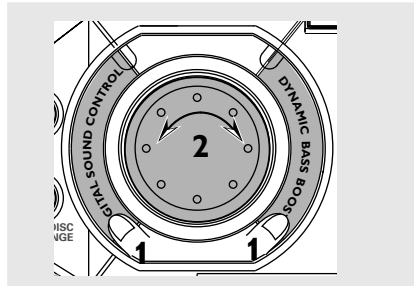

#### Automatic DSC-DBB selection

The best DBB setting is generated automatically for each DSC selection. You can manually select the DBB setting that best suits your listening environment.

DSC	DBB
JAZZ	off
ROCK	on (3)
TECHNO	on (3)
OPTIMAL	on (2)

English

### Dynamic Bass Boost (DBB)

There are three DBB settings to enhance the bass response.

- 1 Press **DBB**.  
→ The selected **DBB** is shown, except for DBB OFF mode.
- 2 Adjust the jog control (or press **DBB** on the remote control repeatedly) to select : DBB 1, DBB 2, DBB 3 or DBB OFF.

#### Note:

– Some discs or tapes might be recorded in high modulation, which causes a distortion at high volume. If this occurs, switch off DBB or reduce the volume.



1

English

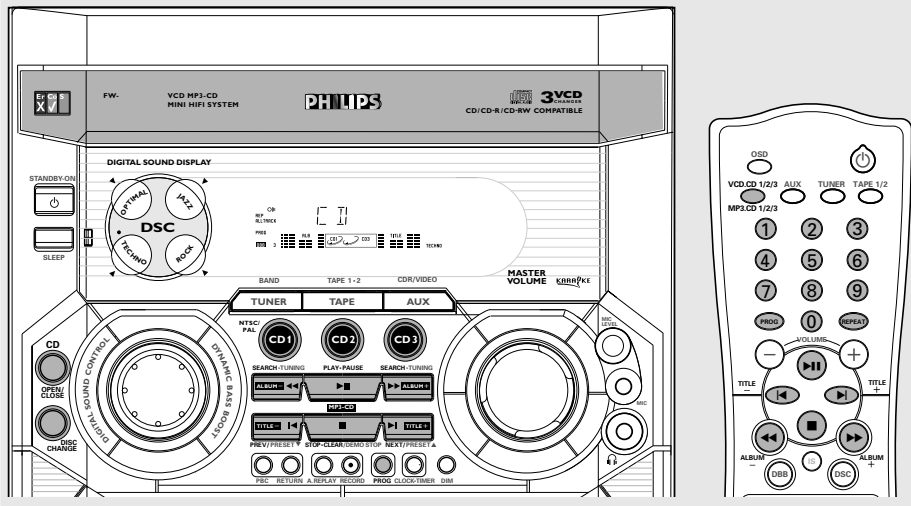

**IMPORTANT!**

- This system is designed for regular discs. Therefore, do not use any accessories such as disc stabiliser rings or disc treatment sheets, etc., as offered on the market, because they may jam the changer mechanism.
- Do not load more than one disc into each tray.

Before viewing the Video CD, ensure that the set is switched to corresponding PAL or NTSC system of your TV set (exception Multi-system TV).

**Discs for playback**

This system is able to play :

- All pre-recorded audio CDs
- All finalised audio CDR and audio CDRW discs
- All pre-recorded video CDs
- MP3-CDs (CD-ROMs with MP3 tracks)  
Make sure filename ends with .mp3



**About MP3 disc**

**Supported formats**

- ISO9660, Joliet, Multisession
- Max. track number plus album is 255
- Max. nested directory is 8 levels
- The max. album number is 32
- The max. MP3 programme track number is 99
- Supported VBR bit-rate
- Supported sampling frequencies for MP3 disc are: 32 kHz, 44.1 kHz, 48 kHz
- Supported Bit-rates of MP3 disc are: 32, 64, 96, 128, 192, 256 (kbps)

**Making your own MP3-CD**

- 1 Rip the music from your own Digital Audio CDs or download legal MP3 music from the Internet.
- 2 Record ("burn") the music on CD-R(W) disc with your home PC. Make sure to use a recording speed not faster than indicated on the CD-R(W) and avoid running other programmes simultaneously on your PC during the recording process.





## CD/VCD/MP3-CD Operations

### Sound Quality

Take note that MP3-CD compilations should best contain only MP3 tracks (.mp3). **To achieve a good MP3 quality, a bit rate of 128 kbps is recommended.**

### Loading discs

- 1 Press **OPEN/CLOSE** to open the disc tray.
- 2 Load up to two discs on the individual disc trays. To load the third disc, press **DISC CHANGE**.  
→ The disc tray will rotate until the empty tray is ready for loading.

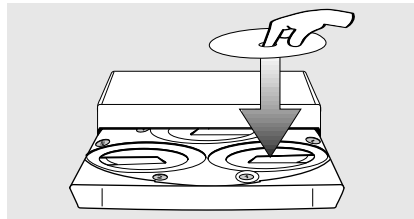

- 3 Press **OPEN/CLOSE** to close the disc tray.  
→ "READING" is displayed. The selected disc tray, total number of tracks and the playing time will appear on the display.  
→ For MP3 disc, the name of the first album and title will be scrolled through the display once and followed by "XXXX XXXX".

#### Notes:

- Load the discs with the label side facing up.
- For MP3 disc, the disc reading time may exceed 10 seconds due to the large number of songs compiled into one disc.

### Playing discs

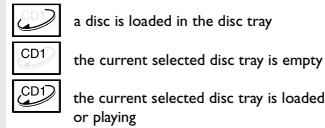

#### To play all discs on the disc tray

- Press **▶||**.  
→ All the available discs will play once, then stop.  
→ During playback, the selected disc tray, track number and elapsed playing time of the current track are displayed.  
→ For MP3 disc, **TITLE** is shown. For mixed mode discs, only one mode will be selected for playback depending on the recording format.

#### To play the selected disc only

- In CD mode, press **VCD 1**, **VCD 2** or **VCD 3** on the system.  
→ The selected disc will play once, then stop.

#### To interrupt playback

- Press **▶||**.  
→ The current track time flashes.
- To resume playback, press **▶||** again.

#### To stop playback

- Press **■**.

### Replacing discs during playback

- 1 Press **DISC CHANGE**.  
→ The disc tray will open without interrupting current playback.
- 2 To change the inner disc, press **DISC CHANGE** again.  
→ "DISC CHANGE" is displayed and the disc will stop playing.  
→ The disc tray will close to retrieve the inner disc, then reopen with the inner disc accessible.



## CD/VCD/MP3-CD Operations

### Selecting a desired track/passage

#### To search for a particular passage during playback

- Press ◀◀ or ▶▶ to select four different search speed.
  - "FRX1" ; "FRX2" ; "FRX3" or "FRX4" is displayed on the TV screen when you select a fast rewind search.
  - "FFX1" ; "FFX2" ; "FFX3" or "FFX4" is displayed on the TV screen when you select a fast forward search.
  - Normal playback will begin at the end of the fast rewinding or forwarding of the selected track.
- Play returns to normal when ▶|| is pressed or when a new track is selected.

#### To select a desired track

- Press ◀ or ▶ (or **numeric keys 0-9** on the remote control) repeatedly until the desired track is displayed.
- If playback is stopped, press ▶|| to start playback.

#### Note:

– Maximum track selection from digital keys on the remote control is 199 for MP3-CD and 99 for VCD/CD.

### Selecting a desired Album/Title (MP3 disc only)

#### To select a desired album

- Press **ALBUM** -/+ (◀◀ or ▶▶) repeatedly.
  - **ALB** starts flashing and the album's name will scroll through the display once.

#### To select a desired title

- Press **TITLE** -/+ repeatedly (◀◀/▶▶ or **numeric keys 0-9** on the remote control).
  - **TITLE** starts flashing and the title's name will scroll through the display once.

### Repeat play

You can select and change the various play modes before or during playback.

- 1 Press **REPEAT** on the remote control repeatedly to select :
  - "TRACK" – to repeat playback of the current track.
  - "DISC" – to repeat playback of the current disc.
  - "PROGRAM" – to repeat playback of the programmed tracks.
- 2 To resume normal playback, press **REPEAT** until "REPEAT OFF" is displayed.
  - **REP** is shown, except for REPEAT OFF mode.

#### Notes:

- During programme play mode, it is not possible to repeat playback the current disc (Repeat Disc mode).
- Pressing the ■ button will cancel all repeat modes.



## CD/VCD/MP3-CD Operations

### Programming the disc tracks

Programming tracks is possible when playback is stopped. Up to 99 tracks can be stored in the memory in any order.

- 1 Load the desired discs on the disc tray (refer to "Loading discs").
- 2 Press **VCD 1/2/3** to select a disc.  
→ Programming can only be done on the selected disc.
- 3 Press **PROG** to start programming.  
→ **PROG** starts flashing.
- 4 Press **◀** or **▶** (or **numeric keys 0-9** on the remote control) repeatedly to select the desired track.
  - For **MP3 disc**, press **ALBUM** **- / +** and **TITLE** **- / +** to select the desired album and title for programming.
- 5 Press **PROG** to store the track.
  - Repeat **steps 3-5** to store other discs and tracks.
- 6 To end programming, press **■ once**.  
→ **PROG** stays and the programme mode remains active.  
→ The total number of tracks programmed and the total playing time are displayed.  
→ For **MP3 disc**, total playing time will not be shown.
- 7 To start programme play, press **▶||**  
→ "PLAY PROGRAM" is displayed.

#### Notes:

- To programme from a video CD, the PBC mode has to be switched off.
- It is not possible to create a programme with MP3 tracks from multiple CDs, or combined with normal audio tracks.
- If the total playing time is more than "99:59" then "- : - : -" is displayed instead of the total playing time.
- If you attempt to programme more than 99 tracks, "FULL" is displayed.
- During programming, if no button is pressed within 20 seconds, the system will exit the programme mode automatically.

### To review the programme

- Stop playback and press **◀** or **▶** repeatedly.
- To exit review mode, press **■**.

### Erasing the programme

- Press **■ once** when playback is stopped or **twice** during playback.  
→ **PROG** disappears and "PROGRAM CLEAR" is displayed.

#### Note:

- The programme will be erased when the system is disconnected from the power supply or when the disc tray is opened.

**For Recording, please refer to "Tape Operation/Recording".**



## VCD Operations

English

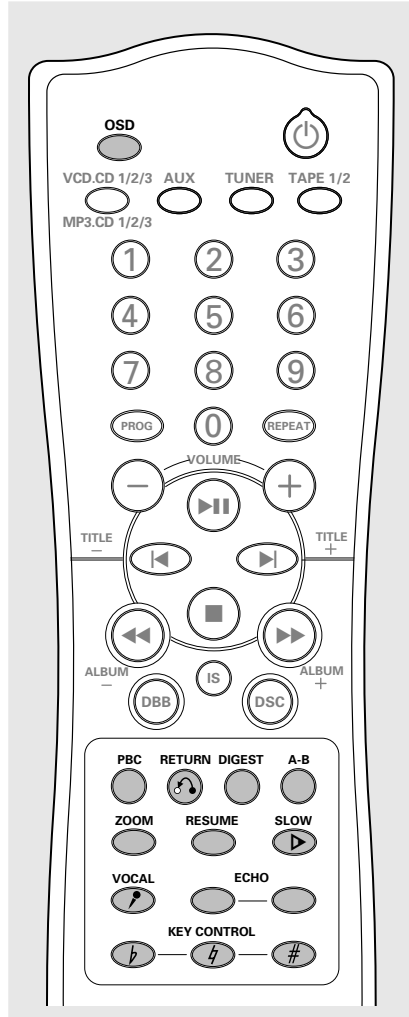

### Adjusting the TV system

Before viewing the video CD, ensure that the mini system is switched to corresponding PAL or NTSC system of your TV set (except Multi-system TV).

- 1 In CD/VCD mode, press and hold **VCD 1** for more than **three seconds**.
- 2 Press and hold **VCD 1** again to switch between PAL or NTSC.  
→ The setting will remain after it has been set.

**Note:**

- Before adjusting the TV system, make sure that there is no MP3-CD in disc tray 1 during power up.

### On screen display (OSD)

If you are playing a video CD, your TV screen will be able to display the messages of the current operating status (for example, PLAY, STOP) and the information stored in the disc.

- Press **OSD** on the remote control repeatedly to switch on or off the On Screen Display mode.

When OSD is switched on, you can see the following display on the TV screen.

PLAY XX/TT MM:SS

- "XX" is the current track.
- "TT" is the total tracks.
- "MM" is in minutes.
- "SS" is in seconds.

**Note:**

- You can also view the information from a MP3-CD or normal CD.



## VCD Operations

### Playing a video CD with PBC functions *(for VCD version 2.0 only)*

VCD with PBC (Playback Control) will be indicated on the display of the set as soon as they are inserted. PBC is a predefined play sequence stored in the VCD.

- 1 Switch on the TV, insert a VCD with PBC and press **▶** to start playback.
- 2 **MENU** appears on the TV screen.

#### If the menu consists of a list of tracks, you can select a track directly

- Press **numeric keys 0-9** on the remote control to select your choice.  
→ The VCD starts playing of the selected sequence automatically.

#### Note:

- If a menu consists of more than one page, press **◀/▶** to go through the pages.

### Switching off PBC

- In stop mode, press **PBC**.  
→ "PBC OFF" is displayed on TV screen.

#### Notes:

- When PBC mode is switched on, it is not possible to programme the disc track.
- The menu structure depends on the information stored in the VCD. Please refer to the information supplied with the disc.

### Returning to menu screen

- Press **RETURN** to return to the previous VCD disc menu level. **PBC mode must be switched on.**

### Quick review

This feature allows you to scan through a VCD for a quick review. **PBC mode must be switched off.** There are four digest modes for selection.

- 1 Press **DIGEST** on the remote control.  
→ "DIGEST" is displayed.  
→ "1.INTRO SCAN", "2.DIGEST DISC", "3.DIGEST TRACK" and "4.EXIT DIGEST MENU" appear on TV screen.

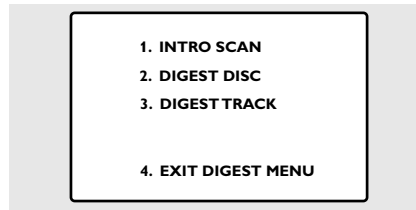

- Press **digit ①** on the remote control to select "INTRO SCAN".  
→ The first 10 seconds of each track is played.
  - Press **digit ②** on the remote control to select "DIGEST DISC".  
→ The first frame of each track appears on the TV screen.  
→ Press **digit 0 - 9** on the remote control to playback the desired tracks.  
→ Press **◀** or **▶** to view the previous or next page for additional information.
  - Press **digit ③** on the remote control to select "DIGEST TRACK".  
→ The first track of the selected disc will be divided into 9 sessions and displayed on the TV screen.  
→ Press **digit 0 - 9** on the remote control to playback the desired session.  
→ Press **◀** or **▶** to digest the next track.
- 2 To exit Digest mode, press **digit ④** on the remote control to select "EXIT DIGEST MENU".





## VCD Operations

### Playing a specific passage repeatedly

This feature is also applicable to audio CD (except for MP3-CD). To play a certain scene or passage of the disc repeatedly.

- 1 Press **A-B** on the remote control during playback to mark the start of the chosen scene or passage.  
→ "SET A" is displayed
- 2 Press **A-B** again to mark the end of the chosen scene or passage.  
→ "SET B" is displayed
- The selected scene or passage is played repeatedly.  
→ "PLAY A-B" is displayed
- 3 Press **A-B** once more to return to normal playback.  
→ "CLEAR A-B" is displayed

#### Notes:

- You can also cancel A-B Repeat by pressing **⏪** or **⏩**.
- You are able to set the A-B marking within the same track only. Once it crosses from one track to the next, the A-B marking is reset.

### Resume playback from the last stop point

This feature is also applicable to audio CD (except for MP3-CD).

- In stop mode, press **RESUME** on the remote control to start playback again from where you have stopped.

#### Note:

- Resume information is lost if you have changed the disc, opened the disc tray, change source or disconnected the system from the power supply.
- Resume is not available when PBC mode is switched on.

### Picture effect

#### Slow

- 1 Press **SLOW** on the remote control to watch a VCD at a slower speed. There are three types of slow modes to select.  
→ The sound is muted.  
→ On TV screen, "SLOW 1", "SLOW 2" or "SLOW 3" is displayed.
- 2 To resume playback at normal speed, press **▶||**

#### Zoom

This feature enables you to view a still picture frame in an enlarge mode.

- 1 During playback, press **▶||** to have a still picture on the TV screen.  
→ The sound is muted.  
→ On TV screen, "PAUSE" is displayed.
- 2 Press **ZOOM** on the remote control once to enlarge the still picture by two times.  
→ On TV screen, "ZOOM" is displayed.
- You can move the zoomed picture left or right by pressing **◀◀** or **▶▶** respectively.
- You can move the zoomed picture down or up by pressing **⏪** or **⏩** respectively.
- 3 Press **ZOOM** once more to return to normal still frame.
- 4 Press **▶||** to continue playback.



## VCD Operations

### Changing vocal

This feature allows you to fade out the original vocal from a karaoke VCD. You can also use it to select the desired language.

- Press **VOCAL** on the remote control repeatedly to select the following modes :  
→ STEREO → STEREO VOCAL LEFT → STEREO VOCAL RIGHT → MONO LEFT → MONO RIGHT → STEREO ...

#### STEREO

- same effect as the original recorded disc.

#### STEREO VOCAL LEFT/RIGHT

- fade out the original vocal for special recorded Karaoke disc only (**ECHO mode must be switched on**).

#### MONO LEFT/RIGHT

- select the language on a bilingual VCD.

### Adjusting the key tone

This feature allows you to change the key tone of your vocal range.

- Press **b** on the remote control to decrease vocal key level.  
→ "KEY -x" is displayed.
- Press **#** on the remote control to increase vocal key level.  
→ "KEY +x" is displayed.
- Press **h** on the remote control to restore vocal key to original setting.  
→ "KEY FLAT" is displayed.

#### Note:

- "x" denotes the key level.

### Adjusting the microphone echo

This feature allows you to add echo while singing or talking through a microphone.

- Press **ECHO - / +** on the remote control to decrease, increase or switch off the echo effect.  
→ "ECHO -x", "ECHO +x" or "ECHO OFF" is displayed.

#### Notes:

- "x" denotes the echo level.
- You are advised to switch off the echo effect when not using the feature.
- If microphone is not inserted, "INSERT MIC" is displayed.
- Echo will switch off automatically when unplug the microphone from the system.



## Radio Reception

English

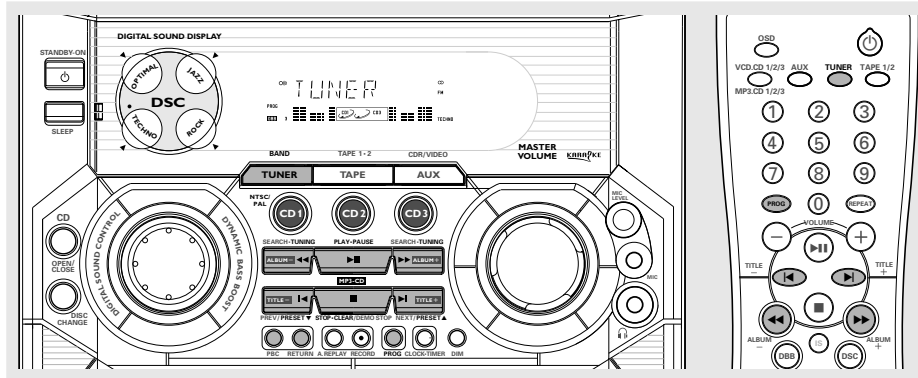

### Tuning to radio stations

- 1 Press **TUNER** to select TUNER mode.  
→ "TUNER" is displayed. A few seconds later, the current radio frequency will appear on the display.  
→ If an FM station is received in stereo, is displayed.
  - 2 Press **TUNER** again to select the desired waveband : FM or MW.
  - 3 Press and hold **◀** or **▶** until the frequency indication starts to change, then release.  
→ The display will show "SEARCH" until a radio station with sufficient signal strength is found.
  - 4 Repeat step 3 if necessary until you find the desired radio station.
- To tune to a weak station, press **◀** or **▶** briefly and repeatedly until optimal reception found.

### Storing preset radio stations

You can store up to 40 preset radio stations in the memory.

#### Automatic Preset Programming

- Plug and Play setting (refer to "Basic Functions - Plug and Play").  
OR
- 1 Press **TUNER** to select TUNER mode.  
**To begin automatic preset from a desired preset number**
    - Press **◀** or **▶** to select the desired preset number.  
→ If a radio station has been stored in one of the presets, it will not be stored again under another preset number.
  - 2 Press and hold **PROG** until "AUTO" is displayed.  
→ **PROG** starts flashing.  
→ All available radio stations with sufficient signal strength will be stored automatically, starting from FM and followed by MW band.  
→ When all the available radio stations are stored or the memory for 40 presets are used, the last preset radio station will be played.
- To stop storing the automatic preset**
- Press **PROG** or **■** on the system.





## Radio Reception

**Note:**

– If no preset number is selected, automatic preset will begin from preset (1) and all your former presets will be overridden.

### Manual Preset Programming

- 1 Tune to your desired radio station (refer to "Tuning to radio stations").
- 2 Press **PROG**.
  - **PROG** starts flashing.
  - The next available preset number is displayed for selection.

#### To store the radio station to another preset number

- Press **◀** or **▶** to select the desired preset number.
- 3 Press **PROG** again to store the radio station.
  - **PROG** disappears.
- Repeat **steps 1–3** to store other radio stations.

#### To exit manual preset mode

- Press **■** on the system.

**Notes:**

– If you attempt to store more than 40 preset radio stations, "FULL" is displayed.

– During programming, if no key is pressed within 20 seconds, the system will exit the programme mode automatically.

### Tuning to preset radio stations

- Once you've programmed the radio stations, press **◀** or **▶** to select the desired preset number.
  - The preset number, radio frequency, and waveband are displayed.

### Erasing a preset radio station

- 1 Press **◀** or **▶** to select the preset radio station to be erased.
- 2 Press and hold **■** on the system until "PRESET DELETED" is displayed.
  - The deleted radio frequency remains on the display.
  - The preset numbers of all other preset radio stations in the band with higher numbers are also decreased by one.
- Repeat **steps 1–2** to erase other preset radio stations.

### Changing tuning grid *(not available for all versions)*

In North and South America, the frequency step between adjacent channels in the MW band is 10 kHz (9 kHz in some areas). The preset frequency step in the factory is 9 kHz.

#### Changing the tuning grid will erase all previously stored preset radio stations.

- 1 Disconnect the system from the AC power supply (pull out the AC power cord).
- 2 While holding down **TUNER** and **▶▶** on the system, reconnect the system to the AC power supply.
  - The display will show "GRID 9" or "GRID 10".

**Notes:**

– GRID 9 and GRID 10 indicate that the tuning grid is in step of 9 kHz and 10 kHz respectively.

– The FM tuning grid also will be changed from 50 kHz to 100 kHz or vice versa.

**For Recording, please refer to "Tape Operation/Recording".**



## Tape Operation / Recording

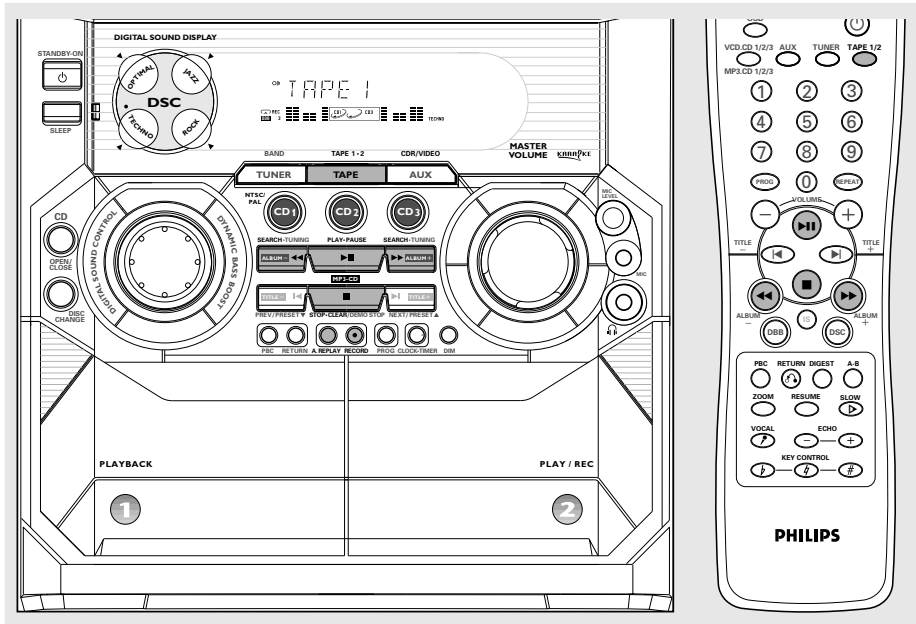

### IMPORTANT!

- Before playing a tape, check and tighten slack tape with a pencil. Slack tape may get jammed or may burst in the mechanism.
- C-120 tape is extremely thin and is easily deformed or damaged. It is not recommended for use in this system.
- Store the tapes at room temperature and do not put them too close to a magnetic field (for example, a transformer, TV or speaker).

### Loading tape

- 1 Press on the tape deck to open the tape deck door.
- 2 Load the tape with the open side downward and full spool to the left.
- 3 Close the tape deck door.

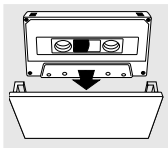

### Playing tapes

#### To playback a selected tape deck

- 1 Press **TAPE** (or **TAPE 1/2** on the remote control) repeatedly to select tape deck 1 or 2.
- 2 Press **▶||**

#### To stop playback

- Press **■**.

#### To select automatic replay or one time playback

- Press **A. REPLAY** repeatedly to select the different playback modes.  
→ "AUTO REPLAY" ( ) or "ONCE" ( ) is displayed.

**AUTO REPLAY** ...the tape will rewind automatically at the end of playback and replay again. It will replay up to a maximum of 20 times.

**ONCE** .....the tape will playback the selected side once and then stop.



## Tape Operation / Recording

### Rewinding / Fast forwarding

- 1 Stop playback, press ◀◀ or ▶▶.  
→ The tape will stop automatically at the end of rewinding or fast forwarding.
- 2 Press ■ to stop rewinding or fast forwarding.

**Note:**

– During rewinding or fast forwarding of a tape, it is also possible to select another source (VCD or TUNER, for example).

### General information on recording

- If you do not intend to record via the microphone, unplug the microphone to avoid accidental mixing with other recording source.
- For recording, use only tape of IEC type I (normal tape).
- The recording level is set automatically, regardless of the position of the Volume, DBB, DSC and so forth.
- The tape is secured at both ends with leader tape. At the beginning and end of the tape, nothing will be recorded for six to seven seconds.
- To prevent accidental recording, break out the tab on the left shoulder of the tape side you want to protect.
- If "CHECK TAPE" is displayed, the protection tab has been broken. Put a piece of clear adhesive tape over the opening.

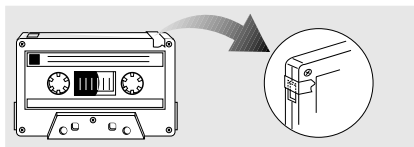
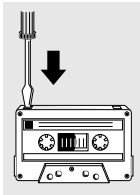

**IMPORTANT!**

- Recording is permissible if copyright or other rights of third parties are not infringed upon.
- Recording is possible only on tape deck 2.

### Preparation for recording

- 1 Press **TAPE** to select TAPE 2.
- 2 Load a recordable tape into tape deck 2 with full spool to the left.
- 3 Prepare the source to be recorded.  
**VCD** – load the disc(s).  
**TUNER** – tune to the desired radio station.  
**TAPE** – load the prerecorded tape into tape deck 1 with the full spool to the left.  
**AUX** – connect external equipment.

### When recording is in progress

→ **REC** starts flashing.

- It is not possible to listen to another source, except tape dubbing.
- It is not possible to activate the timer function during recording or tape dubbing.

### One touch recording / Recording the mixed sound

- 1 Press **VCD 1/2/3**, **TUNER** or **AUX** to select the source.
- You can connect a microphone to record the mixed sound (refer to "Karaoke - Microphone Mixing").
- 2 Start playback of the selected source.
- 3 Press **RECORD** to start recording.

### To stop recording

- Press ■ on the system.

**Note:**

– One Touch Recording is not possible in TAPE mode, "SELECT SOURCE" will be displayed.

### CD Synchronised start recording

- 1 Press **VCD 1/2/3** to select the disc.
- Press ◀ or ▶ to select the desired track to start recording.
- You can programme the tracks in the order you want them to be recorded (refer to "CD/VCD/MP3-CD Operations - Programming the disc tracks").
- 2 Press **RECORD** to start recording.  
→ The disc will start playback automatically.



## Tape Operation / Recording

### To select another track during recording

- 1 Press ►|| to interrupt recording.
- 2 Press ◀ or ▶ to select the desired track.
- 3 Press ►|| to resume recording.

### To stop recording

- Press ■.
- Recording and disc playback will stop simultaneously.

### Dubbing tapes

- 1 Press **TAPE** to select tape mode.
- 2 Load the prerecorded tape in tape deck 1.
- You can set the tape to the desired passage where recording will start.

- 3 Press **RECORD**.

→ Playing and recording will start simultaneously.  
→ "DUB" is displayed.

- Dubbing of tapes is possible on one side of the tape only. To continue recording on the reverse side, at the end of side A, flip the tape to side B and repeat the procedure.

### To stop dubbing

- Press ■.

### Notes:

- Dubbing of tapes is possible only from tape deck 1 to tape deck 2.
- To ensure good dubbing, use tapes of the same length.

## Karaoke

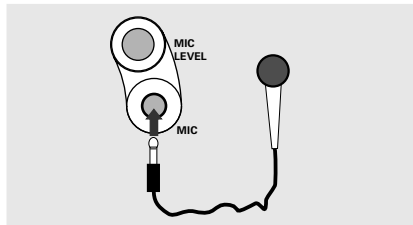

### Microphone mixing

Connect a microphone (not supplied) to the system allowing you to sing along with the music source.

- 1 Connect a microphone to the **MIC** jack.
- Before connecting the microphone, set the microphone **MIC LEVEL** to the minimum level to prevent howling sound.

- 2 Press **VCD 1/2/3**, **TUNER**, **TAPE** or **AUX** to select the source to be mixed and start playback.

- 3 Adjust the volume level of the source with **MASTER VOLUME** control.

- 4 Adjust the microphone volume with microphone **MIC LEVEL** control.

### Note:

- Keep the microphone away from the speakers to prevent howling.

**For Recording, please refer to "Tape Operation/Recording".**



## Clock/Timer

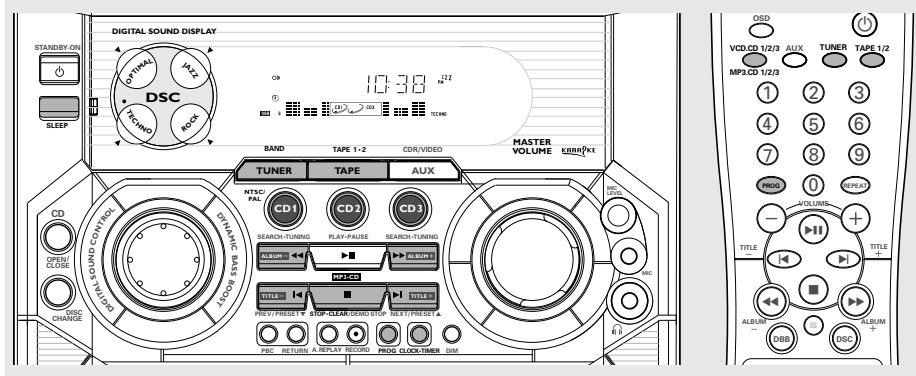

English

### View clock

The clock (if it is set) will be shown in standby mode.

### To view the clock in any source mode (VCD or TUNER for example)

- Press **CLOCK•TIMER**.
  - The clock is displayed for a few seconds.
  - If the clock has not been set, "----:--" is displayed.

### Clock setting

The clock can be set in either 12-hour or 24-hour mode ("12:00 AM" or "00:00", for example)

- 1 In standby or view clock mode, press **CLOCK•TIMER once**. In other source mode, press **CLOCK•TIMER twice**.
- 2 Press **PROG** repeatedly to select clock mode.
  - "12:00 AM" or "00:00" starts flashing.
- 3 Press **◀◀** or **▶▶** on the system repeatedly to set the hour.
- 4 Press **◀** or **▶** on the system repeatedly to set the minute.
- 5 Press **CLOCK•TIMER** again to store the setting.
  - The clock starts working.

### To exit without storing the setting

- Press **■** on the system.

### Notes:

- The clock setting will be cancelled when the power cord is disconnected or if a power failure occurs.
- During clock setting, if no button is pressed within 90 seconds, the system will exit clock setting mode automatically.

### Timer setting

The system can switch on to VCD, TUNER or TAPE mode automatically at a preset time, serving as an alarm to wake you up.

### IMPORTANT!

- Before setting the timer, ensure that the clock is set correctly.
- The timer will always be switched on after it has been set.
- The timer will not start if a recording is in progress.
- The volume of the timer will increase gradually from the minimum level to the last tuned volume level.

- 1 Press and hold **CLOCK•TIMER** for more than **two seconds** to select timer mode.
  - "12:00 AM" or "00:00" or the last timer setting starts flashing.
  -  starts flashing.



## Clock/Timer

- 2 Press **VCD 1/2/3**, **TUNER** or **TAPE** to select the desired source.
    - "CD 1 [or 2, 3] XX:XX" indicates the CD mode is selected.
    - "TU XX:XX" indicates the Tuner mode is selected.
    - "TR 1 [or 2] XX:XX" indicates the Tape mode is selected.
  - Before setting timer, make sure the music source has been prepared.
    - VCD 1/2/3** – Load the disc(s).
    - TUNER** – tune to the desired radio station.
    - TAPE** – load the prerecorded tape into tape deck.
  - 3 Press ◀ or ▶ on the system repeatedly to set the hour for the timer to start.
  - 4 Press ◀ or ▶ on the system repeatedly to set the minute for the timer to start.
  - 5 Press **CLOCK•TIMER** to store the timer.
    - "TIMER ON" is displayed, followed by the set timer "XX:XX" and the selected source.
    - ⏸ remains on the display.
  - At the preset time, the selected sound source will play.
- To exit without storing the setting**
- Press ■ on the system.

### Notes:

- When the preset time is reached and the selected disc tray is empty, the next available disc will be selected. If all the disc trays are not available, Tuner will be selected automatically.
- During timer setting, if no button is pressed within 90 seconds, the system will exit timer setting mode automatically.

### Deactivating the timer

- 1 Press and hold **CLOCK•TIMER** for more than **two seconds**.
- 2 Press ■ on the system to cancel the timer.
  - "CANCEL" is displayed and the ⏸ disappears.

### Activating the timer (for the same preset time and source)

- 1 Press and hold **CLOCK•TIMER** for more than **two seconds**.
- 2 Press **CLOCK•TIMER** again to store.
  - The last set timer information is displayed for a few seconds and ⏸ is shown.

### Sleep timer setting

The sleep timer enables the system to switch to standby mode automatically at a preset time.

- 1 Press **SLEEP** repeatedly to select a preset time.
  - The selections are as follows (time in minutes):  
15 → 30 → 45 → 60 → 90 → 120 → OFF → 15 ...
  - "SLEEP XX" or "OFF" is displayed. "XX" is the time in minutes.
- 2 When you reach the desired length of time, stop pressing the **SLEEP** button.
  - ZZ is shown, except for "OFF" mode.
  - The sleep timer is now set. Before the system switches to standby mode, a countdown of 10 seconds is displayed.  
"SLEEP 10" → "SLEEP 9" ... → "SLEEP 1" → "SLEEP"

### To check the remaining length of time after sleep timer is activated

- Press **SLEEP** once.

### To change the preset sleep timer

- Press **SLEEP** again while the remaining sleep timer is shown.
  - The display will show the next sleep timer options.

### To deactivate the sleep timer

- Press **SLEEP** repeatedly until "OFF" is displayed, or press the **STANDBY ON** button.



## External Sources

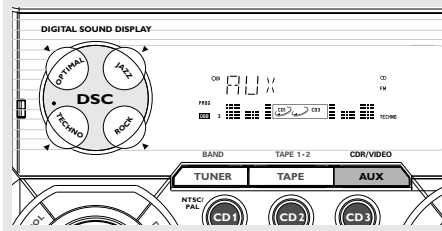

### Notes:

- All the sound control features (DSC or DBB, for example) are available for selection.
- Refer to the operating instructions for the connected equipment for details.

**For Recording, please refer to "Tape Operation/Recording".**

English

### Listening to external sources

- 1 Connect the audio out terminals of the external equipment (TV, VCR, Laser Disc player, DVD player or CD Recorder) to the **AUX/CDR IN** terminals of your system.
- 2 Press **AUX** to select external equipment.  
→ "FLUX" is displayed.

## Maintenance

### Cleaning the Cabinet

- Use a soft cloth slightly moistened with a mild detergent solution. Do not use a solution containing alcohol, spirits, ammonia or abrasives.

### Cleaning Discs

- When a disc becomes dirty, clean it with a cleaning cloth. Wipe the disc from the centre out.
- Do not use solvents such as benzene, thinner, commercially available cleaners, or antistatic spray intended for analogue records.

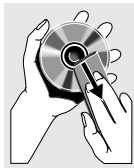

### Cleaning the disc lens

- After prolonged use, dirt or dust may accumulate at the disc lens. To ensure good playback quality, clean the disc lens with Philips CD Lens Cleaner or any commercially available cleaner. Follow the instructions supplied with cleaner.

### Cleaning the Heads and the Tape Paths

- To ensure good recording and playback quality, clean the heads (A), the capstan(s) (B), and pressure roller(s) (C) after every 50 hours of tape operation.
- Use a cotton swab slightly moistened with cleaning fluid or alcohol.
- You can also clean the heads by playing a cleaning tape once.

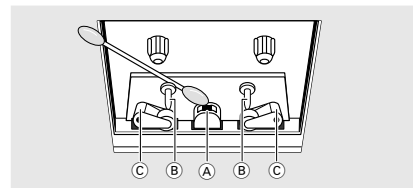

### Demagnetising the heads

- Use a demagnetising tape available at your dealer.



## Specifications

### AMPLIFIER

Output power ..... 1500 W PMPO  
 ..... 2 x 40 W RMS<sup>(1)</sup>  
 Signal-to-noise ratio ..... ≥ 67 dBA (IEC)  
 Frequency response ..... 50 – 15000 Hz  
 Input sensitivity  
 AUX/CDR In ..... 500 mV / 1V  
 Microphone ..... 3.5 mV  
 Output  
 Speakers ..... ≥ 6 Ω  
 Headphones ..... 32 Ω – 1000 Ω  
 (1) (6 Ω, 1 kHz, 10% THD)

### CD/VCD/MP3-CD PLAYER

Number of programmable tracks ..... 99  
 Frequency range ..... 20 – 20000 Hz  
 Signal-to-noise ratio ..... ≥ 80 dBA  
 Channel separation ..... ≥ 60 dB (1 kHz)  
 Total harmonic distortion ..... < 0.003%  
 MPEG 1 ..... VCD version 2.0  
 MPEG 1 Layer 3 (MP3-CD) ..... MPEG AUDIO  
 MP3-CD bit rate ..... 32-256 kbps  
 (128 kbps advised)  
 Sampling frequencies ..... 32, 44.1, 48 kHz

### RADIO RECEPTION

FM wave range ..... 87.5 – 108 MHz  
 MW wave range (9 kHz) ..... 531 – 1602 kHz  
 MW wave range (10 kHz) ..... 530 – 1700 kHz  
 Tuning grid ..... 9/10 kHz  
 Number of presets ..... 40  
 Antenna  
 FM ..... 75 Ω wire  
 AM ..... Loop antenna

### TAPE DECK

Frequency response  
 Normal tape (type I) ..... 80 – 12500 Hz (8 dB)  
 Signal-to-noise ratio  
 Normal tape (type I) ..... ≥ 48 dBA  
 Wow and flutter ..... ≤ 0.4% DIN

### SPEAKERS

System ..... double port bass reflex  
 Impedance ..... 6 Ω  
 Woofer ..... 1 x 5 1/4" full range  
 Dimensions (w x h x d) ..... 210 x 310 x 235 (mm)  
 Weight ..... 3.1 kg each

### GENERAL INFORMATION

Material ..... Polystyrene  
 AC Power ..... 110 – 127 / 220 – 240 V;  
 ..... 50/60 Hz Switchable  
 Power Consumption  
 Active ..... 80 W  
 Standby ..... < 15 W  
 Dimensions (w x h x d) ..... 265x 310x 365 (mm)  
 Weight (without speakers) ..... 6.4 kg

**Specifications and external appearance are subject to change without notice.**





## Troubleshooting

### WARNING

*Under no circumstances should you try to repair the system yourself, as this will invalidate the warranty. Do not open the system as there is a risk of electric shock.*

*If a fault occurs, first check the points listed below before taking the system for repair. If you are unable to solve a problem by following these hints, consult your dealer or service centre.*

Problem	Solution
<b>CD OPERATION</b>	
<b>"UNREADABLE DISC" is displayed.</b>	<ul style="list-style-type: none"> <li>– Check if the disc is inserted upside down.</li> <li>– Wait until the moisture condensation at the lens has cleared.</li> <li>– Replace or clean the disc, see "Maintenance".</li> <li>– Use a finalised CD-RW or a correct MP3-CD format disc.</li> </ul>
<b>"NO DISC" is displayed.</b>	<ul style="list-style-type: none"> <li>– Insert a disc.</li> </ul>
<b>No picture on TV screen.</b>	<ul style="list-style-type: none"> <li>– Connect the cable between the system and TV.</li> </ul>
<b>No colour on TV screen.</b>	<ul style="list-style-type: none"> <li>– Change the system to the respective PAL or NTSC setting.</li> </ul>
<b>Cannot adjust the TV system to PAL or NTSC.</b>	<ul style="list-style-type: none"> <li>– Remove the MP-3 CD from disc tray 1 or press DISC CHANGE to select a non MP3 disc tray</li> </ul>
<b>RADIO RECEPTION</b>	
<b>Radio reception is poor.</b>	<ul style="list-style-type: none"> <li>– If the signal is too weak, adjust the antenna or connect an external antenna for better reception.</li> <li>– Increase the distance between the Mini HiFi System and your TV or VCR.</li> </ul>
<b>TAPE OPERATION/RECORDING</b>	
<b>Recording or playback cannot be made.</b>	<ul style="list-style-type: none"> <li>– Clean deck parts, see "Maintenance".</li> <li>– Use only NORMAL (IEC I) tape.</li> <li>– Apply a piece of adhesive tape over the missing tab space.</li> </ul>
<b>The tape deck door cannot open.</b>	<ul style="list-style-type: none"> <li>– Remove and reconnect the AC power plug and switch on the system again.</li> </ul>



## Troubleshooting

### GENERAL

**The system does not react when buttons are pressed.**

- Remove and reconnect the AC power plug and switch on the system again.

**Sound cannot be heard or is of poor quality.**

- Adjust the volume.
- Disconnect the headphones.
- Check that the speakers are connected correctly.
- Check if the stripped speaker wire is clamped.
- Make sure the MP3 disc was recorded within 32-256 kbps bit rate with sampling frequencies at 48 kHz, 44.1 kHz or 32 kHz.

**The left and right sound outputs are reversed.**

- Check the speaker connections and location.

**The remote control does not function properly.**

- Select the source (VCD 1/2/3 or TUNER, for example) before pressing the function button (▶, ◀, ▶▶).
- Reduce the distance between the remote control and the system.
- Insert the batteries with their polarities (+/- signs) aligned as indicated.
- Replace the batteries.
- Point the remote control directly towards the IR sensor .

**The timer is not working.**

- Set the clock correctly.
- Press and hold CLOCK•TIMER to switch on the timer.
- If recording or tape dubbing is in progress, stop recording.

**The Clock/Timer setting is erased.**

- Power has been interrupted or the power cord has been disconnected. Reset the clock/timer.

**The system displays features automatically.**

- Press and hold ■ on the system to switch off the demonstration.