



Mini Hi-Fi System



Let's make things better.



PHILIPS



México

NOM-135-1
NMXE

Es necesario que lea cuidadosamente su instructivo de manejo.

	PRECAUCIÓN - ADVERTENCIA	
	No abrir, riesgo de choque eléctrico	
ATENCIÓN		
Verifique que el voltaje de alimentación sea el requerido para su aparato		
Para evitar el riesgo de choque eléctrico, no quite la tapa. En caso de requerir servicio, dirijase al personal calificado.		

Descripción: **Minisistema de Audio**
Modelo : **FW-C505/21**
Alimentación: **110-127 / 220-240V~; 50-60 Hz**
Consumo: **100 W**
Importador: **Philips Mexicana, S.A. de C.V.**
Domicilio: **Norte 45, # 669,
Col. Industrial Vallejo
C.P. 02300 México D.F.,
Tel. 5728-4200**
Localidad y Tel:
Exportador: **Philips Electronics HK, Ltd.**
País de Origen: **China**
N° de Serie: _____

**LEA CUIDADOSAMENTE ESTE INSTRUCTIVO
ANTES DE USAR SU APARATO.**

CAUTION

Use of controls or adjustments or performance of procedures other than herein may result in hazardous radiation exposure or other unsafe operation.

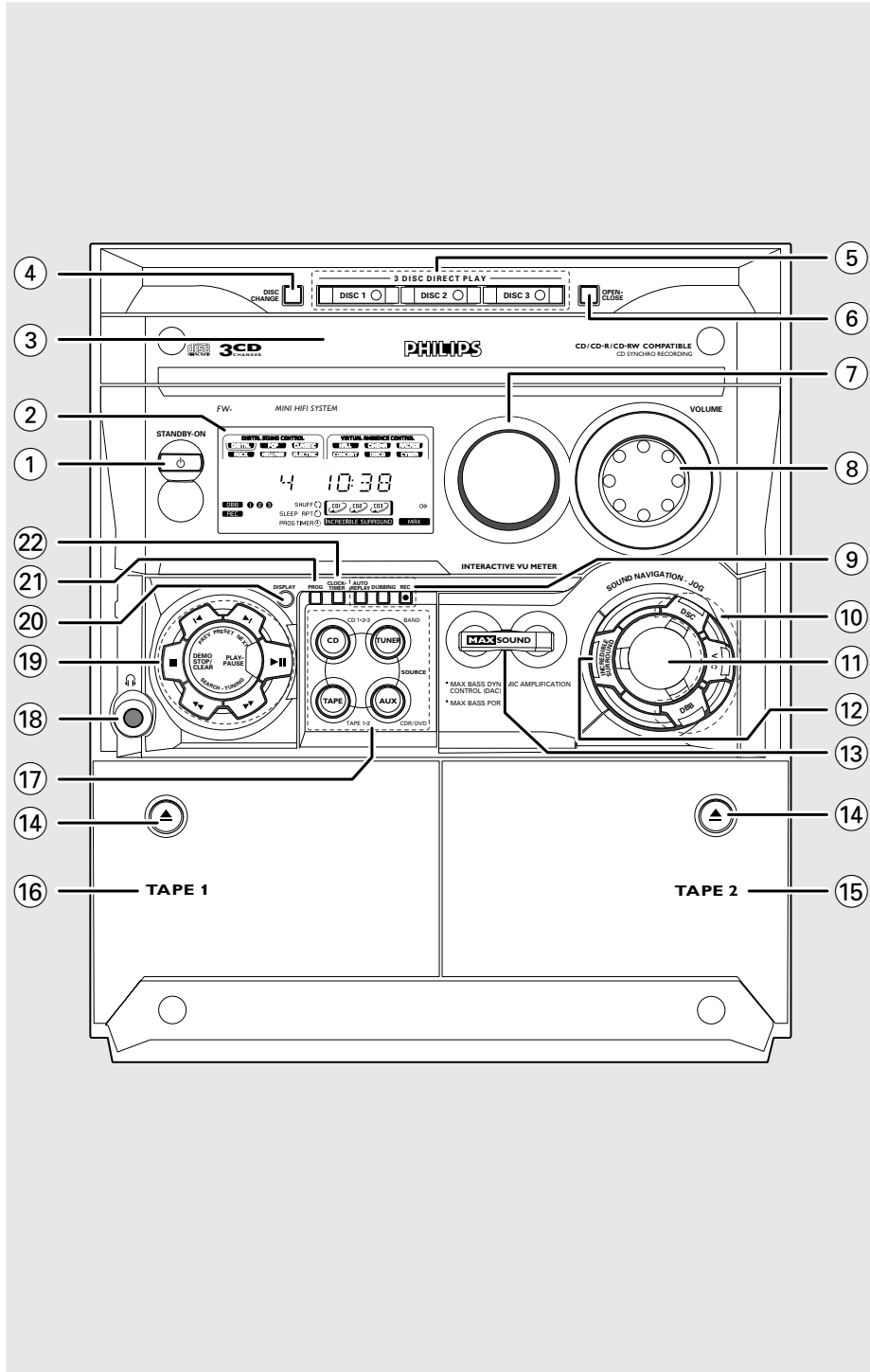

3



DEMO MODE

To turn ON

Press & HOLD



button

for 5 seconds

To turn OFF

Press & HOLD



button

for 5 seconds

PLUG & PLAY

1



Plug in the unit

2



Follow instructions
in the display

3



Press "PLAY"



English 6

Français 29

Español 52

中文 75

English

Français

Español

中文





English

Contents

General Information

Environmental Information	7
Supplied Accessories	7
Safety Information	7

Preparations

Rear Connections	8-9
Optional Connections	9
Inserting batteries into the remote control	9

Controls

Controls on the system and remote control	10-11
---	-------

Basic Functions

Plug and Play	12
Demonstration mode	13
Switching the system on	13
Switching the system to Standby mode	13
Power Saving Automatic Standby	13
Display mode	13
Volume Control	14
Sound Navigation	14-15

CD Operation

Discs for Playback	16
Loading Discs	16
Disc Playback	17
Programming the disc tracks	17-18
Repeat	18
Shuffle	18

Radio Reception

Storing Preset Radio Stations	19-20
Tuning to Preset Radio Stations	20
Erasing a Preset Radio Station	20
Changing Tuning Grid	20

Tape Operation/Recording

Tape Playback	21-22
General Information on Recording	22
Preparation for Recording	22
One Touch Recording	22
CD Synchro Recording	23
Dubbing Tapes	23

External Sources

Listening to External Sources	23
-------------------------------------	----

Clock/Timer

View Clock	24
Clock Setting	24
Timer Setting	24-25
Sleep Timer Setting	25

Specifications

.....	26
-------	----

Maintenance

.....	27
-------	----

Troubleshooting

.....	27-28
-------	-------



General Information

IMPORTANT!
PLEASE NOTE THAT THE VOLTAGE SELECTOR LOCATED AT THE REAR OF THIS SYSTEM IS PRESET AT 220V FROM THE FACTORY. FOR COUNTRIES THAT OPERATE AT 110V-127V, PLEASE ADJUST TO 110V-127V BEFORE YOU SWITCH ON THE SYSTEM.

Environmental Information

All unnecessary packaging has been omitted. We have tried to make the packaging easy to separate into three materials: cardboard (box), polystyrene foam (buffer) and polyethylene (bags, protective foam sheet).

Your system consists of materials which can be recycled and reused if disassembled by a specialised company. Please observe the local regulations regarding the disposal of packaging materials, exhausted batteries and old equipment.

Supplied accessories

- Remote control
- Batteries (two AA size) for remote control
- AM loop antenna
- FM wire antenna
- AC power cord

Safety Information

- Before operating the system, check that the operating voltage indicated on the typeplate (or the voltage indication beside the voltage selector) of your system is identical with the voltage of your local power supply. If not, please consult your dealer.
- Place the system on a flat, hard and stable surface.
- Place the system in a location with adequate ventilation to prevent internal heat build-up in your system. Allow at least 10 cm (4 inches) clearance from the rear and the top of the unit and 5 cm (2 inches) from each side.
- Do not expose the system, batteries or discs to excessive moisture, rain, sand or heat sources caused by heating equipment or direct sunlight.
- If the system is brought directly from a cold to a warm location, or is placed in a very damp room, moisture may condense on the lens of the disc unit inside the system. Should this occur; the CD player would not operate normally. Leave the power on for about one hour with no disc in the system until normal playback is possible.
- The mechanical parts of the set contain self-lubricating bearings and must not be oiled or lubricated.
- **When the system is switched to Standby mode, it is still consuming some power. To disconnect the system from the power supply completely, remove the AC power plug from the wall socket.**





Preparations

English

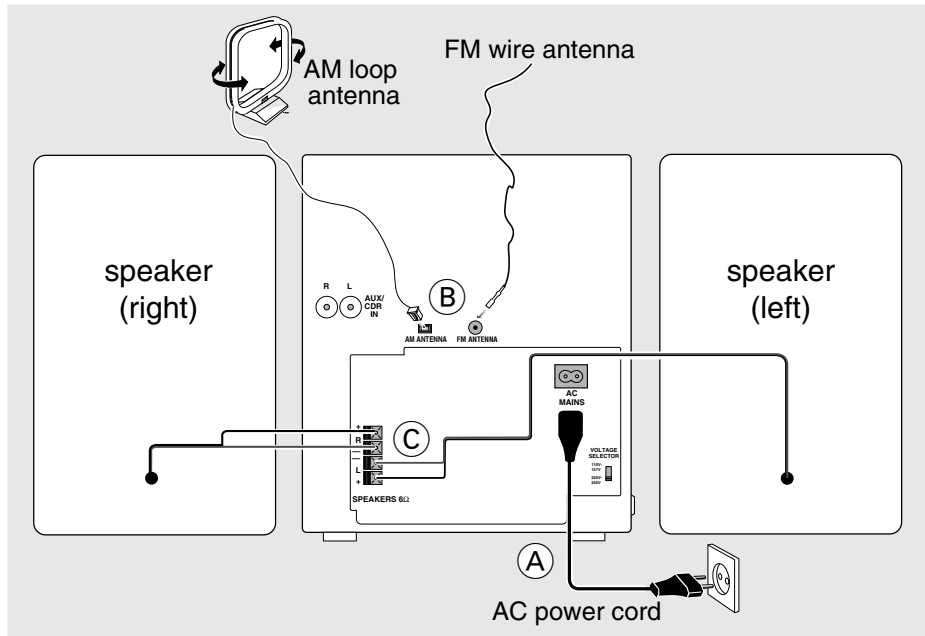

Rear Connections

The type plate is located at the rear of the system.

A Power

Before connecting the AC power cord to the wall outlet, ensure that the following are done;

- If your system is equipped with a Voltage Selector, set the VOLTAGE SELECTOR to the local power line voltage.



- All other connections have been made.

WARNING!

- For optimal performance, use only the original power cable.
- Never make or change any connections with the power switched on.

To avoid overheating of the system, a safety circuit has been built in. Therefore, your system may switch to Standby mode automatically under extreme conditions. If this happens, let the system cool down before reusing it (not available for all versions).

B Antennas Connection

Connect the supplied AM loop antenna and FM antenna to the respective terminals. Adjust the position of the antenna for optimal reception.

AM Antenna

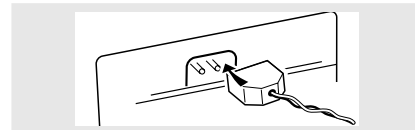

- Position the antenna as far as possible from a TV, VCR or other radiation source.

FM Antenna

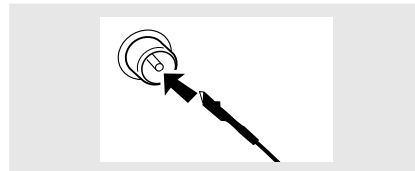

- For better FM stereo reception, connect an outdoor FM antenna to the FM ANTENNA terminal.



Preparations

Speakers Connection

Front Speakers

Connect the speaker wires to the SPEAKERS (FRONT) terminals, right speaker to "R" and left speaker to "L", coloured (marked) wire to "+" and black (unmarked) wire to "-".

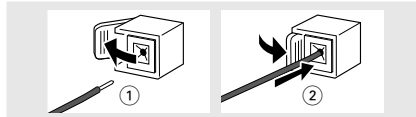

- Fully insert the stripped portion of the speaker wire into the terminal as shown.

Notes:

- For optimal sound performance, use the supplied speakers.
- Do not connect more than one speaker to any one pair of + / - speaker terminals.
- Do not connect speakers with an impedance lower than the speakers supplied. Please refer to the SPECIFICATIONS section of this manual.

Inserting batteries into the Remote Control

Insert two batteries (Type R06 or AA) into the remote control with the correct polarity as indicated by the + and - symbols inside the battery compartment.

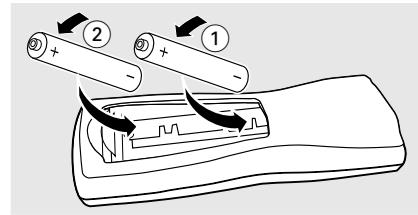

CAUTION!

- Remove batteries if they are exhausted or will not be used for a long time.
- Do not use old and new or different types of batteries in combination.
- Batteries contain chemical substances, so they should be disposed off properly.

English

Optional Connections

The optional equipment and connecting cords are not supplied. Refer to the operating instructions of the connected equipment for details.

Connecting other equipment to your system

Connect the audio left and right OUT terminals of a TV, VCR, Laser Disc player, DVD player or CD Recorder to the **AUX/CDR IN** terminals.

Notes:

- If you are connecting equipment with a mono output (a single audio out terminal), connect it to the AUX/CDR IN left terminal. Alternatively, you can use a "single to double" cinch cable (still be mono sound).



Controls (main system's illustration on page 3)

Controls on the system and remote control

- ① **STANDBY ON**
- to switch the system on or to Standby mode.
- ② **DISPLAY SCREEN**
- to view the current status of the system.
- ③ **DISC TRAY**
- ④ **DISC CHANGE**
- to change disc(s).
- ⑤ **DISC 1 / DISC 2 / DISC 3 (CD DIRECT)**
- to select a disc tray for playback.
- ⑥ **OPEN•CLOSE**
- to open or close the disc tray.
- ⑦ **INTERACTIVE VU METER**
- to show the VU (volume unit) meter in music or volume mode depending on the display mode selected.
- ⑧ **VOLUME**
- to increase or decrease the volume.
- ⑨ **Tape Deck Operation**
- AUTO REPLAY**
- to select continuous playback in either AUTO PLAY or ONCE mode only.
- DUBBING**
- to dub a tape.
- REC**
- to start recording on tape deck 2.
- ⑩ **SOUND NAVIGATION**
- to select the desired sound feature : DSC, VAC, or DBB.
- ⑪ **JOG CONTROL**
- to select the desired sound effect for the selected sound feature.
- DSC DIGITAL, ROCK, POP, NEWAGE, CLASSIC or ELECTRIC.
- VAC HALL, CONCERT, CINEMA, DISCO, ARCADE or CYBER.
- DBB BEAT, PUNCH or BLAST.
- ⑫ **INCREDIBLE SURROUND (IS)**
- to activate or deactivate the surround sound effect.
- ⑬ **MAX SOUND (MAX ON/OFF)**
- to activate or deactivate the optimal mix of various sound features.
- ⑭
- to open the tape deck door.
- ⑮ **TAPE DECK 2**
- ⑯ **TAPE DECK 1**
- ⑰ **SOURCE** – to select the following:
- CD / (CD 1•2•3)**
- to select disc tray 1, 2 or 3.
- TUNER / (BAND)**
- to select waveband : FM or MW.
- TAPE / (TAPE 1•2)**
- to select tape deck 1 or 2.
- AUX / (CDR/DVD)**
- to select a connected external source : CDR/DVD or AUX (auxiliary) mode.
- ⑱
- to connect headphones.
- ⑲ **Mode Selection**
- PLAY PAUSE ▶ II**
- for CD to start or interrupt playback.
- for TAPE to start playback.
- for PLUG & PLAY... (on the system only) to initiate and start plug & play mode.
- SEARCH•TUNING ◀▶▶**
- for CD to search backward/forward.
- for TUNER to tune to a lower or higher radio frequency.
- for TAPE to rewind or fast forward.
- for CLOCK (on the system only) to set the hour.
- DEMO STOP/CLEAR ■**
- for CD to stop playback or to clear a programme.
- for TUNER to stop programming.
- (on the system only) to delete the preset radio station.
- for TAPE to stop playback or recording.
- to reset tape counter number.
- for DEMO (on the system only) to activate/deactivate the demonstration.
- for CLOCK (on the system only) to exit clock setting or cancel timer.
- for PLUG & PLAY... (on the system only) to exit plug & play mode.



Controls

PREV / PRESET / NEXT ◀ ▶

for CD to skip to the beginning of the current, previous, or next track.
 for TUNER to select a preset radio station.
 for CLOCK (on the system only) to set the minute.

20 DISPLAY

– to select different screen display mode :
 NORMAL, MODE 1, MODE 2, or MODE 3.

21 PROG (PROGRAM)

for CD to programme disc tracks.
 for TUNER to programme preset radio stations.
 for CLOCK (on the system only) to select 12- or 24-hour clock mode.

22 CLOCK•TIMER

– to view the clock, set the clock or set the timer.

23 MUTE

– to interrupt or resume sound reproduction.

24 CLOCK

– to view the clock display.

25 REPEAT

– to playback track(s)/disc(s)/programme repeatedly.

26 SHUFFLE

– to playback all available discs and their tracks/ programme in random order.

27 TIMER ON/OFF

– to activate or deactivate the timer.

28 SLEEP

– to activate, deactivate or set the sleep timer.

29 ⏻

– to switch the system to Standby mode.

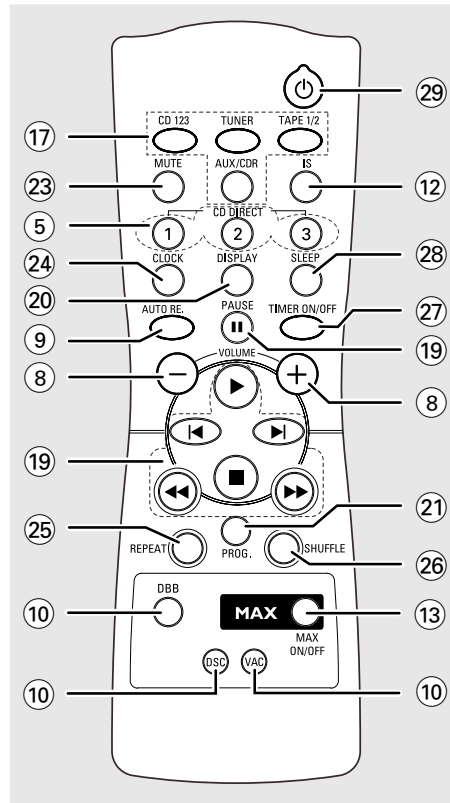

English

Notes for remote control:

- First, select the source you wish to control by pressing one of the source select keys on the remote control (CD 123 or TUNER, for example).
- Then select the desired function (▶, ◀, ▶|, for example).



Basic Functions

English

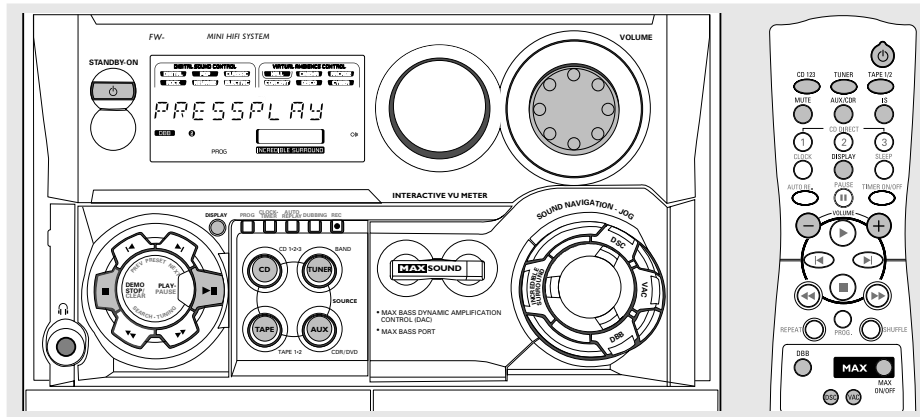

IMPORTANT!
Before you operate the system, complete the preparation procedures.

Plug and Play

Plug and Play allows you to store all available radio stations automatically.

If Plug and Play has not been installed

- 1 When you turn on the system, "AUTO INSTALL - PRESS PLAY" will be displayed.
- 2 Press **PLAY** ► on the system to start installation.
 - "INSTALL" will be displayed and followed by "TUNER" and then "AUTO".
 - **PROG** will start flashing.
 - The system will search for all radio stations on the FM band, then the MW band.
 - All available radio stations with sufficient signal strength will be stored automatically.
 - The system will stop searching when all the available radio stations are stored or when the memory for 40 preset radio stations is used.
 - The last preset radio station will play when Plug and Play is completed.

To reinstall Plug and Play

- 1 In Standby or Demonstration mode, press and hold **PLAY** ► on the system until "AUTO INSTALL - PRESS PLAY" is displayed.
- 2 Press **PLAY** ► again to start installation.
 - All previously stored radio stations will be replaced.

To exit without storing the Plug and Play

- Press **■** on the system.

Notes:

- When the power is turned on, the disc tray may open and close to initialise the system.
- If you do not complete Plug and Play installation, Plug and Play will be reinitiated the next time you turn on the power.
- If no stereo frequency is detected during Plug and Play, "CHECK ANTENNA" will be displayed.
- During Plug and Play, if no button is pressed within 15 seconds, the system will exit Plug and Play mode automatically.



Basic Functions

Demonstration mode

The system has a demonstration mode that shows the various features offered by the system.

To activate the demonstration

- In Standby mode, press and hold **DEMO STOP** ■ on the system until "DEMO ON" is displayed.
→ The demonstration will begin.

To deactivate the demonstration

- Press and hold **DEMO STOP** ■ on the system until "DEMO OFF" is displayed.
→ The system will switch to Standby mode.

Note:

– Even if you remove the AC power cord and reconnect it to the wall socket, the demonstration will remain off until you activate it again.

Switching the system on

In Standby/Demonstration mode

- Press **STANDBY ON**.
→ The system will switch to the last selected source.
- Press **CD, TUNER, TAPE, AUX** (or **CD 123, TUNER, TAPE 1/2** or **AUX/CDR** on the remote control).
→ The system will switch to the selected source.
- Press any one of the DISC DIRECT PLAY buttons or **OPEN•CLOSE**.
→ The system will switch to CD mode.

Switching the system to Standby mode

In Demonstration mode

- Press and hold **DEMO STOP** ■ on the system.

In any other source mode

- Press **STANDBY ON** (or ⏻ on the remote control).
→ The clock will appear on the display when the system is in Standby mode.

Power Saving Automatic Standby

As a power-saving feature, the system will automatically switch to Standby mode if you do not press any buttons within 30 minutes after a disc or tape has stopped playing.

Display mode

There are four different display modes for selection.

- Press **DISPLAY** repeatedly to select NORMAL, MODE 1, MODE 2, or MODE 3.

NORMAL All available LEDs will light up and the display screen will have full brightness. The VU meter will be in music mode.

MODE 1 All available LEDs will light up and the display screen will have full brightness. The VU meter will be in volume mode.

MODE 2 All available LEDs will light up and the display screen will be at half brightness. The VU meter will be in music mode.

MODE 3 The display screen will be at half brightness. The VU meter and all LEDs will be off.



Basic Functions

Volume Control

Adjust **VOLUME** to increase (turn knob clockwise or press **VOLUME +**) or decrease (turn knob anti-clockwise or press **VOLUME -**) the sound level.

To listen through the headphones

- Connect the headphones plug to the  socket at the front of the system.
→ The speakers will be muted.

To switch off the volume temporarily

- Press **MUTE** on the remote control.
→ Playback will continue without sound and "MUTE" will be displayed.
- To restore the volume, press **MUTE** again or increase the **VOLUME** level.

Sound Navigation

For optimal sound listening, select only one of the following navigation sound controls at a time : MAX sound, DSC or VAC.

MAX Sound

MAX sound provides the best mixture of various sound features (DSC, VAC, DBB for example).

- Press **MAX SOUND** (or **MAX ON/OFF** on the remote control) repeatedly to activate/deactivate the optimal sound.
→ If activated,  will appear on the display and the MAX SOUND button lights up.
→ If deactivated, "MAX OFF" will be displayed.



Note:

- When MAX sound is selected, all other sound navigation will switch off automatically.

DSC (Digital Sound Control)

The DSC feature enables you to adjust the system to suit your type of music.

- 1 Press **DSC**.
→ DSC button lights up
- 2 Adjust the **JOG CONTROL** (or press **DSC** on the remote control repeatedly) to select the desired Digital Sound Control effect : DIGITAL, ROCK, POP, NEWAGE, CLASSIC or ELECTRIC.
→ The selected DSC will be highlighted.

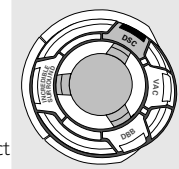

Note:

- For a neutral sound effect, select CLASSIC.

VAC (Virtual Ambience Control)

The VAC feature enables you to adjust the system to select a type of environment.

- 1 Press **VAC**.
→ VAC button lights up.
- 2 Adjust the **JOG CONTROL** (or press **VAC** on the remote control repeatedly) to select the desired Virtual Ambience Control effect : HALL, CONCERT, CINEMA, DISCO, ARCADE or CYBER.
→ The selected VAC will be highlighted.

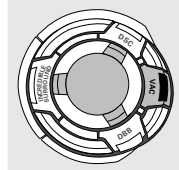

Note:

- When you select VAC, Incredible Surround will switch on automatically.



Basic Functions

DBB (Dynamic Bass Boost)

There are three DBB settings to enhance the bass response.

- 1 Press **DBB**.
→ DBB button lights up.
- 2 Adjust the **JOG CONTROL** (or press **DBB** on the remote control repeatedly) to select the desired Dynamic Bass Boost level : BEAT, PUNCH, BLAST or DBB OFF.

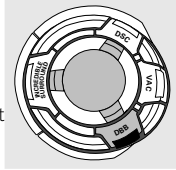

- If "BEAT" is selected, **DBB 1** will appear on the display.
- If "PUNCH" is selected, **DBB 2** will appear on the display.
- If "BLAST" is selected, **DBB 3** will appear on the display.
- If "DBB OFF" is selected, DBB will be deactivated.

Note:

– Some discs or tapes might be recorded in high modulation, which causes a distortion at high volume. If this occurs, deactivate DBB or reduce the volume.

Automatic DSC-DBB / VAC-DBB selection

The best DBB setting is generated automatically for each DSC or VAC selection. You can manually select the DBB setting that best suits your listening environment.

Incredible Surround

The Incredible Surround magnifies the virtual distance between the front speakers for an incredibly wide, enveloping, stereo effect.

- Press **INCREDIBLE SURROUND** (or **IS** on the remote control) repeatedly to activate/ deactivate the surround sound effect.

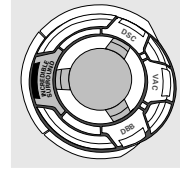

- If activated, **INCREDIBLE SURROUND** will appear on the display and the INCREDIBLE SURROUND button lights up.
- If deactivated, "IS OFF" will be displayed.

English





CD Operation

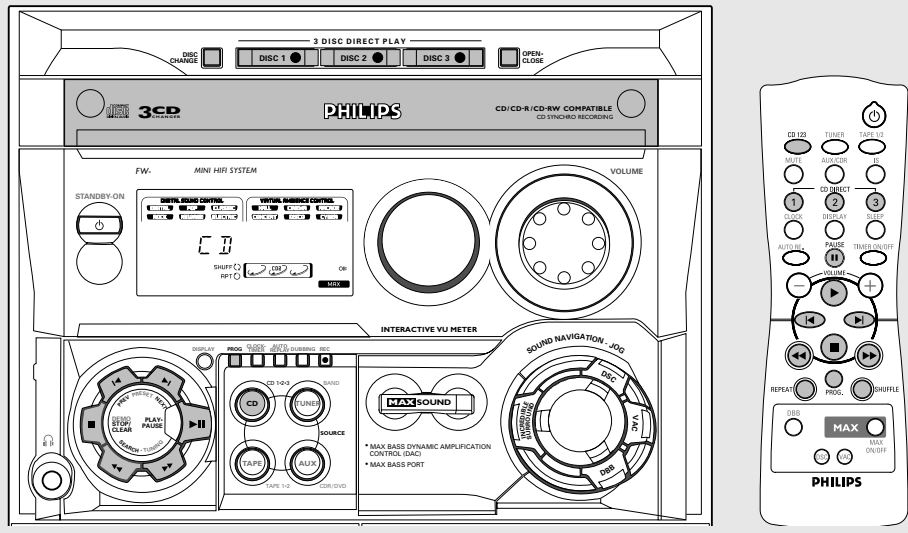

IMPORTANT!

- This system is designed for regular discs. Therefore, do not use any accessories such as disc stabiliser rings or disc treatment sheets, etc., as offered on the market, because they may jam the changer mechanism.
- Do not load more than one disc into each tray.

Discs for Playback

This system can playback all digital audio CD, finalised digital audio CD-Recordable (CDR) discs and finalised digital audio CD-Rewritable (CDRW) discs.



Loading Discs

- 1 Press **CD** to select CD mode.
- 2 Press **OPEN•CLOSE** to open the disc tray.
- 3 Load up to two discs on the individual disc trays. To load the third disc, press **DISC CHANGE**.
→ The disc tray will rotate until the empty tray is ready for loading.

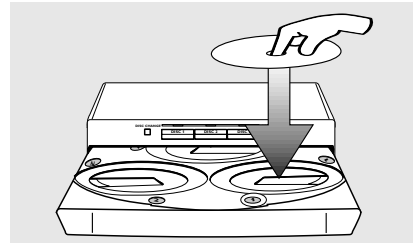

- 4 Press **OPEN•CLOSE** to close the disc tray.
→ "READING" will be displayed. The selected disc, total number of tracks and the playing time will appear on the display.
→ A lighted button indicates that a disc is loaded on the disc tray.

Notes:

- Load the discs with the label side facing up.
- To ensure good system performance, wait until the disc tray completely reads the disc(s) before proceeding.



CD Operation

Disc Playback

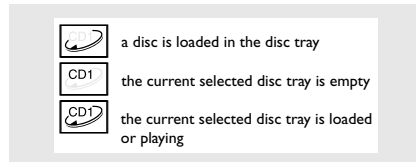

To play all discs on the disc tray

- Press **PLAY** ▶.
- All the available discs will play once, then stop.
- During playback, the selected disc tray, track number and elapsed playing time of the current track will appear on the display.

To play one disc only

- Press the DISC DIRECT PLAY button : **DISC 1**, **DISC 2** or **DISC 3**.
- The selected disc will play once, then stop.

To interrupt playback

- Press **PAUSE** II
- To resume playback, press **PLAY** ▶ again.

To stop playback

- Press ■.

To search for a particular passage during playback

- Press and hold ◀◀ or ▶▶ and release it when the desired passage is located.
- During searching, the volume will be reduced.

To select a desired track

- Press ◀ or ▶ repeatedly until the desired track appears on the display.
- If playback is stopped, press **PLAY** ▶ to start playback.

Note:

- In Shuffle mode, pressing ◀ will cause the player to skip only to the beginning of the current track.

To skip to the beginning of the current track during playback

- Press ◀ once.

Replace discs during playback

- 1 Press **DISC CHANGE**.
 - 2 To change the inner disc, press **DISC CHANGE** again.
- "DISC CHANGE" will be displayed and the disc will stop playing.
- The disc tray will close to retrieve the inner disc, then reopen with the inner disc accessible.

Programming the disc tracks

Programming tracks is possible when playback is stopped. Up to 40 tracks can be stored in the memory in any order.

- 1 Load the desired discs on the disc tray (refer to "Loading Discs").
 - 2 Press **PROG** to start programming.
 - 3 Press **CD** (CD 1•2•3) or **DISC 1/2/3** button to select a disc.
 - 4 Press ◀ or ▶ repeatedly to select the desired track.
 - 5 Press **PROG** to store the track.
- Repeat **steps 3–5** to store other discs and tracks.
 - 6 Press **PLAY** ▶ to start programme playback.
- "PLAY PROGRAM" will be displayed.
- To end programming without starting playback, press ■ once.
 - The total number of tracks programmed and the total playing time will appear on the display.

Notes:

- If the total playing time is more than "99:59" or if one of the programmed tracks has a number greater than 30, then "- : -" will appear on the display instead of the total playing time.
- If you attempt to programme more than 40 tracks, "PROGRAM FULL" will be displayed.
- If you press any of the DISC DIRECT PLAY buttons, the system will play the selected disc or track, and the stored programme will be ignored temporarily. The PROG symbol also will disappear temporarily from the display. It will reappear when playback of the selected disc ends.
- During programming, if no button is pressed within 20 seconds, the system will exit the Programme mode automatically.



CD Operation

To review the programme

- Stop playback and press ◀ or ▶ repeatedly.
- To exit review mode, press ■.

To erase the entire programme

- Press ■ **once** when playback is stopped or **twice** during playback.
 - "PROGRAM CLEAR" will be displayed.
 - **PROG** will disappear from the display.

Note:

– The programme will be erased when the system is disconnected from the power supply or when the disc tray is opened.

Repeat

The current track, a disc, all available discs or all programmed tracks can be played repeatedly.

- 1 Press **REPEAT** on the remote control repeatedly to select various repeat modes.
 - **In normal playback**
 - "TRACK" – to repeat the current track.
 - "DISC" – to repeat the entire disc.
 - "ALL DISC" – to repeat all available discs.
 - **RPT** ⏪ appears on the display.
 - **In programme playback**
 - "TRACK" – to repeat the current programmed track.
 - "PROGRAM" – to repeat all programmed tracks.
 - **RPT** ⏪ and **PROG** will appear on the display.
 - The selected track/disc(s)/programme will now be played repeatedly until you press ■.
- 2 To resume normal playback, press **REPEAT** until the "OFF" mode is displayed.
 - **RPT** ⏪ will disappear from the display.

Note:

– Selecting **SHUFFLE** during repeat playback will cancel all repeat modes.

Shuffle

All the available discs and their tracks or all the programmed tracks can be played in random order:

- 1 Press **SHUFFLE** on the remote control.
 - "SHUFFLE" and **SHUFF** ⏪ will appear on the display.
 - The discs and the tracks will be played in random order until you press ■.
- 2 To resume normal playback, press **SHUFFLE** again.
 - **SHUFF** ⏪ will disappear from the display.

When you select REPEAT mode during shuffling

- **In normal shuffled playback**
 - "TRACK" and "ALL DISC" repeat modes are available for selection.
 - **RPT** ⏪ and **SHUFF** ⏪ will appear on the display.
- **In programme shuffled playback**
 - "TRACK" or "PROGRAM" repeat modes are available for selection.
 - **RPT** ⏪, **SHUFF** ⏪ and **PROG** will appear on the display.

For Recording, please refer to "Tape Operation/Recording".



Radio Reception

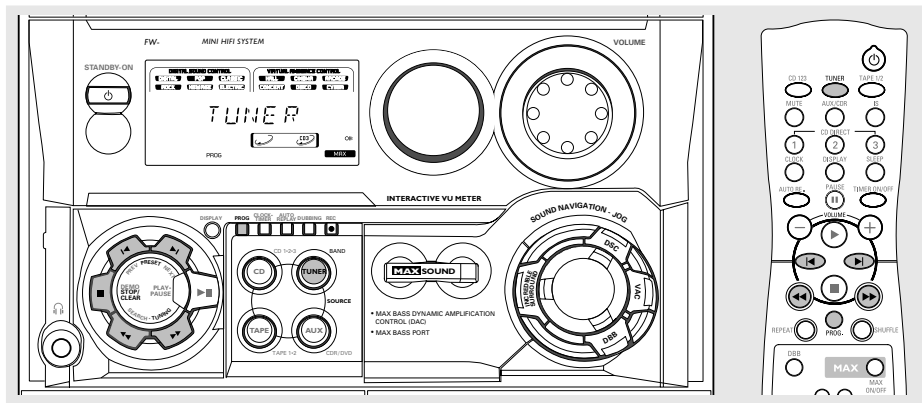

English

Storing Preset Radio Stations

You can store up to 40 preset radio stations in the memory.

Automatic Preset Programming

- Plug and Play setting (refer to "Basic Functions - Plug and Play").
OR

- 1 Press **TUNER** (BAND) to select TUNER mode.
→ "TUNER" will be displayed. A few seconds later, the current radio frequency will appear on the display.
→ If an FM station is received in stereo, will appear on the display.

To begin automatic preset from a desired preset number

- Press or to select the desired preset number.
→ If a radio station has been stored in one of the presets, it will not be stored again under another preset number.
- 2 Press and hold **PROG** until "AUTO" appears on the display.
→ **PROG** will start flashing.
→ The system will start searching for all radio stations on the FM band, then the MW band.
→ All available radio stations with sufficient signal strength will be stored automatically.
→ The system will stop searching when all the available radio stations are stored or when the memory for 40 preset radio stations is used.
→ The last preset radio station will then be played when completed.

To stop storing the automatic preset

- Press **PROG** or on the system.

Note:

– If no preset number is selected, automatic preset will begin from preset (1) and all your former presets will be overridden.

Manual Preset Programming

- 1 Press **TUNER** (BAND) repeatedly to select the desired waveband : FM or MW.
 - 2 Press **PROG**.
→ **PROG** will start flashing.
→ The next available preset number will be displayed for selection.
 - 3 Press and hold or until the frequency indication starts to change, then release.
→ The display will show "SEARCH" until a radio station with sufficient signal strength is found.
- #### To store the radio station to another preset number
- Press or to select the desired preset number.
- 4 Press **PROG** again to store the radio station.
→ **PROG** will disappear from the display.
- Repeat **steps 2–4** to store other preset radio stations.

Tuning to a weak radio station

- Press or briefly and repeatedly until the optimal reception is found.

To stop storing the manual preset

- Press on the system.



Radio Reception

Notes:

- If you attempt to store more than 40 preset radio stations, "PROGRAM FULL" will be displayed.
- During programming, if no button is pressed within 20 seconds, the system will exit the Programme mode automatically.

Tuning to Preset Radio Stations

- Once you've preset the radio stations, press ◀ or ▶ to select the desired preset number.
 - The preset number, radio frequency, and waveband will appear on the display.

Erasing a Preset Radio Station

- 1 Press ◀ or ▶ to select the preset radio station to be erased.
- 2 Press and hold ■ on the system until "PRESET DELETE" appears on the display.
 - The radio frequency remain on the display.
 - The preset numbers of all other preset radio stations in the band with higher numbers are also decreased by one.
- Repeat **steps 1–2** to erase other preset radio stations.

Changing Tuning Grid *(not available for all versions)*

In North and South America, the frequency step between adjacent channels in the MW band is 10 kHz (9 kHz in some areas). The preset frequency step in the factory is 9 kHz.

Changing the tuning grid will erase all previously stored preset radio stations.

- 1 Disconnect the system from the AC power supply (pull out the AC power cord).
- 2 While holding down **TUNER** and ▶▶ on the system, reconnect the system to the AC power supply.
 - The display will show "GRID 9" or "GRID 10".

Notes:

- GRID 9 and GRID 10 indicate that the tuning grid is in step of 9 kHz and 10 kHz respectively.
- The FM tuning grid also will be changed from 50 kHz to 100 kHz or vice versa.

For Recording, please refer to "Tape Operation/Recording".



Tape Operation/Recording

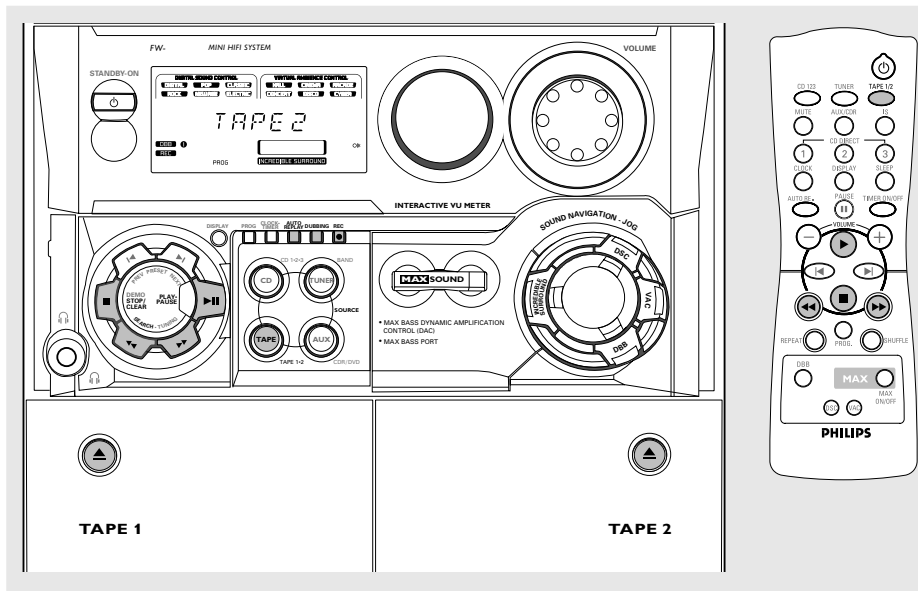

English

IMPORTANT!

- Before playing a tape, check and tighten slack tape with a pencil. Slack tape may get jammed or may burst in the mechanism.
- C-120 tape is extremely thin and is easily deformed or damaged. It is not recommended for use in this system.
- Store the tapes at room temperature and do not put them too close to a magnetic field (for example, a transformer, TV or speaker).

Tape Playback

- 1 Press **▲** to open the tape deck door.
- 2 Insert a recorded tape and close the tape door.
- Load the tape with the open side down and the full spool to the left.

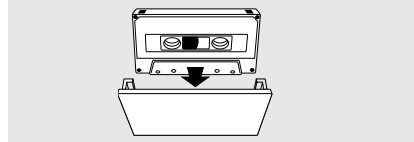

- 3 Press **TAPE** (TAPE 1•2) repeatedly to select tape deck 1 or tape deck 2.
→ The selected tape deck number is displayed.
- 4 Press **PLAY** **▶** to start playback.

To stop playback

- Press **■**.



Tape Operation/Recording

To change the playback mode

- Press **AUTO REPLAY** repeatedly to select the different playback modes.
→ "AUTO REPLAY" (⏮) or "ONCE" will appear on the display.

AUTO REPLAY ...the tape will rewind automatically at the end of playback and replay again. It will replay up to a maximum of 20 times until you press ■.

ONCEthe tape will playback the selected side once and then stop.

To rewind or fast forward when playback is stopped

- 1 Press ◀ or ▶.
- 2 Press ■ when you reached the desired passage.

To reset tape counter number

- When in stop mode, press ■.
→ "T 1 000" or "T2 000" will be displayed.

Notes:

- The tape counter will automatically set to zero after detecting end of tape.

General Information on Recording

- For recording, use only tape of IEC type I (normal tape).
- The recording level is set automatically, regardless of the position of the Volume, VAC, DSC and so forth.
- The tape is secured at both ends with leader tape. At the beginning and end of the tape, nothing will be recorded for six to seven seconds.
- To prevent accidental recording, break out the tab on the left shoulder of the tape side you want to protect.

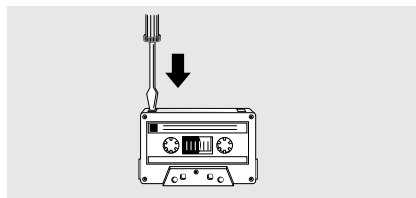

- If "CHECK TAPE" is displayed, the protection tab has been broken. Put a piece of clear adhesive tape over the opening.

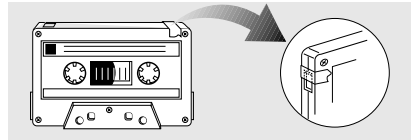

IMPORTANT!

- Recording is permissible if copyright or other rights of third parties are not infringed upon.
- Recording is possible only on tape deck 2.

Preparation for Recording

- 1 Press **TAPE** (TAPE 1•2) to select TAPE 2.
- 2 Load a recordable tape into tape deck 2 with full spool to the left.
- 3 Prepare the source to be recorded.
CD – load the disc(s).
TUNER – tune to the desired radio station.
TAPE – load the prerecorded tape into tape deck 1 with the full spool to the left.
AUX – connect external equipment.

When recording is in progress

- **REC** starts flashing.
- It is not possible to listen to another sources except when dubbing tapes.
- It is not possible to activate the timer function.

One Touch Recording

- 1 Press **CD, TUNER** or **AUX** to select the source.
- 2 Start playback of the selected source.
- 3 Press **REC** to start recording.

To stop recording

- Press ■ on the system.

Note:

- One Touch Recording is not possible in TAPE mode, "SELECT SOURCE" will be displayed.



Tape Operation/Recording

CD Synchro Recording

- 1 Press **CD 1•2•3** to select the disc.
 - Press **◀** or **▶** to select the desired track to start recording.
 - You can programme the tracks in the order you want them to be recorded (refer to "CD Operation - Programming the disc tracks").
- 2 Press **REC** to start recording.
→ The disc will start playback automatically.

To select another track during recording

- 1 Press **PAUSE II** to interrupt recording.
- 2 Press **◀** or **▶** to select the desired track.
- 3 Press **PLAY ▶** to resume recording.

To stop recording

- Press **■**.
→ Recording and disc playback will stop simultaneously.

Dubbing Tapes

- 1 Load the prerecorded tape in tape deck 1.
 - You can set the tape to the desired passage where recording will start.
- 2 Press **DUBBING**.
→ Playing and recording will start simultaneously.
→ "DUB DUB" will be displayed.
- Dubbing of tapes is possible on one side of the tape only. To continue recording on the reverse side, at the end of side A, flip the tapes to side B and repeat the procedure.

To stop dubbing

- Press **■**.

Notes:

- Dubbing of tapes is possible only from tape deck 1 to tape deck 2.
- To ensure good dubbing, use tapes of the same length.
- You can listen to another source while dubbing.

External Sources

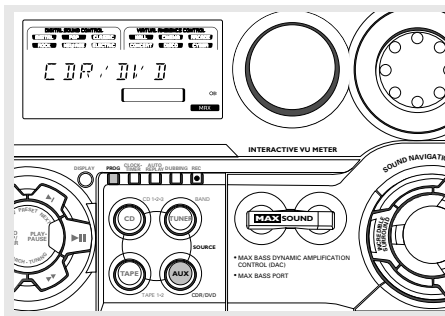

- If the sound from the external source is distorted, select CDR/DVD mode for listening.

Notes:

- You are advised not to listen to and record from the same source simultaneously.
- All the navigation sound control features (DSC or VAC for example) are available for selection.
- Refer to the operating instructions for the connected equipment for details.

For Recording, please refer to "Tape Operation/Recording".

Listening to External Sources

- 1 Connect the audio out terminals of the external equipment (TV, VCR, Laser Disc player, DVD player or CD Recorder) to the AUX/CDR IN terminals of your system.
- 2 Press **AUX** (CDR/DVD) repeatedly to select CDR/DVD mode or normal AUX mode.
→ "CDR/DVD" or "AUX" will be displayed.



Clock/Timer

English

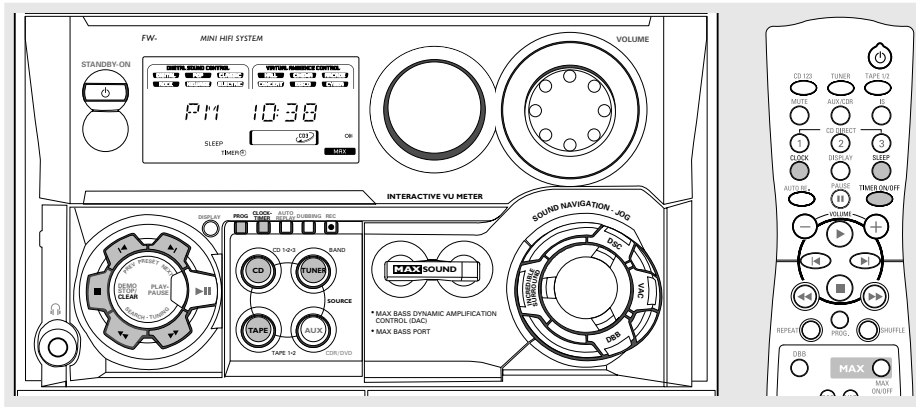

View Clock

The clock (if it is set) will be shown in Standby mode.

To view the clock in any source mode (CD or TUNER for example)

- Press **CLOCK•TIMER** (or **CLOCK** on the remote control).
 - The clock will be displayed for a few seconds.
 - If the clock has not been set, "----:--" will be displayed.

Clock Setting

The clock can be set in either 12-hour or 24-hour mode ("PM 12:00" or "00:00" for example)

- 1 Press **CLOCK•TIMER** twice.
- 2 Press **PROG** on the system repeatedly to select clock mode.
 - If 12-hour mode is selected, "PM 12:00" will start flashing.
 - If 24-hour mode is selected, "00:00" will start flashing.
- 3 Press **◀** or **▶** on the system repeatedly to set the hour.
- 4 Press **◀** or **▶** on the system repeatedly to set the minute.
- 5 Press **CLOCK•TIMER** again to store the setting.
 - The clock will start working.

To exit without storing the setting

- Press **■** on the system.

Notes:

- The clock setting will be cancelled when the power cord is disconnected or if a power failure occurs.
- During clock setting, if no button is pressed within 90 seconds, the system will exit clock setting mode automatically.

Timer Setting

The system can switch on to CD, TUNER, or TAPE 2 mode automatically at a preset time, serving as an alarm to wake you up.

IMPORTANT!

- Before setting the timer, ensure that the clock is set correctly.
- The timer will always be switched on after it has been set.
- The timer will not start if a recording is in progress.
- The volume of the timer will increase gradually from the minimum level to the last tuned volume level.

- 1 Press and hold **CLOCK•TIMER** for more than two seconds to select timer mode.
 - "PM 12:00" or "00:00" or the last timer setting will start flashing.
 - **TIMER** will start flashing.
 - The selected source will be lighted while other available sources are flashing.



Clock/Timer

- 2 Press **CD**, **TUNER** or **TAPE** to select the desired source.
 - Before setting the timer, make sure the music source has been prepared.
 - CD** – Load the disc(s). To start from a specific track, make a programme (refer to “CD Operation - Programming the disc tracks”).
 - TUNER** – tune to the desired radio station.
 - TAPE** – load the prerecorded tape into tape deck 2.
- 3 Press **◀** or **▶** on the system repeatedly to set the hour for the timer to start.
- 4 Press **⏪** or **⏩** on the system repeatedly to set the minute for the timer to start.
- 5 Press **CLOCK•TIMER** to store the start time.
 - "TIMER ON" will be displayed and followed by the set timer "XX:XX" and then the selected source.
 - **TIMER**  will remain on the display.
- At the preset time, the selected source will play.

To exit without storing the setting

- Press **■** on the system.

Notes:

- If CD is the selected source and it is not available when the preset time is reached, Tuner will be selected automatically.
- During timer setting, if no button is pressed within 90 seconds, the system will exit timer setting mode automatically.

To deactivate the TIMER

- Press **TIMER ON/OFF** on the remote control.
 - The display will show "CANCEL" and **TIMER**  will disappear from the display.

To activate the TIMER

- Press **TIMER ON/OFF** on the remote control.
 - The last set timer information will be shown for a few seconds and **TIMER**  will appear on the display.

Sleep Timer Setting

The sleep timer enables the system to switch to Standby mode automatically within a preset amount of time.

- 1 Press **SLEEP** on the remote control repeatedly to select a preset amount of time.
 - The selections are as follows (time in minutes):
15 → 30 → 45 → 60 → OFF → 15 ...
 - "SLEEP XX" or "OFF" will be displayed. "XX" is the time in minutes.
- 2 When you reach the desired length of time, stop pressing the **SLEEP** button.
 - **SLEEP** will appear on the display, except for "OFF" mode.
 - The Sleep Timer is now set. Before the system switches to standby mode, a countdown of 10 seconds will be displayed.
"SLEEP 10" → "SLEEP 9" ... → "SLEEP 1"
→ "SLEEP"

While SLEEP mode is activated

To check the remaining length of time

- Press **SLEEP** once.

To change the preset sleep timer

- Press **SLEEP** twice.
 - The display will show the remaining time followed by the sequence of sleep timer options.

To deactivate the Sleep Timer

- Press **SLEEP** repeatedly until "OFF" is displayed, or press the **STANDBY ON** button.





Specifications

AMPLIFIER

Output power	2000 W PMPO / 2 x 60 W RMS ⁽¹⁾
Signal-to-noise ratio	≥ 75 dBA (IEC)
Frequency response	50 – 20000 Hz, ± 3 dB
Input sensitivity	
AUX In / CDR/DVD In	500 mV / 1V
Output	
Speakers	≥ 6 Ω
Headphones	32 Ω – 1000 Ω
⁽¹⁾ (6 Ω, 1 kHz, 10% THD)	

CD PLAYER

Number of programmable tracks	40
Frequency response	20 – 20000 Hz
Signal-to-noise ratio	≥ 76 dBA
Channel separation	≥ 79 dB (1 kHz)
Total harmonic distortion	< 0.02% (1 kHz)

TUNER

FM wave range	87.5 – 108 MHz
MW wave range (9 kHz)	531 – 1602 kHz
MW wave range (10 kHz)	530 – 1700 kHz
Tuning grid	9/10 kHz
Number of presets	40
Antenna	
FM	75 Ω wire
AM	Loop antenna

TAPE PLAYER

Frequency response	
Normal tape (type I)	80 – 10000 Hz (8 dB)
Signal-to-noise ratio	
Normal tape (type I)	≥ 48 dBA
Wow and flutter	≤ 0.4% DIN

SPEAKERS

Front left/right

System	3-way; Bass reflex
Impedance	6 Ω
Woofer	1 x 5.25" full range
Tweeter	1 x 2"
Polydome Tweeter	1 x 1"
Dimensions (w x h x d) ..	240 x 310 x 290 (mm)
Weight	3.7 kg each

GENERAL

Material/finish	Polystyrene/Metal
AC Power	
For Version /21-21M ..	110 – 127 / 220 – 240 V;
.....	50/60 Hz Switchable
For Version /30	230 – 240 V; 50 Hz
Power Consumption	
Active	100 W
Standby	10 W
Dimensions (w x h x d) ..	265 x 310 x 390 (mm)
Weight (without speakers)	7.5 kg

Specifications and external appearance are subject to change without notice.



Maintenance

Cleaning the Cabinet

- Use a soft cloth slightly moistened with a mild detergent solution. Do not use a solution containing alcohol, spirits, ammonia or abrasives.

Cleaning Discs

- When a disc becomes dirty, clean it with a cleaning cloth. Wipe the disc from the centre out. Do not wipe in circular motion.
- Do not use solvents such as benzine, thinner, commercially available cleaners, or antistatic spray intended for analogue records.



Cleaning the disc lens

- After prolonged use, dirt or dust may accumulate at the disc lens. To ensure good playback quality, clean the disc lens with Philips CD Lens Cleaner or any commercially available cleaner. Follow the instructions supplied with cleaner.

Cleaning the Heads and the Tape Paths

- To ensure good recording and playback quality, clean the heads (A), the capstan(s) (B), and pressure roller(s) (C) after every 50 hours of tape operation.
- Use a cotton swab slightly moistened with cleaning fluid or alcohol.
- You also can clean the heads by playing a cleaning tape once.

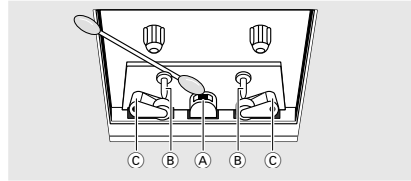

Demagnetising the heads

- Use a demagnetising tape available at your dealer.

Troubleshooting

WARNING

Under no circumstances should you try to repair the system yourself, as this will invalidate the warranty. Do not open the system as there is a risk of electric shock.

If a fault occurs, first check the points listed below before taking the system for repair. If you are unable to remedy a problem by following these hints, consult your dealer or service centre.

Problem	Solution
CD OPERATION	
"NO DISC" is displayed.	<ul style="list-style-type: none"> – Insert a disc. – Check if the disc is inserted upside down. – Wait until the moisture condensation at the lens has cleared. – Replace or clean the disc, see "Maintenance".
"DISC NOT FINALIZED" is displayed.	<ul style="list-style-type: none"> – Use a finalised CD-R(W) or CD-R.





Troubleshooting

RADIO RECEPTION

Radio reception is poor.

- If the signal is too weak, adjust the antenna or connect an external antenna for better reception.
- Increase the distance between the Mini HiFi System and your TV or VCR.

TAPE OPERATION/RECORDING

Recording or playback cannot be made.

- Clean deck parts, see "Maintenance".
- Use only NORMAL (IEC I) tape.
- Apply a piece of adhesive tape over the missing tab space.

The tape deck door cannot open.

- Remove and reconnect the AC power plug and switch on the system again.

GENERAL

The system does not react when buttons are pressed.

- Remove and reconnect the AC power plug and switch on the system again.

Sound cannot be heard or is of poor quality.

- Adjust the volume.
- Disconnect the headphones.
- Check that the speakers are connected correctly.
- Check if the stripped speaker wire is clamped.

The left and right sound outputs are reversed.

- Check the speaker connections and location.

The remote control does not function properly.

- Select the source (CD or TUNER, for example) before pressing the function button (▶, ◀, ▶).
- Reduce the distance between the remote control and the system.
- Insert the batteries with their polarities (+/- signs) aligned as indicated.
- Replace the batteries.
- Point the remote control directly toward IR sensor on the front of the system.

The timer is not working.

- Set the clock correctly.
- Press TIMER ON/OFF to switch on the timer.
- If a recording is in progress, stop the recording.

Not all lighted buttons are showing light.

- Press DISPLAY to select NORMAL or MODE 1 display mode.

The Clock/Timer setting is erased.

- Power has been interrupted or the power cord has been disconnected. Reset the clock/timer.

The system displays features automatically and buttons start flashing.

- Press and hold DEMO STOP ■ on the system to switch off the demonstration.