



PHILIPS

FW- C39
C38
Mini Hi-Fi Systems



PHILIPS

Let's make things better.





English

Français

Español

中文

México

NOM-135-NVCE

Es necesario que lea cuidadosamente su instructivo de manejo.

	PRECAUCIÓN - ADVERTENCIA	
	No abrir, riesgo de choque eléctrico	
	ATENCIÓN	
	Verifique que el voltaje de alimentación sea el requerido para su aparato	
Para evitar el riesgo de choque eléctrico, no quite la tapa. En caso de requerir servicio, dirijase al personal calificado.		

Descripción: **Minisistema de Audio**
 Modelo: **FW-C38/21 & FW-C39/21**
 Alimentación: **110-127/220-240 V; ~50-60 Hz**
 Consumo: **75 W**
 Importador: **Philips Mexicana, S.A. de C.V.**
 Domicilio: **Norte 45, #669, Col. Industrial Vallejo**
 Localidad y Telefono: **C.P. 02300 México D.F., Tel. 728 42 00**
 Exportador: **Philips Hong Kong**
 País de Origen: **China**

Nº de Serie: _____

LEA CUIDADOSAMENTE ESTE INSTRUCTIVO ANTES DE USAR SU APARATO.



English	4	English
Français	25	Français
Español	47	Español
中文	69	中文
Warranty	89	
<small>Australia/New Zealand/Mexico</small>		



**CLASS 1
LASER PRODUCT**



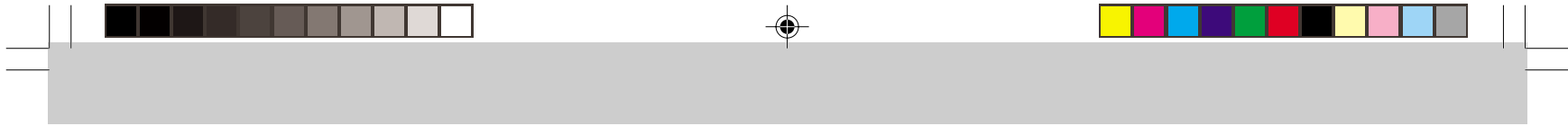

English

FW - C39



FW - C38



CONTENTS

General Information	5
Safety Information	5
Preparation	6 - 7
Controls	8 - 9
Operating The System	10 - 12
CD	12 - 15
Tuner	16 - 17
Tape	17- 18
AUX	18
Karaoke	18
Recording	19 - 20
Clock	20
Timer	21
Sleep Timer	21
Specifications	22
Maintenance	23
Troubleshooting	23 - 24

GENERAL INFORMATION

IMPORTANT:
PLEASE NOTE THAT THE
VOLTAGE SELECTOR
LOCATED AT THE REAR OF
THIS SYSTEM IS PRESET AT
220V FROM THE FACTORY.
FOR COUNTRIES THAT
OPERATE AT 110V, PLEASE
ADJUST TO 110V BEFORE YOU
SWITCH ON THE SYSTEM.

General Information

- **The type plate (which contains the serial number) is located at the rear of the system.**
- **Recording is permissible if copyright or other rights of third parties are not infringed.**

Environmental Information

All unnecessary packaging has been omitted. We have tried to make the packaging easy to separate into three materials: cardboard (box), polystyrene foam (buffer) and polyethylene (bags, protective foam sheet).

Your system consists of materials which can be recycled and reused if disassembled by a specialized company. Please observe the local regulations regarding the disposal of packaging materials, exhausted batteries and old equipment.

SAFETY INFORMATION

Accessories (Supplied)

- Remote control
- Batteries (two AA size) for remote control
- AM loop antenna
- FM wire antenna
- AC power cord
- SS-39 Surround Speakers
(for model FW-C39 only)

Safety Information

- Before operating the system, check that the operating voltage indicated on the typeplate (or the voltage indication beside the voltage selector) of your system is identical with the voltage of your local power supply. If not, please consult your dealer. The typeplate is located at the rear of your system.
- When the system is switched on, do not move it around.
- Place the system on a solid base (e.g. a cabinet).
- Place the system in a location with adequate ventilation to prevent internal heat build-up in your system. Allow at least 10cm clearance from the rear and the top of the unit and 5cm from each side.

- Do not expose the system to excessive moisture, rain, sand or heat sources.
- Under no circumstances should you repair the system yourself, as this will invalidate the warranty!
- If the system is brought directly from a cold to a warm location, or is placed in a very damp room, moisture may condense on the lens of the CD unit inside the system. Should this occur, the CD player will not operate normally. Leave the power on for about one hour with no disc in the system until normal playback is possible.
- Electrostatic discharge may cause unexpected problems. See whether these problems disappear if you unplug the AC power cord and plug it in again after a few seconds.
- **To disconnect the system from the power supply completely, remove the AC power plug from the wall socket.**

English

PREPARATION

English

Rear Connections

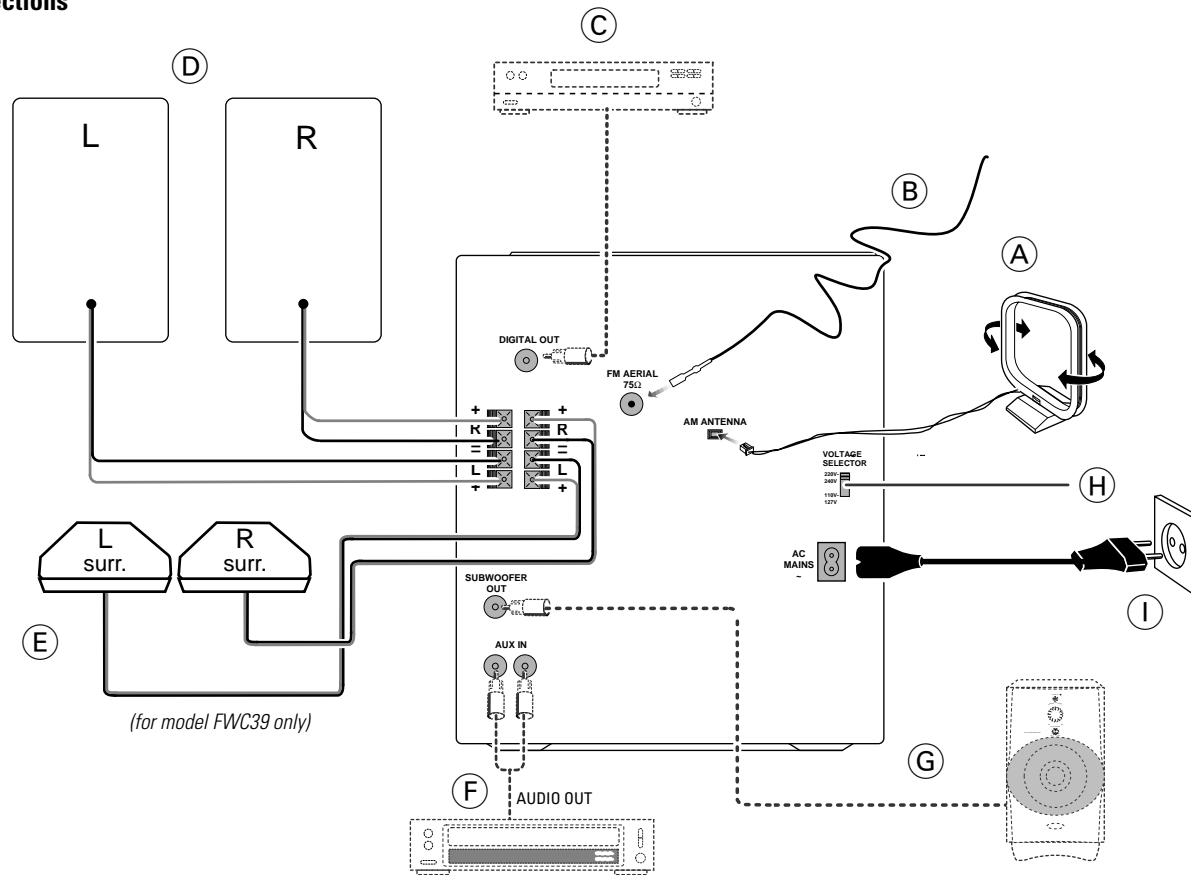

(for model FWC39 only)

PREPARATION

English

A AM Loop Antenna Connection

Connect the supplied loop antenna to the AM ANTENNA terminal. Place the AM loop antenna far away from the system and adjust its position for the best reception.

B FM Wire Antenna Connection

Connect the supplied FM wire antenna to the FM AERIAL (FM ANTENNA) 75 Ω terminal. Adjust the position of the FM antenna for the best reception.

Outdoor Antenna

For better FM stereo reception, connect an outdoor FM antenna to the FM AERIAL (FM ANTENNA) 75 Ω terminal using a 75 Ω coaxial wire.

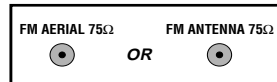

C Digital Out Connection

You can record the digital sound from the CD, through this output, on any audio equipment with digital input (e.g. CD Recorder, Digital Audio Tape (DAT) deck, Digital to Analog Converter and Digital Signal Processor).

Connect one end of the cinch cable (not supplied) to the DIGITAL OUT socket and the other end to the audio equipment with digital input. When connecting the cinch cable, make sure it is fully inserted.

D Speakers Connection

- Connect the right speaker to Front terminal R, with the colored wire to + and the black wire to -.
- Connect the left speaker to Front terminal L, with the colored wire to + and the black wire to -.
- Clip the stripped portion of the speaker wire as shown.

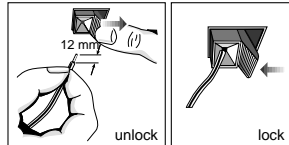

E Rear Surround Speakers' Connection (for models FW-C39 only)

Connect the black (non-marked) wires to the black REAR SURROUND terminals and the colored (marked) wires to the grey REAR SURROUND terminals.

F Connecting other equipment to your system

You can connect the audio left and right OUT terminals of a TV, VCR, Laser Disc player, DVD player or CD Recorder to the AUX IN terminals at the rear of the system.

G Subwoofer Out Connection

Connect the optional active subwoofer to the SUBWOOFER OUT terminal. The subwoofer reproduces just the low bass sound effect (e.g. explosions, the rumble of spaceships, etc.). Be sure to follow the instructions supplied with the subwoofer.

H Adjusting the Operating Voltage

(not available for version /30)

Before connecting the AC power cord to the wall outlet, make sure that the voltage selector at the rear of the system is set to the local power line voltage. If not, reset the selector before connecting to the wall outlet.

I AC Power Supply

After all other connections have been made, connect the AC power cord to the system and to the wall outlet.

Inserting batteries into the Remote Control

- Insert the batteries (Type R06 or AA) into the remote control as shown in the battery compartment.

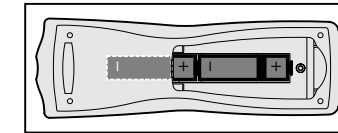

- To avoid damage from possible battery leakage, remove dead batteries or batteries that will not be used for a long time. For replacement, use type R06 or AA batteries.

Notes for remote control:

- First select the source you wish to control by pressing one of the source select keys on the remote control (e.g. CD, TUNER, etc.).
- Then select the desired function (▶, ◀, ▶|, etc.).

CONTROLS

English

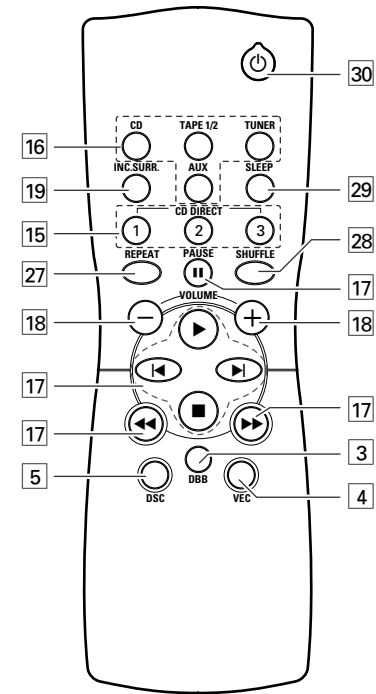
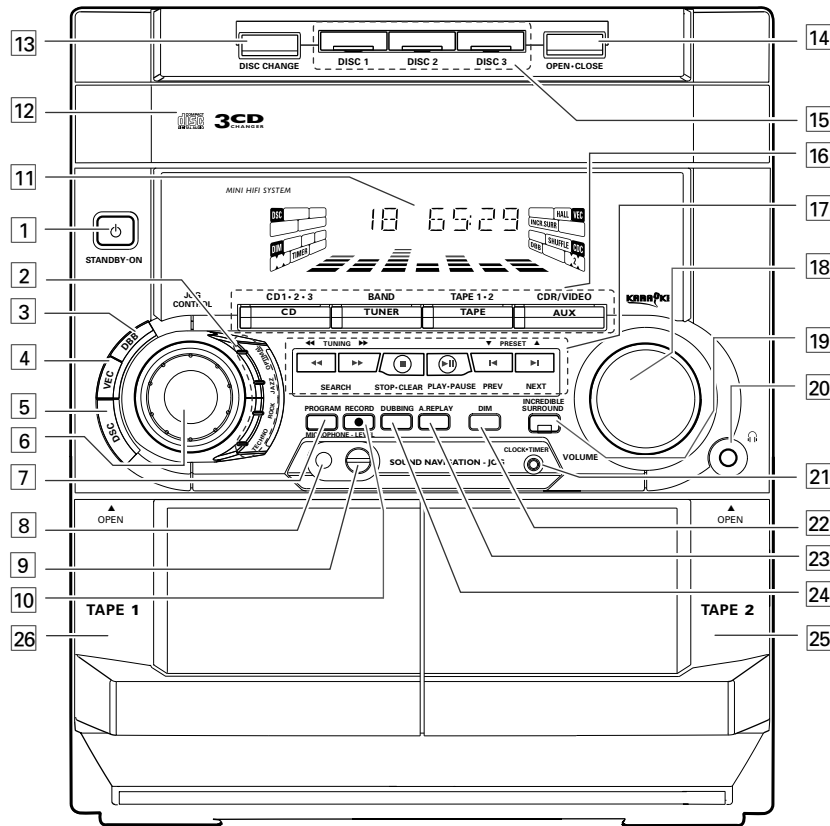



CONTROLS

English

Controls on the system and remote control

1 **STANDBY ON**

- to switch the system on or to standby mode.
- to use for EASY SET.

2 **DIGITAL SOUND CONTROL DISPLAY PANEL**

- to view the desired DSC display.

3 **DBB (DYNAMIC BASS BOOST)**

- to switch on bass boost, to enhance bass response or to switch off bass boost.

4 **VEC**

- to select the desired Virtual Environment Control effect : HALL, CINEMA or CONCERT.

5 **DSC**

- to select the desired sound effect : OPTIMAL, JAZZ, ROCK or TECHNO.

6 **JOG CONTROL**

- to select the desired DSC setting. You must select the DSC feature first.
- to select the desired VEC setting. You must select the VEC feature first.

7 **PROGRAM**

- for CD to program CD tracks.
- for TUNER to program preset radio stations.
- for CLOCK to select 12- or 24-hour in clock setting mode.

8 **MICROPHONE** *(not available for version /30)*

- to connect microphones jack.

9 **MIC LEVEL** *(not available for version /30)*

- to adjust the mixing level for karaoke or microphone recording.

10 **RECORD**

- to start recording on tape deck 2 only.

11 **DISPLAY SCREEN**

- to view the current setting of the system.

12 **CD CAROUSEL TRAY**

13 **DISC CHANGE**

- to change CD(s).

14 **OPEN•CLOSE**

- to open or close the CD carousel tray.

15 **DISC 1 / DISC 2 / DISC 3 (CD DIRECT PLAY)**

- to select a CD tray for playback.

16 **SOURCE** – to select the following:

- CD / (CD 1•2•3)**
- to select CD mode. When CD playback is stopped, press to select disc tray 1, 2 or 3.

TUNER / (BAND)

- to select Tuner mode. When in tuner mode, press to select the waveband: FM or MW.

TAPE / (TAPE 1•2)

- to select Tape mode. When tape playback is stopped, press to select either tape deck 1 or 2.

AUX (CDR/VIDEO)

- to select sound from an external source (e.g. TV, VCR, Laser Disc player, DVD player or CD Recorder).

17 **MODE SELECTION**

SEARCH ◀▶ (TUNING ◀▶▶)

- for CD to search backward/forward.

- for TUNER to tune to a lower or higher radio frequency.

- for TAPE to rewind or fast forward on tape.

- for CLOCK to set the hour *(on the system only)*.

STOP•CLEAR ■

- for CD to stop CD playback or to clear a program.

- for TUNER to stop programming.

- for TAPE to stop playback or recording.

- for DEMO *(on the system only)* to start or stop demonstration mode.

PLAY ▶ / PAUSE II

- for CD to start or interrupt playback.

- for TAPE to start playback.

- PREV ◀ / NEXT ▶ (PRESET ▼▲)**
- for CD to skip to the beginning of the current, previous, or next track.

- for TUNER to select a preset station in memory.

- for CLOCK to set the minute *(on the system only)*.

18 **VOLUME**

- to increase or decrease the volume.

19 **INCREDIBLE SURROUND**

- to switch on or off the surround sound effect.

20

- to connect headphones.

21 **CLOCK•TIMER**

- to view the clock, set the clock or set the timer.

22 **DIM**

- to select different brightness for the display screen : DIM 1, DIM 2, DIM 3 or DIM OFF.

23 **AUTO REPLAY**

- to select playback mode either in continuous AUTO REPLAY or ONCE only.

24 **DUBBING**

- to dub a tape in normal speed.

25 **TAPE DECK 2**

26 **TAPE DECK 1**

27 **REPEAT**

- to repeat a CD track, a disc, or all available discs.

28 **SHUFFLE**

- to play all the available discs and their tracks in random order.

29 **SLEEP**

- to switch the system to standby mode at a selected time.

30

- to switch the system to standby mode.

OPERATING THE SYSTEM

English

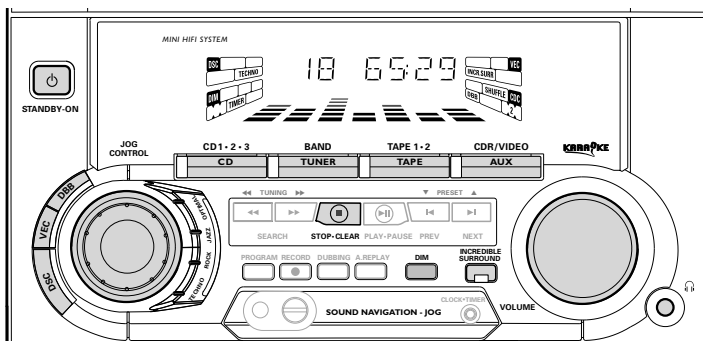

Important:
Before you operate the system, complete the preparation procedures.

Demonstration mode

The system has a demonstration mode that shows the various features offered by the system. **When the system is switched on for the first time, the demonstration mode will start automatically.**

Notes:

- During the demonstration, if you press any source (or standby-on) button, the system will switch to the respective mode (or standby).
- When the system is switched to standby mode, the demonstration will resume 5 seconds later.

To stop the demonstration mode

- Press and hold **■** (on the system only) for **5 seconds** when the system is in demonstration mode.
 - The demonstration will stop.
 - "DEMO OFF" is displayed.
 - The system will switch to standby mode.

Note:

- Even though the AC power cord is removed from and reconnected to the wall socket, the demonstration will remain off until it is switched on again.

To start the demonstration mode

- Press and hold **■** (on the system only) for **5 seconds** when the system is in standby mode.
 - The demonstration will begin.

Easy Set

EASY SET allows you to store all available radio stations automatically.

- Press and hold **STANDBY ON** (on the system only) for **5 seconds** when the system is in standby or demonstration mode.
 - "EASY SET" will be displayed, and followed by "TUNER" and then "AUTO".
 - EASY SET will start searching for all radio on FM band and then followed by radio stations on MW band.
 - All available radio stations with sufficient signal strength will be stored. Up to 40 presets may be stored.

Notes:

- EASY SET will start with the FM band, if there are still presets available, the system will continue to store the MW band.
- When EASY SET is used, all previously stored radio stations will be replaced.
- The last preset radio station will appear on the display when EASY SET is completed.

Switching the system ON

- Press **CD, TUNER, TAPE** or **AUX**.

You can also switch on the system by pressing any one of the CD DIRECT PLAY buttons.

Switching the system to standby mode

- Press **STANDBY ON** or **⏻** on the remote control.
 - The system will switch to standby mode.

Selecting the Source

- Press the respective source selection button: **CD, TUNER, TAPE** or **AUX**.
 - The display indicates the selected source.

Note:

- For an external source, make sure you have connected the audio left and right OUT terminals of the external equipment (TV, VCR, Laser Disc player, DVD player or CD Recorder) to the AUX IN terminals.



OPERATING THE SYSTEM

English

DIM mode

You can select the desired brightness for the display.

- Press **DIM** to select DIM 1, DIM 2, DIM 3 or DIM OFF display mode.
 - The **DIM** appear on the display.
 - "DIM 1", "DIM 2", "DIM 3" or "DIM OFF" will be displayed depending on the mode selected.

DIM OFF - normal brightness with Spectrum Analyzer On



DIM 1 - normal brightness with Spectrum Analyzer Off

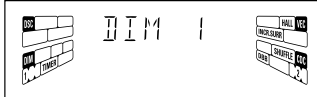

DIM 2 - half brightness with Spectrum Analyzer On



DIM 3 - half brightness with Spectrum Analyzer Off and all LEDs on the system will be switched off.

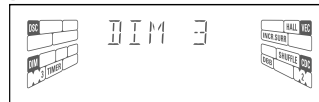

Sound Control

VOLUME ADJUSTMENT

Adjust **VOLUME** to increase or decrease the sound level.

For Personal Listening

Connect the headphones plug to the socket at the front of the system. The speakers will be muted.

DIGITAL SOUND CONTROL (DSC)

The DSC feature enables you to enjoy special sound effects that have preset equalizer settings, providing the best music reproduction.

- 1 Press to select the **DSC** feature.
- 2 Adjust **JOG CONTROL** to select OPTIMAL, JAZZ, ROCK or TECHNO.
 - The Digital Sound Control display panel will light up respectively.
 - "OPTIMAL", "JAZZ", "ROCK" or "TECHNO" and the respective flag will be displayed.

Note:

- When "OPTIMAL" sound is selected, **DBB** will be switched on automatically.

DYNAMIC BASS BOOST (DBB)

The DBB mode enhances the bass response.

- Press **DBB** to switch on bass response.
 - The DBB button lights up.
 - "DBB ON" and the DBB flag will be displayed.

To switch off DBB

- Press **DBB** again.
 - The DBB button light is switched off.
 - "DBB OFF" will be displayed.
 - The DBB flag disappear from the display.

Note:

- Some CDs or tapes might be recorded in high modulation, which causes a distortion at high volume. If this occurs, switch off DBB or reduce the volume.

VIRTUAL ENVIRONMENT CONTROL (VEC)

The VEC feature enables you to adjust the system to select a type of environment.

- 1 Press to select the **VEC** feature.
- 2 Adjust the **JOG CONTROL** to select the desired Virtual Environment Control setting : HALL, CINEMA or CONCERT.
 - "HALL", "CINEMA" or "CONCERT" and the respective flag will be displayed.

VEC Selection	DBB	IS
HALL	On	On
CONCERT	Off	On
CINEMA	Off	On

OPERATING THE SYSTEM

English

Incredible Surround

Normal stereo sound is determined by the distance between the front speakers. When Incredible Surround is switched on, it magnifies the virtual distance between the front speakers for an incredibly wide, enveloping, stereo effect.

- Press **INCREDIBLE SURROUND** to switch on.
 - The INCREDIBLE SURROUND button lights up.
 - "INC SURR" and the INCR. SURR flag will be displayed.

To switch off Incredible Surround

- Press **INCREDIBLE SURROUND** again.
 - The INCREDIBLE SURROUND button light is switched off.
 - "IS OFF" will be displayed.
 - The INCR. SURR flag disappear from the display.

CD

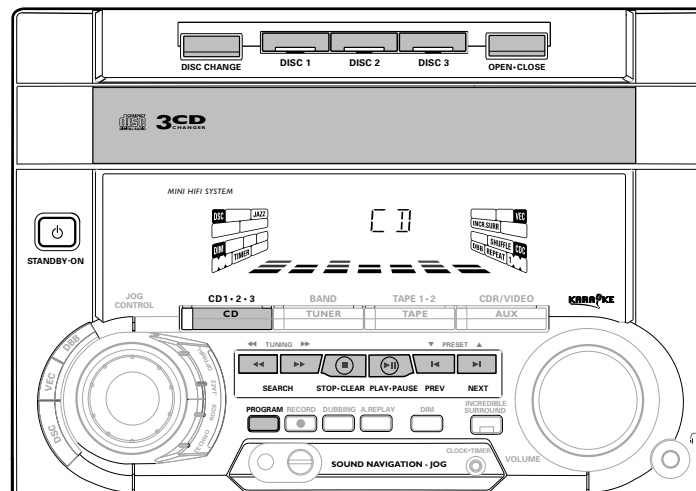

Warning!

- 1) *This system is designed for conventional CDs. Do not use any accessories such as disc stabilizer rings or CD treatment sheets, etc., which may damage the CD mechanism.*
- 2) *Do not load more than one disc into each tray.*
- 3) *When the CD changer is loaded with CDs, do not turn over or shake the system. This may jam the changer.*

You may load three discs in the CD changer for continuous playback without interruption.



CD

Discs for playback

This system can play all digital audio CD, finalized digital audio CD-Recordable and finalized digital audio CD-Rewritable format discs.



Loading the CD Changer

- 1 Press **CD** to select CD mode.
- 2 Press **OPEN•CLOSE**.
→ The CD carousel tray slides out.
- 3 Load a CD with the printed side up in the right tray.
 - You can load another disc in the left tray.
 - To load the third disc, press the **DISC CHANGE** button.
→ The CD carousel tray will rotate until the empty tray is ready for loading.
- 4 Press **OPEN•CLOSE** to close the CD carousel tray.
→ The total number of tracks and the playing time of the selected disc appear on the display.

Note:

- To ensure good system performance, wait until the CD changer completely reads the disc(s) before proceeding.

CD Direct Play

- You can play a CD directly by pressing the **DISC 1**, **DISC 2** or **DISC 3** button. The CD player will stop at the end of playback of the selected disc.
 - A lit button indicates that a disc is loaded in the disc tray.
 - A flashing button indicates that a disc is playing.

Playing a CD

- 1 Press **▶** to start playback.
 - The disc tray, track number and elapsed playing time of the current track appear on the display.
- To interrupt playback, press **||**.
→ The playing time flashes.
- To resume playback, press **▶** again.
- 2 To stop playback, press **■**.

Note:

- All the available discs will play once, then stop.

Disc Change

You can change the outer two discs while the third inner disc is stopped or is playing.

- 1 Press **DISC CHANGE**.
→ The CD carousel tray slides out.
- 2 Replace the discs in the left and right disc trays.
 - If you press **DISC CHANGE** again during playback, the CD will stop playing.
→ The CD carousel tray will rotate until the inner tray is rotated out and is ready for changing.
- 3 Press **OPEN•CLOSE** to close the CD carousel tray.

Selecting a desired track

Selecting a desired track when playback is stopped

- 1 Press **◀** or **▶** until the desired track appears on the display.
- 2 Press **▶** to start playback.
→ The selected track number and elapsed playing time appear on the display.

Selecting a desired track during playback

- Press **◀** or **▶** until the desired track appears on the display.
→ The selected track number and elapsed playing time appear on the display.
- If you press **◀** once it will skip to the beginning of the current track and play the track again.

Note:

- Pressing **◀** during shuffling can only skip to the beginning of the current track.

Searching for a particular passage during playback

- Press and hold **◀◀** or **▶▶** until the desired passage is located.
→ The volume will be reduced.
- Play returns to normal when **◀◀** or **▶▶** is released.

English



CD

English

Programming Tracks

Programming tracks of a loaded CD is possible when playback is stopped. The display will indicate the total tracks stored in the program. Up to 40 tracks can be stored in the memory in any order. When 40 tracks are stored and you attempt to store another track, the display will show "PROGRAM FULL".

- 1 Load the desired discs in the disc trays.
- 2 Press **PROGRAM** to start programming.
 - The **PROG** flag starts flashing.
 - It will cancel any previously selected repeat mode.
- 3 Press the **CD** (CD 1•2•3) or **DISC 1/2/3** button to select the disc.
- 4 Press **◀** or **▶** to select the desired track.
- 5 Press **PROGRAM** to store the track.
 - Repeat steps **3** to **5** to store other discs and tracks.
- 6 Press **■** once to end programming.
 - The total number of tracks programmed and total playing time appear on the display.

Notes:

- If the total playing time is more than "99:59" or if one of the programmed tracks has a number greater than 30, then "--:--" appears on the display instead of the total playing time.

- If the system is reading the discs, programming is not possible, "READING" will be displayed and followed by "DISC X". "X" is the current read disc number.
- During programming, if no button is pressed within 20 seconds, the system will exit program mode automatically.

Reviewing the program

Reviewing of the program is possible only when playback is stopped.

- Press **◀** or **▶** repeatedly to review the programmed tracks.
- Press **■** to exit review mode.

Playing the program

- 1 Press **▶** to start program playback.
 - "PLAY PROGRAM" will be displayed.
 - The track number and elapsed playing time of the current track will appear on the display.
- If you press **REPEAT** during program playback, the current track or all programmed tracks will be played repeatedly.
 - "TRACK" or "PROGRAM" will be displayed.
 - The **REPEAT** and **PROG** flags appear on the display.
- 2 Press **■** to stop program playback.

Notes:

- If you press any of the CD **DIRECT PLAY** buttons, the system will play the selected disc or track and the stored program will be ignored temporarily. The **PROG** display also will disappear temporarily from the display. It will reappear when playback of the selected disc ends.
- **REPEAT DISC** mode will be cancelled when program playback begins.

Erasing the program (when playback is stopped)

- Press **■**.
 - "PROGRAM CLEARED" will be displayed.

Note:

- The program will be erased when the system is disconnected from the power supply or when the CD carousel tray is opened.

Shuffle (only on remote control)

In shuffle mode, the system plays all the available discs and their tracks in random order. Shuffle may be used also when tracks are programmed.

To shuffle all the discs and tracks

- 1 Press **SHUFFLE**.
 - "SHUFFLE" will be displayed.
 - The **SHUFFLE** flag, the disc and the track selected at random appear on the display.
- The discs and the tracks will be played in random order until you press **■**.
- If you press **REPEAT** during shuffling, the current track or all available discs will be played repeatedly.
 - "TRACK" or "ALL DISC" will be displayed.
 - The **REPEAT** and **SHUFFLE** flags appear on the display.
- 2 Press **SHUFFLE** again to resume normal playback.
 - The **SHUFFLE** flag disappears from the display.

Note:

- **REPEAT DISC** mode will be cancelled when shuffle is selected.

CD

Repeat (only on remote control)

You can play the current track, a disc or all available discs repeatedly.

- 1 Press **REPEAT** on the remote control to select the various repeat modes.
 - "TRACK", "DISC", "ALL DISC" or "OFF" will be displayed.
 - The REPEAT flag appears on the display.
- The selected track, selected disc or all available discs will now be played repeatedly until you press ■.
- 2 Press **REPEAT** until the "OFF" mode is displayed to resume normal playback.
 - The REPEAT flag disappears from the display.

Notes:

- REPEAT DISC mode is not available during program play or shuffle mode.
- You can also repeat shuffling a program.
 - "TRACK" or "PROGRAM" will be displayed.
 - The REPEAT, PROG, and SHUFFLE flags appear on the display.

TUNER

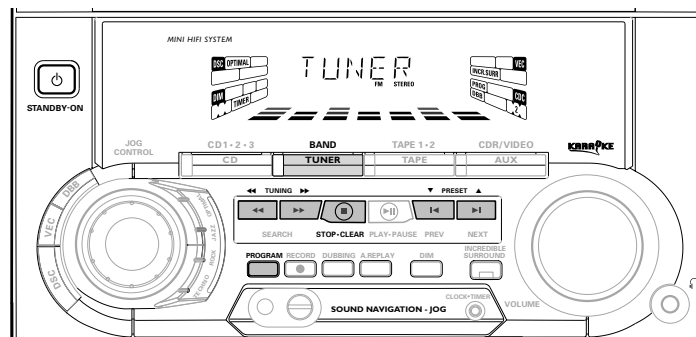

Note:

- For 'EASY SET' feature, please refer to page 10.

Tuning to radio stations

- 1 Press **TUNER (BAND)** to select TUNER mode.
 - "TUNER" will be displayed.
 - A few seconds later, the current radio frequency will be displayed.
 - 2 Press **TUNER (BAND)** again to select the desired waveband : FM or MW.
 - 3 Press **◀◀** or **▶▶** for more than one second, then release.
 - The display will show "SEARCH" until a radio station with sufficient signal strength is found.
- Repeat this procedure until the desired station is reached.

- To tune to a weak station, briefly press **◀◀** or **▶▶** repeatedly until the display shows the desired frequency and/or when the best reception has been obtained.

Storing Preset Stations

You can store up to 40 radio stations in the memory. When a preset radio station is selected, the preset number appears next to the frequency on the display.

English

TUNER

English

Automatic programming

- 1 Press **TUNER** (BAND).
- 2 Press **PROGRAM** for more than one second.
 - The PROG flag starts flashing and "AUTO" will be displayed.
 - The system will search for every available station in the FM waveband first, then search the MW waveband.
 - All available stations will be stored automatically. The frequency and preset number will be displayed briefly.
 - The system will stop searching when all the available radio stations are stored or when the memory for 40 preset radio stations is used.
 - The system will remain tuned to the last stored preset radio station.

Notes:

- You can cancel the automatic programming by pressing **PROGRAM** or **■** (on the system only).
- If you want to reserve a section of preset numbers, for example preset numbers 1 to 9, select preset 10 before starting automatic programming, only the preset numbers 10 to 40 will be programmed.

Manual programming

- 1 Press **TUNER** (BAND).
- 2 Press **TUNER** (BAND) again to select the desired waveband : FM or MW.
- 3 Press **PROGRAM** for less than one second.
 - The PROG flag starts flashing.
 - The next available preset number will be displayed for selection.
- 4 Press **◀** or **▶** to tune to the desired frequency.
 - If you wish to store the radio station to another preset number, press **▼** or **▲** to select the desired preset number.
- 5 Press **PROGRAM** again.
 - The PROG flag disappears and the radio station will be stored.
 - Repeat **steps 3 – 5** to store other preset radio stations.

Notes:

- When 40 radio stations are stored and you attempt to store another radio station, the display will show "PROGRAM FULL". If you want to change an existing preset number, repeat steps 3 – 5.
- You can cancel manual programming by pressing **■** (on the system only).
- During programming, if no button is pressed within 20 seconds, the system will exit program mode automatically.

Tuning to Preset Radio Stations

- Press **▼** or **▲** to select the desired preset number.
 - The preset number, radio frequency, and waveband appear on the display.

Changing the MW tuning grid

(not available for version /30)

The frequency step can be changed if necessary. In North and South America, the frequency step between adjacent channels in the MW band is 10 kHz. In other parts of the world, it is 9 kHz. The frequency step preset in the factory is 9 KHz.

For MW Band

To change from 9 kHz to 10 kHz or vice versa

Changing of tuning grid will erase all previously stored preset stations.

- 1 Disconnect the system from the AC power supply (pull out the AC power cord).
- 2 Press and hold **TUNER** and **TUNING ▶▶** while reconnecting the system to the AC power supply.
 - Display will show "GRID 10" or "GRID 9".

Notes:

- GRID 9 indicates that the tuning grid is in step of 9 kHz in MW band. GRID 10 indicates that the tuning grid is in step of 10 kHz in MW band.
- FM tuning grid will also be changed from 50 kHz to 100 kHz or vice versa. All preset stations will also be erased.

TAPE

English

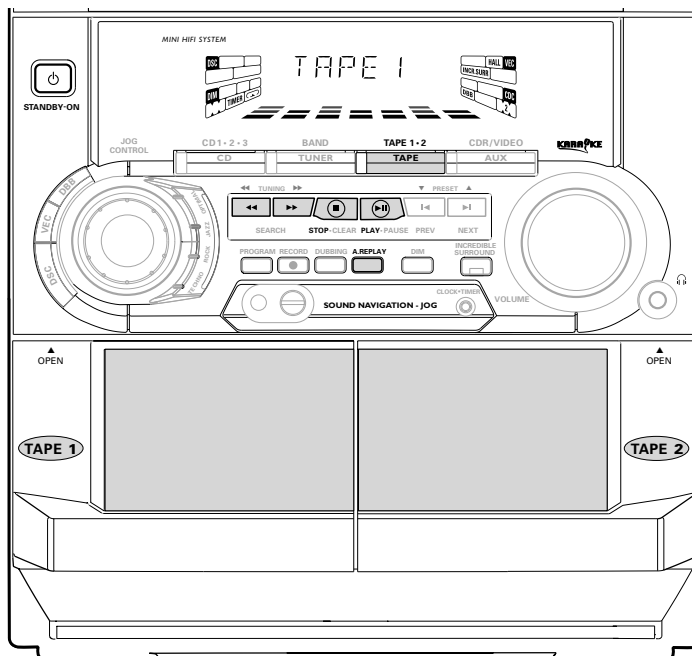

Loading a tape

- 1 Press **OPEN**.
- 2 The tape deck door opens.
- 3 Load the tape with the open side downward and the full spool to the left.

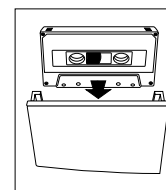

- 4 Close the tape deck door.

Auto Replay

- Press **A. REPLAY** to select either continuous AUTO REPLAY or ONCE during tape playback.
 - "AUTO REPLAY" (☐) or "ONCE" (⏮) will be displayed.

Notes:

- This feature is available during tape playback only.
- When "AUTO REPLAY" is selected, the tape will rewind automatically at the end of playback for the selected side. Then it will start playing again. It will replay up to a maximum of 20 times until you press **■**.
- When "ONCE" is selected, the tape will play the selected side once and then stop.

Tape Playback

- 1 Press **TAPE** (TAPE 1•2) to select TAPE mode.
 - "TAPE 1" or "TAPE 2" will be displayed and followed by "T 1 >>>" or "T2 >>>".
- 2 Load the tape into the selected tape deck.
- 3 Press **▶** to start playback.
 - "T 1" or "T2" with ">" scrolling right will be displayed.
 - Press **A.REPLAY** to select the different type of playback mode (see Auto Replay).
- 4 Press **■** to end playback.
 - "T 1" or "T2" with ">>>" will be displayed.

Rewind/Fast Forward

When playback is stopped

- 1 You can rewind or fast forward the tape by pressing **◀** or **▶** respectively.
 - If rewinding, "T 1 <" or "T2 <" with "<" scrolling left will be displayed.
 - If fast forwarding, "T 1 >" or "T2 >" with ">" scrolling right will be displayed.
 - The tape will stop automatically at the end of rewinding or fast forwarding.
- 2 Press **■** to stop rewinding or fast forwarding.

TAPE

AUX

KARAOKE

English

During playback

- Press and hold ◀◀ or ▶▶ until the desired passage is located.
→ "T 1 or T 2" with "<<< or >>>" scrolling left or right will be displayed depending on which button is pressed.
- During searching, the sound is reduced to a low volume.
- When you release ◀◀ or ▶▶, the tape continues playing.

Notes:

- During rewinding or fast forwarding of a tape, it is also possible to select another source (e.g. CD, TUNER, or AUX).
- Before playing a tape, check and tighten slack tape with a pencil. Slack tape may get jammed or may burst in the mechanism.
- C-120 tape is extremely thin and is easily deformed or damaged. It is not recommended for use in this system.
- Store the tapes at room temperature and do not put them too close to a magnetic field (for example, a transformer, TV, or speaker).

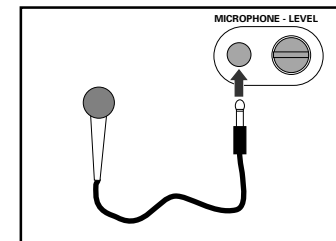
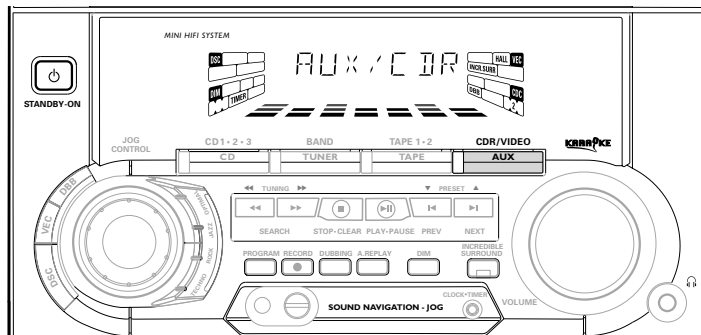

Selecting External Equipment

If you have connected the audio out terminals of the external equipment (TV, VCR, Laser Disc player, DVD player or CD Recorder) to the AUX IN terminals, you can hear the enhanced sound from the system.

- Press **AUX (CDR/VIDEO)** to select the external equipment.
→ "AUX / CD" will be displayed.

Note:

- All the sound control features (e.g. DSC, DBB, etc.) are available for selection.

Microphone Mixing (not available for version /30)

- 1 Set the **MIC LEVEL** control to the minimum level to prevent acoustic feedback (e.g. a loud howling sound) before you connect the microphone.
- 2 Connect a microphone to the **MICROPHONE** socket.
- 3 Press **CD, TUNER, TAPE** or **AUX**.
- 4 Play the selected source.
- 5 Adjust the volume level with **VOLUME** control.
- 6 Adjust the **MIC LEVEL** control to the mixing level that you want.
- 7 Start singing or talking through the microphone.

Note:

- Keep the mic away from the speakers to prevent howling

RECORDING

English

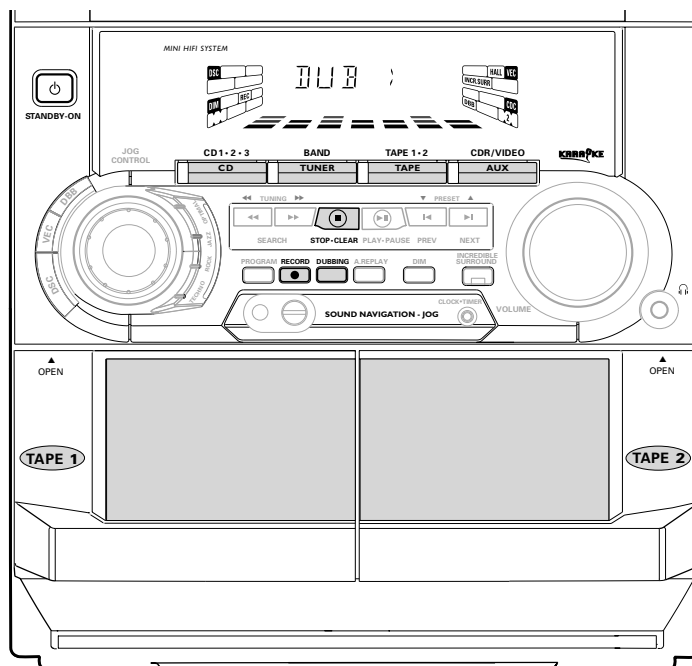

Notes:

- If you do not intend to record via the microphone, unplug the microphone to avoid accidental mixing with other recording source.
- For recording, use only tape of IEC type I (normal tape) or IEC type II (CrO₂).
- The tape is secured at both ends with leader tape. At the beginning and end of tape, nothing will be recorded for six to seven seconds.
- The recording level is set automatically, regardless of the position of VOLUME, DBB, Incredible Surround, DSC or VEC.
- To prevent accidental recording, break out the tab on the left shoulder of the tape side that you want to protect.
- If "CHECK TAPE" is displayed, the protection tab has been broken. Put a piece of clear adhesive tape over the opening. Do not cover the CrO₂ tape detection hole when covering the tab opening.

Recording the mixed sound / One Touch Recording

- During microphone mixing, you can record the mixed sound on a tape in tape deck 2 except dubbing mode.
- For One Touch Recording, as soon as you press RECORD, the current source (CD, TUNER or AUX) will be recorded on tape deck 2.

- 1 Load a blank tape in tape deck 2.
- 2 Press **RECORD** to start recording.
→ The REC flag starts flashing.
- 3 Press **■** to stop recording.

Note:

- When you press RECORD while in TAPE mode, "SELECT SOURCE" will be displayed. One Touch Recording is not possible in TAPE mode.

CD Synchro Start Recording

- 1 Load a blank tape into tape deck 2 and a disc into a disc tray.
- 2 Press **CD** to select CD mode.
 - You can program the tracks in the order you want them to be recorded (see Programming Tracks). If not, select the disc by pressing **CD** (CD 1•2•3) and the tracks are recorded according to the order on the selected disc.
- 3 Press **RECORD** to start recording.
→ The REC flag starts flashing.
 - CD will start playback automatically.
- 4 Press **■** to stop recording.

RECORDING

English

Dubbing tapes (from tape deck 1 to tape deck 2)

- 1 Press **TAPE** (TAPE 1•2) to select tape deck 2.
- 2 Load the prerecorded tape into tape deck 1 and a blank tape into tape deck 2 with full spool to the left.
- 3 Press **DUBBING**
→ "DUB" with ">" scrolling right will be displayed.
 - Dubbing will start immediately.
→ The **REC** flag starts flashing.
- 4 Press **■** to stop dubbing.

Notes:

- At the end of side A, flip the tapes to side B and repeat the procedure.
- Dubbing of tapes is only possible from tape deck 1 to tape deck 2.
- To ensure good dubbing, use tapes of the same length.
- You can listen to other source while dubbing.

Recording from other sources (only on tape deck 2)

- 1 Press **TAPE** (TAPE 1•2) to select tape deck 2.
- 2 Load a blank tape into tape deck 2 with the open side downward.
- 3 Press **CD, TUNER** or **AUX**.
 - Start playback of the selected source.
- 4 Press **RECORD** to start recording.
→ The **REC** flag starts flashing.
- 5 Press **■** to stop recording.

Notes:

- During recording, it is not possible to listen to another source.

Digital Recording via Digital Out

For CD digital recording, please refer to the Instructions Manual of the CD Recorder, digital audio equipment, etc.

CLOCK

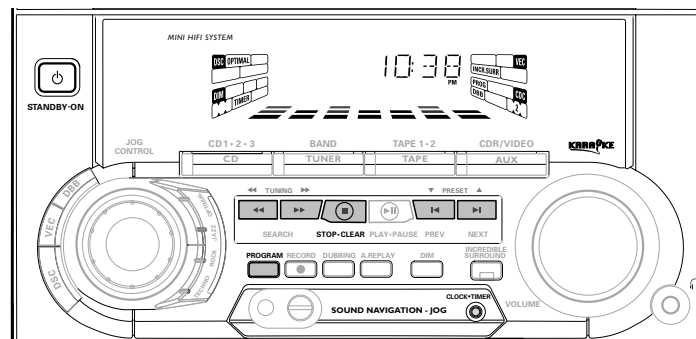

View Clock

You can view the clock (if it is set) if the system is in Standby mode or when any sound source is selected (CD, TUNER, etc.). The clock will be displayed for about seven seconds.

- Press **CLOCK•TIMER** briefly.
 - " 10:38 PM or 22:38 " (the current time in either 12- or 24-hour mode) will be displayed depending on whether you have selected 12- or 24-hour mode.
 - " --- : --- " will be displayed if the clock is not set.

Clock Setting

The clock can be set in either 12- or 24-hour mode, e.g. " 12:00 AM " or " 00:00 ". Before setting the clock, you must be in the View Clock mode.

- 1 Press **CLOCK•TIMER** to select clock mode.
- 2 Press **PROGRAM** to select 12- and 24-hour mode.
 - If 12-hour mode is selected, " 12:00 " starts flashing and the **AM** lights up.
 - If 24-hour mode is selected, " 00:00 " starts flashing.
- 3 Set the hour with **◀◀** or **▶▶** on the system.
- 4 Set the minute with **◀** or **▶** on the system.

TIMER

- Press **CLOCK•TIMER** again to store the setting.
→ The clock starts.
- To exit without storing the setting, press **■** on the system.

Notes:

- During clock setting, if no button is pressed within 90 seconds, the system will exit clock setting mode automatically.
- When a power interruption occurs, the clock setting is erased.

Timer Setting

- The system can switch on to CD, TUNER or TAPE 2 mode automatically at a preset time. It can serve as an alarm to wake you up.
 - Before setting the timer, make sure the clock is set correctly.
 - The timer will always be switched on once it is set.
 - **The volume of the timer will increase from the minimum level until the volume level before the set is switched to standby mode.**
- Press and hold **CLOCK•TIMER** for more than **2 seconds** to select timer mode.
→ "12:00 AM" or "00:00" or the last timer setting starts flashing depending on whether you have selected 12- or 24-hour mode.
→ The **TIMER** flag starts flashing.

- The selected source is lit while other available sources are flashing.
- Press **CD, TUNER** or **TAPE** to select the desired source.
 - Before selecting CD or TAPE, make sure a CD or tape is loaded in the CD carousel tray or tape deck 2
 - Press **◀** or **▶** on the system to set the hour for the timer to start.
 - Press **⏪** or **⏩** on the system to set the minute for the timer to start.
 - Press **CLOCK•TIMER** to store the start time.
→ The timer is now set.
→ The **TIMER** flag remains on the display.
 - At the preset time, the timer will be activated.
→ The selected source will be played.

Notes:

- During timer setting, if no button is pressed within 90 seconds, the system will exit timer setting mode automatically.
- If the source selected is **TUNER**, the last tuned frequency will be switched on.
- If the source selected is **CD**, playback will begin with the first track of the selected disc or program. If the CD trays are empty, the **TUNER** will be selected instead.
- The timer will not activate if a recording is in progress.

SLEEP TIMER

Sleep Timer (only on remote control)

This feature allows you to select a length of time after which the system will switch to the standby mode automatically.

- Press **SLEEP** on the remote control repeatedly to select a period of time.
→ The selections are as follows (time in minutes):
60 → 45 → 30 → 15 → OFF → 60
...
→ "SLEEP XX" or "OFF" will be displayed. "XX" is the time in minutes.
- When you reach the desired length of time, stop pressing the **SLEEP** button.
→ After this amount of time passes, the system will switch to the standby mode.

To switch off the Sleep Timer

- Press **SLEEP** repeatedly until "OFF" is displayed, or press the **STANDBY ON** button.

To switch off the TIMER

- Press and hold **CLOCK•TIMER** for more than **2 seconds**.
- Press **■** on the system to cancel the timer.
→ The timer is now switched off.
→ The display will show "CANCEL" and the **TIMER** flag disappears.

To start the TIMER again (for the same preset time and source)

- Press and hold **CLOCK•TIMER** for more than **2 seconds**.
- Press **CLOCK•TIMER** again to store the start time.
→ The timer is now on.
→ The **TIMER** flag appears on the display.

Specifications

AMPLIFIER

Output power	
FW-C38	1000 W PMPO / 2 X 30 W RMS ⁽¹⁾
FW-C39	1000 W PMPO / 2 X 30 W RMS ⁽¹⁾
Surround Channel	2 x 5 W RMS, 6 Ω
Signal-to-noise ratio	≥ 67 dBA (IEC)
Frequency response	50 – 15000 Hz, ± 3dB
Input sensitivity	
AUX In	700 mV
Microphone (not available for version /30)	3.5 mV
Output	
Speakers	≥ 6 Ω
Surround Speakers (for FW-C39 only)	≥ 6 Ω
Headphones	32 Ω – 1000 Ω
Subwoofer Out	1.5 V
Digital (Coax) out	IEC 958, 44.1kHz

⁽¹⁾ (6Ω,1kHz, 10% THD)

CD PLAYER

Number of programmable tracks	40
Frequency response	20 – 20000 Hz
Signal-to-noise ratio	≥ 80 dBA
Channel separation	≥ 60 dB (1 kHz)
Total harmonic distortion	< 0.003%

TUNER

FM wave range	87.5 – 108 MHz
MW wave range (9 kHz)	531 – 1602 kHz
MW wave range (10 kHz)	530 – 1700 kHz
Tuning grid	9/10 kHz
Number of presets	40
Antenna	
FM	75 Ω wire
AM	Loop antenna

22

TAPE DECK

Frequency range	
Chrome tape (type II)	80 – 12500 Hz (8 dB)
Normal tape (type I)	80 – 12500 Hz (8 dB)
Signal-to-noise ratio	
Chrome tape (type II)	≥ 52 dBA
Normal tape (type I)	≥ 48 dBA
Wow and flutter	≤ 0.4% DIN

SPEAKERS

System	2 way; double port bass reflex
Impedance	6 Ω
Woofer	1 x 5.25"
Tweeter	1 x 2.5"
Dimensions (w x h x d)	210x 310x 240 (mm)
Weight	2.8 kg each

SS-39 SURROUND SPEAKERS

(FWC39 only)	
System	closed satellite
Impedance	6 Ω
Woofer	1 x 3" full range
Dimensions (w x h x d)	178x 90x 178 (mm)
Weight	0.6 kg each

GENERAL INFORMATION

Material	Polystyrene
AC Power	
For Version /21 & /21M	110 - 127 / 220 - 240 V;
	50/60Hz; Switchable
For Version /30	230 - 240 V; 50 Hz
Power Consumption	
Active	75 W
Standby	< 25 W
Dimensions (w x h x d)	265x 310x 340 (mm)
Weight (without speakers)	6.6 kg

Subject to modification

MAINTENANCE

Maintenance

Cleaning the Cabinet

- Use a soft cloth slightly moistened with a mild detergent solution. Do not use a solution containing alcohol, spirits, ammonia or abrasives.

Cleaning Discs

- When a disc becomes dirty, clean it with a cleaning cloth. Wipe the disc from the center out.
- Do not use solvents such as benzine, thinner, commercially available cleaners, or antistatic spray intended for analog records.



Cleaning the CD lens

- After prolonged use, dirt or dust may accumulate at the CD lens. To ensure good playback quality, clean the CD lens with Philips CD Lens Cleaner or any commercially available cleaner. Follow the instructions supplied with cleaner.

Cleaning the Heads and the Tape Paths

- To ensure good recording and playback quality, clean the heads, the capstan(s), and pressure roller(s) after every 50 hours of tape operation.
- Use a cotton swab slightly moistened with cleaning fluid or alcohol.
- You can also clean the heads by playing a cleaning tape once.

Demagnetizing the heads

- Use a demagnetizing tape available at your dealer.

Warning! Under no circumstances should you try to repair the set yourself as this will invalidate the guarantee. Do not open the set as there is a risk of electric shock.

- If a fault occurs, check the points listed below before taking the system for repair.
- Should any problems persist after you have made these checks, consult your nearest dealer or service center.

CD Player Operation

"NO DISC" is displayed.

- The disc is inserted upside down.
→ *Place CD with printed side up.*
- Moisture condensation at the lens.
→ *Wait until lens has adjusted to normal room temperature.*
- There is no disc in the CD tray.
→ *Insert a CD.*
- The CD is dirty, badly scratched or warped.
→ *Clean or replace the CD.*
- The CD lens is dirty or dusty.
→ *See section under Maintenance (page 23).*

TROUBLESHOOTING

"DISC NOT FINALIZED" is displayed.

- The CD-RW or CD-R disc is not properly recorded for use with a standard CD player.
→ *Read the instruction booklet of your CD-Rewritable or CD-Recorder on how to finalize a recording.*
- The CD is badly scratched or dirty.
→ *Replace or clean CD.*

Radio Reception

Poor radio reception.

- The signal is too weak.
→ *Adjust the antenna.*
→ *Connect an external antenna for better reception.*
- The TV or VCR is too close to the stereo system.
→ *Separate the stereo system from the TV or VCR.*

Cannot tune to station

- Wrong tuning grid.
→ *Switch to the correct tuning grid.*

English

TROUBLESHOOTING

English

Tape Deck Operation

"RECORDING ACTIVE" is displayed.

- A recording is in progress.
- *Stop the recording or wait until it is finished.*

"TAPE DUBBING ONLY" is displayed.

- Tape dubbing is only possible in tape mode.
- *Switch source to tape mode.*

Recording or playback cannot be made or there is a decrease in audio level.

- Dirty tape heads, capstans or pressure rollers.
- *See section on tape deck maintenance (page 23).*
- Magnetic build-up in the record/playback head.
- *Use demagnetizing tape.*

Tape deck door cannot open.

- Power failure or AC power plug disconnect from the wall outlet during tape playback.
- *Reconnect the AC power plug and switch on the system again.*

General

System does not react when any button is pressed.

- Electrostatic discharge.
- *Press STANDBY ON to switch the system off. Remove the AC power plug from the wall outlet, then reconnect the power plug and switch on the system again.*

No or poor sound.

- Volume is not turned up.
- *Adjust VOLUME.*
- The headphones are connected.
- *Disconnect the headphones.*
- Speakers are not connected or are connected wrongly.
- *Check that the speakers are connected correctly.*
- *Make sure the stripped speaker wire is clamped.*

Reversed left and right sound.

- Speakers are connected wrongly.
- *Check the speaker connections and location.*

Lack of bass sound or apparently imprecise physical location of musical instruments.

- Speakers are connected wrongly.
- *Check the speaker connection for proper phasing, colored/black wires to colored/black terminals.*

Remote control has no effect on the system.

- Wrong source is selected.
- *Select the source (CD, TUNER, etc.) before pressing the function button, (▶, ◀, ▶, etc.).*
- The distance to the system is too large.
- *Reduce the distance.*
- Batteries are inserted incorrectly.
- *Insert the batteries with their polarities (+/- signs) as indicated.*
- Batteries are exhausted.
- *Replace the batteries.*

Timer is not working.

- Clock is not set.
- *Set the clock.*
- Timer is not switched on.
- *Press CLOCK•TIMER to switch on the timer.*
- Recording is in progress.
- *Stop recording.*

Clock setting is erased.

- There was a power failure.
- *Reset the clock.*

System displays features automatically; buttons flash continuously.

- Demonstration mode is switched on.
- *Press and hold ■ (on the system) for 5 seconds to switch off the demonstration.*

All lighted buttons are not lit.

- Display is switch on in DIM 3 mode.
- *Press DIM until DIM OFF display mode is shown.*