



Mini Hi-Fi System



Let's make things better.



PHILIPS





Important notes for users in the U.K.

Mains plug

This apparatus is fitted with an approved 13 Amp plug. To change a fuse in this type of plug proceed as follows:

- 1 Remove fuse cover and fuse.
- 2 Fix new fuse which should be a BS1362 5 Amp, A.S.T.A. or BSI approved type.
- 3 Refit the fuse cover.

If the fitted plug is not suitable for your socket outlets, it should be cut off and an appropriate plug fitted in its place.

If the mains plug contains a fuse, this should have a value of 5 Amp. If a plug without a fuse is used, the fuse at the distribution board should not be greater than 5 Amp.

Note: The severed plug must be disposed of to avoid a possible shock hazard should it be inserted into a 13 Amp socket elsewhere.

How to connect a plug

The wires in the mains lead are coloured with the following code: blue = neutral (N), brown = live (L).

- As these colours may not correspond with the colour markings identifying the terminals in your plug, proceed as follows:
 - Connect the blue wire to the terminal marked N or coloured black.
 - Connect the brown wire to the terminal marked L or coloured red.
 - Do not connect either wire to the earth terminal in the plug, marked E (or \perp) or coloured green (or green and yellow).

Before replacing the plug cover, make certain that the cord grip is clamped over the sheath of the lead - not simply over the two wires.

Copyright in the U.K.

Recording and playback of material may require consent. See Copyright Act 1956 and The Performer's Protection Acts 1958 to 1972.

Italia

DICHIARAZIONE DI CONFORMITA'

Si dichiara che l'apparecchio FW-C399 Philips risponde alle prescrizioni dell'art. 2 comma 1 del D.M. 28 Agosto 1995 n. 548.

Fatto a Eindhoven

Philips Consumer Electronics
Philips, Glaslaan 2
5616 JB Eindhoven, The Netherlands

Norge

Typeskilt finnes på apparatens underside.

Observer: Nettbryteren er sekundert innkoplet. Den innebygde nettdelen er derfor ikke frakoplet nettet så lenge apparatet er tilsluttet nettkontakten.

For å redusere faren for brann eller elektrisk støt, skal apparatet ikke utsettes for regn eller fuktighet.

CAUTION

Use of controls or adjustments or performance of procedures other than herein may result in hazardous radiation exposure or other unsafe operation.

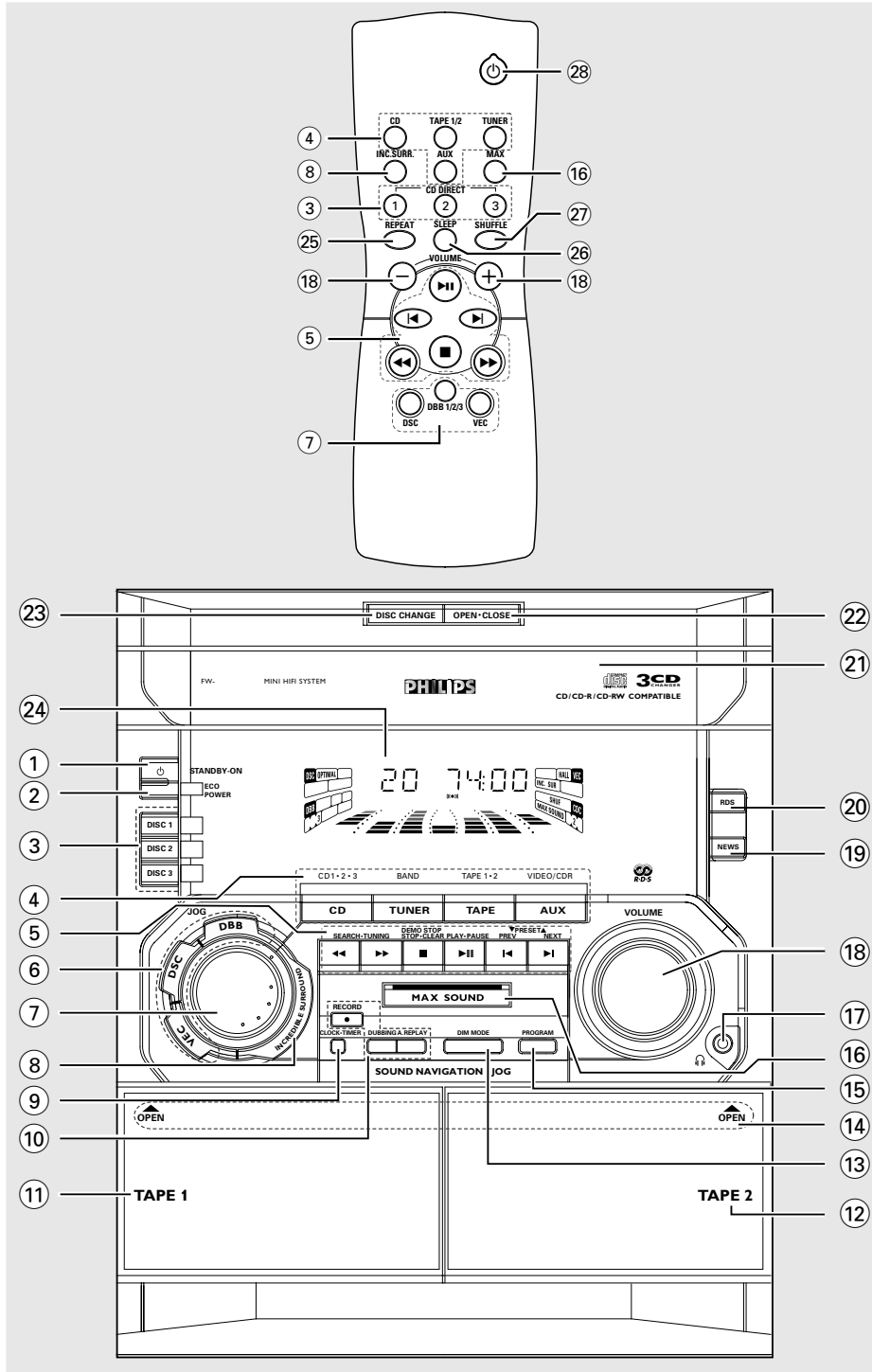

3



DK

Advarsel: Usynlig laserstråling ved åbning når sikkerhedsafbrydere er ude af funktion. Undgå udsættelse for stråling.

Bemærk: Netafbryderen er sekundært indkoblet og afbryder ikke strømmen fra nettet. Den indbyggede netdel er derfor tilsluttet til lysnettet så længe netstikket sidder i stikkontakten.

S

Klass 1 laseraparät

Varning! Om apparaten används på annat sätt än i denna bruksanvisning specificerats, kan användaren utsättas för osynlig laserstråling, som överskrider gränsen för laserklass 1.

Observera! Stömbrytaren är sekundärt kopplad och bryter inte strömmen från nätet. Den inbyggda nätdelen är därför ansluten till elnätet så länge stickproppen sitter i vägguttaget.

SF

Luokan 1 laserlaite

Varoitus! Laitteen käyttäminen muulla kuin tässä käyttöohjeessa mainitulla tavalla saattaa altistaa käyttäjän turvallisuusluokan 1 ylittävälle näkymättömälle lasersäteilylle.

Oikeus muutoksiin varataan. Laite ei saa olla alttiina tippu- ja roiskevedelle.

Huom. Toiminnanvalitsin on kytketty toisiopuolelle, eikä se kytke laitetta irti sähköverkosta. Sisäänrakennettu verkko-osa on kytketty sähköverkkoon aina silloin, kun pistoke on pistorasiassa.

DEMO MODE

To turn ON

Press & HOLD



button

for 5 seconds

To turn OFF

Press & HOLD



button

for 5 seconds

PLUG & PLAY

1



Plug in the unit

2



Follow instructions
in the display

3



Press "PLAY"



Index

English 6

Français 31

Español 56

Deutsch 81

Nederlands 107

Italiano 132

Svenska 157

Dansk 182

Suomi 207

Português 232

Ελληνικά 257

- English
- Français
- Español
- Deutsch
- Nederlands
- Italiano
- Svenska
- Dansk
- Suomi
- Português
- Ελληνικά





Contents

General Information

- Supplied accessories 7
- Acknowledgement 7
- Environmental information 7
- Safety information 7

Preparations

- Rear connections 8–9
 - Power
 - Antennas connection
 - Speakers connection
- Optional connection 9
 - Connecting other equipment to your system
- Inserting batteries into the remote control 9

Controls

- Controls on the system and remote control 10–11

Basic Functions

- Plug and Play 12
- Demonstration mode 13
- Switching the system on 13
- Switching the system to standby mode 13
- Switching the system to Eco Power standby mode 13
- Dim mode 13
- Volume control 14
- Sound navigation 14–15
 - MAX sound
 - VEC (Virtual Environment Control)
 - DSC (Digital Sound Control)
 - DBB (Dynamic Bass Boost)
 - Incredible Surround

CD Operation

- Discs for playback 16
- Loading discs 16
- Playing discs 17
- Selecting a desired track/passage 17
- Replacing discs during playback 17
- Repeat and Shuffle 17
 - Repeat play
 - Random play
- Programming the disc tracks 18
- Erasing the programme 18

Radio Reception

- Tuning to radio stations 19
- Storing preset radio stations 19–20
 - Automatic preset programming
 - Manual preset programming
- Tuning to preset radio stations 20
- RDS 20–21
 - Setting the RDS clock
- NEWS 21

Tape Operation/Recording

- Loading tape 22
- Playing tapes 23
- Rewinding/Fast forwarding 23
- General information on recording 23
- Preparation for recording 24
- One touch recording 24
- CD Synchronised start recording 24
- Dubbing tapes 24

Clock/Timer

- View clock 25
- Clock setting 25
- Timer setting 26
 - Deactivating the timer
 - Activating the timer
- Sleep timer setting 26–27

External Sources

- Listening to external sources 27

Specifications 28

Maintenance 29

Troubleshooting 29–30



General Information

This product complies with the radio interference requirements of the European Community.

Supplied accessories

- 2 speaker boxes
- remote control
- batteries (two AA size) for remote control
- AM loop antenna
- FM wire antenna
- AC power cord

Acknowledgement

Energy Star

As an ENERGY STAR® Partner, Philips has determined that this product meets the ENERGY STAR® guidelines for energy efficiency.



Environmental information

All unnecessary packaging has been omitted. We have tried to make the packaging easy to separate into three materials: cardboard (box), polystyrene foam (buffer) and polyethylene (bags, protective foam sheet).

Your system consists of materials which can be recycled and reused if disassembled by a specialised company. Please observe the local regulations regarding the disposal of packaging materials, exhausted batteries and old equipment.

Safety information

- Before operating the system, check that the operating voltage indicated on the typeplate (or the voltage indication beside the voltage selector) of your system is identical with the voltage of your local power supply. If not, please consult your dealer.
- Place the system on a flat, hard and stable surface.
- Place the system in a location with adequate ventilation to prevent internal heat build-up in your system. Allow at least 10 cm (4 inches) clearance from the rear and the top of the unit and 5 cm (2 inches) from each side.
- Do not expose the system, batteries or discs to excessive moisture, rain, sand or heat sources caused by heating equipment or direct sunlight.
- The lens may cloud over when the system is suddenly moved from cold to warm surroundings, making it impossible to play a disc. Leave the system in the warm environment until the moisture evaporates.
- The mechanical parts of the set contain self-lubricating bearings and must not be oiled or lubricated.
- **When the system is switched to Standby mode, it is still consuming some power. To disconnect the system from the power supply completely, remove the AC power plug from the wall socket.**



Preparations

English

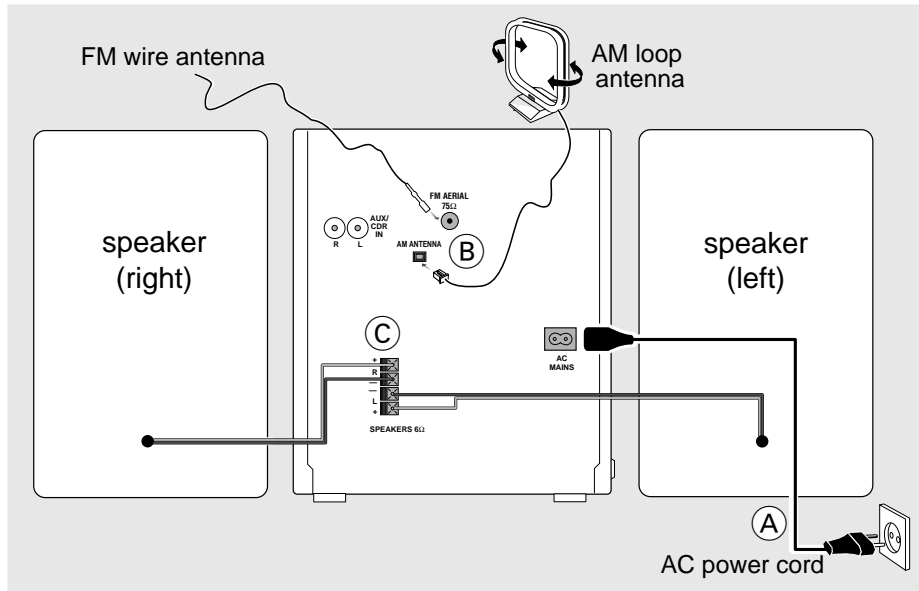

Rear connections

The type plate is located at the rear of the system.

For users in the U.K.: please follow the instructions on page 2.

A Power

Before connecting the AC power cord to the wall outlet, ensure that all other connections have been made.

WARNING!

- For optimal performance, use only the original power cable.
- Never make or change any connections with the power switched on.

To avoid overheating of the system, a safety circuit has been built in. Therefore, your system may switch to Standby mode automatically under extreme conditions. If this happens, let the system cool down before reusing it (not available for all versions).

B Antennas Connection

Connect the supplied AM loop antenna and FM antenna to the respective terminals. Adjust the position of the antenna for optimal reception.

AM Antenna

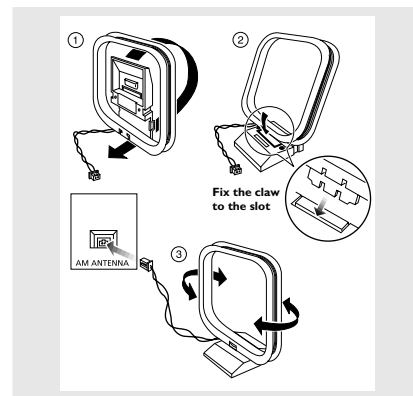

- Position the antenna as far as possible from a TV, VCR or other radiation source.



Preparations

FM Antenna

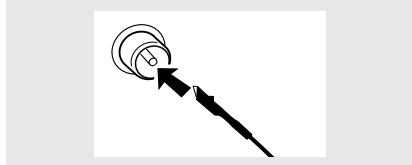

- For better FM stereo reception, connect an outdoor FM antenna to the FM ANTENNA terminal.

Speakers Connection

Front Speakers

Connect the speaker wires to the SPEAKERS terminals, right speaker to "R" and left speaker to "L", coloured (marked) wire to "+" and black (unmarked) wire to "-".

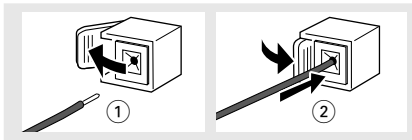

- Fully insert the stripped portion of the speaker wire into the terminal as shown.

Notes:

- For optimal sound performance, use the supplied speakers.
- Do not connect more than one speaker to any one pair of +/– speaker terminals.
- Do not connect speakers with an impedance lower than the speakers supplied. Please refer to the SPECIFICATIONS section of this manual.

Optional connection

The optional equipment and connecting cords are not supplied. Refer to the operating instructions of the connected equipment for details.

Connecting other equipment to your system

Use a cinch cable to connect **AUX/CDR IN** to the analogue audio out terminals of an external equipment (TV,VCR, Laser Disc player, DVD player or CD Recorder).

Note:

- If you are connecting equipment with a mono output (a single audio out terminal), connect it to the AUX/CDR IN left terminal. Alternatively, you can use a "single to double" cinch cable (the output sound still remain mono).

Inserting batteries into the remote control

Insert two batteries (Type R06 or AA) into the remote control with the correct polarity as indicated by the "+" and "-" symbols inside the battery compartment.

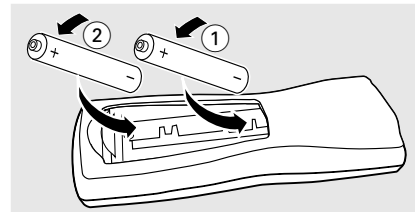

CAUTION!

- Remove batteries if they are exhausted or will not be used for a long time.
- Do not use old and new or different types of batteries in combination.
- Batteries contain chemical substances, so they should be disposed off properly.



Controls (illustrations on page 3)

Controls on the system and remote control

- ① **STANDBY ON**
 - to switch the system on or to standby mode.
- ② **ECO POWER**
 - to switch the system on or to Eco Power standby mode.
- ③ **DISC 1/2/3 (CD DIRECT 1/2/3)**
 - to select a disc tray for playback.
- ④ **Source selection** – to select the following :
 - CD** (CD 1•2•3)
 - to select disc tray 1, 2 or 3.
 - TUNER** (BAND)
 - to select waveband : FM, MW or LW.
 - TAPE** (TAPE 1•2)
 - to select tape deck 1 or 2.
 - AUX** (VIDEO/CDR)
 - to select the input for an additional appliance : AUX or CDR.
- ⑤ **Mode Selection**
 - ◀▶ SEARCH•TUNING**
 - for CD to search backward/forward.
 - for Tuner to tune to a lower or higher radio frequency.
 - for Tape to rewind or fast forward.
 - for Clock (on the system only) to set the hour.
 - STOP•CLEAR (DEMO STOP)**
 - for CD to stop playback or to clear a programme.
 - for Tuner (on the system only) to stop programming.
 - for Tape to stop playback or recording.
 - for Demo (on the system only) to activate/deactivate the demonstration.
 - for Clock (on the system only) to exit clock setting or cancel timer.
 - for Plug & Play... (on the system only) to exit plug & play mode.

▶ II PLAY•PAUSE

- for CD to start or interrupt playback.
- for Tape to start playback.
- for Plug & Play... (on the system only) to initiate and start plug & play mode.

◀ PREV / ▶ NEXT (▼ PRESET ▲)

- for CD to skip to the beginning of the current, previous, or next track.
- for Tuner to select a preset radio station.
- for Clock (on the system only) to set the minute.

⑥ SOUND NAVIGATION

- to select and activate the JOG control for the desired sound feature : DBB, DSC or VEC.

⑦ JOG

- to select the desired sound effect for the selected sound feature.
- DBB** DBB 1, DBB 2 or DBB 3.
- DSC** OPTIMAL, JAZZ, ROCK or TECHNO.
- VEC** CINEMA, HALL or CONCERT.

⑧ INCREDIBLE SURROUND (INC. SURR.)

- to activate or deactivate the surround sound effect.

⑨ CLOCK•TIMER

- to view the clock, set the clock or set the timer.

⑩ Tape Deck Operation

- RECORD** ●
 - to start recording on tape deck 2.
- DUBBING**
 - to dub a tape.
- A. REPLAY**
 - to select continuous playback in either AUTO REPLAY or ONCE mode only.

⑪ Tape deck 1

⑫ Tape deck 2



Controls

English

⑬ DIM MODE

- to select different brightness for the display screen : DIM 1, DIM 2, DIM 3 or DIM OFF.

⑭ ▲ OPEN

- to open the tape deck door.

⑮ PROGRAM

- for CD to programme disc tracks.
- for Tuner to programme preset radio stations.
- for Clock to select 12- or 24-hour clock mode.

⑯ MAX SOUND (MAX)

- to activate or deactivate the optimal mix of various sound features.

⑰

- to connect headphones.

⑱ VOLUME (VOLUME + / -)

- to increase or decrease the volume.

⑲ NEWS

- to hear News automatically.

⑳ RDS

- to select RDS information.

㉑ Disc tray

㉒ OPEN•CLOSE

- to open or close the disc tray.

㉓ DISC CHANGE

- to change disc(s).

㉔ Display screen

- to view the current status of the system.

㉕ REPEAT

- to playback track(s)/disc(s)/programme repeatedly.

㉖ SLEEP

- to activate/deactivate or set the sleep timer.

㉗ SHUFFLE

- to playback all available discs and their tracks/ programme in random order.

㉘

- to switch the system to standby mode.
- to switch the system to Eco Power standby mode.

Notes for remote control:

- **First, select the source you wish to control by pressing one of the source select keys on the remote control (CD or TUNER, for example).**
- **Then select the desired function (▶, ◀, ▶|, for example).**



Basic Functions

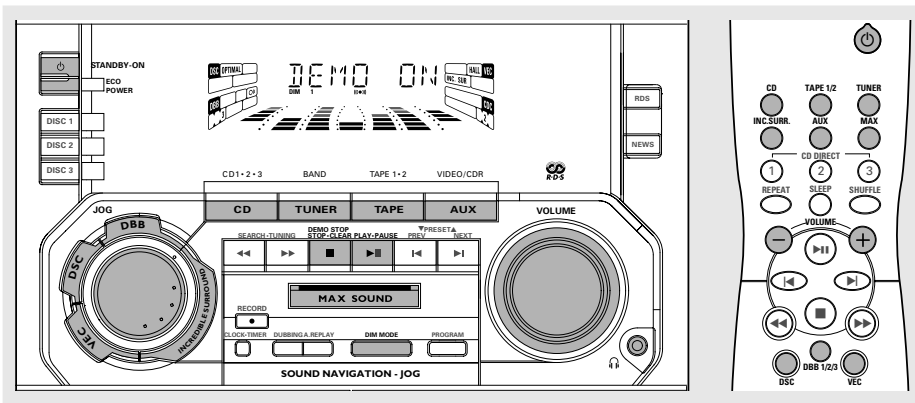

IMPORTANT!

Before you operate the system, complete the preparation procedures.

Plug and Play

Plug and Play allows you to store all available RDS stations and radio stations automatically.

First time setup/power up

- When you turn on the main supply, "AUTO INSTALL - PRESS PLAY" is displayed.
- Press **▶||** on the system to start installation.
 - "INSTALL" is displayed, followed by "TUNER" and "AUTO".
 - **PROG** starts flashing.
 - The system will automatically store the radio stations with sufficient signal strength, starting from all RDS stations and followed by FM, MW and LW bands respectively. Weak RDS stations may be stored in later presets.
 - When all the available radio stations are stored or the memory for 40 presets are used, the last preset radio station (or the first available RDS station) will be played.
- The system will proceed to set the RDS clock if the first preset is an RDS station.
 - "INSTALL" is displayed, followed by "TIME" and "SEARCH RDS TIME".
 - When RDS time is read, "RDS TIME" is displayed and the current time will be stored.

→ If RDS station does not transmit RDS time within 90 seconds, the programme will exit automatically and the display will show "NO RDS TIME".

- If the first preset is non-RDS station;
 - The programme will exit automatically.

To reinstall Plug and Play

- In standby or demonstration mode, press and hold **▶||** on the system until "AUTO INSTALL - PRESS PLAY" is displayed.
- Press **▶||** again to start installation.
 - All previously stored radio stations will be replaced.

To exit without storing the Plug and Play

- Press **■** on the system.
 - If you do not complete the Plug and Play installation, the function will be restarted when you next turn on the main supply again.

Notes:

- When the power is turned on, the disc tray may open and close to initialise the system.
- If no stereo frequency is detected during Plug and Play, "CHECK ANTENNA" will be displayed.
- During Plug and Play, if no button is pressed within 15 seconds, the system will exit Plug and Play mode.



Basic Functions

Demonstration mode

The system has a demonstration mode that shows the various features offered by the system.

To activate the demonstration

- In standby mode, press and hold **■** on the system until "DEMO ON" is displayed.
→ The demonstration will begin.

To deactivate the demonstration

- Press and hold **■** on the system until "DEMO OFF" is displayed.
→ The system will switch to standby mode.

Switching the system on

In standby/demonstration mode

- Press **STANDBY ON** to switch on the last selected source.
- Press **CD, TUNER, TAPE (TAPE 1/2) or AUX**.
- Press **OPEN•CLOSE**.
→ The system will switch to CD mode.

In Eco Power standby mode

- Press **ECO POWER** to switch on the last selected source.
- Press **CD, TUNER, TAPE 1/2 or AUX** on the remote control.

Switching the system to standby mode

In demonstration mode

- Press and hold **■** on the system.

In any other source mode (except Eco Power standby mode)

- Press **STANDBY ON** (or **⏻** on the remote control).
→ The clock will appear on the display when the system is in standby mode.

Switching the system to Eco Power standby mode (< 1 Watt)

- Press **ECO POWER** (or press and hold **⏻** on the remote control).
→ "ECO PWR" is displayed, then the display screen will go blank.
→ The low power ECO POWER LED will be lighted.

Note:

– If you have not deactivated the demonstration, it will resume five seconds after the system switches to Eco Power standby or standby mode.

Dim mode

You can select the desired brightness for the display.

- In any source mode (except Eco Power standby or standby mode), press **DIM MODE** repeatedly to select DIM 1, DIM 2, DIM 3 or DIM OFF display mode.
→ **DIM** is shown, except for DIM OFF mode.

DIM mode	Brightness	Spectrum Analyser
1	normal	off
2	half	on
3	half	off
OFF	normal	on



Basic Functions

Volume control

Adjust **VOLUME** to increase (turn knob clockwise or press VOLUME +) or decrease (turn knob anti-clockwise or press VOLUME -) the sound level.

To listen through the headphones

- Connect the headphones plug to the  socket at the front of the system.
→ The speakers will be muted.

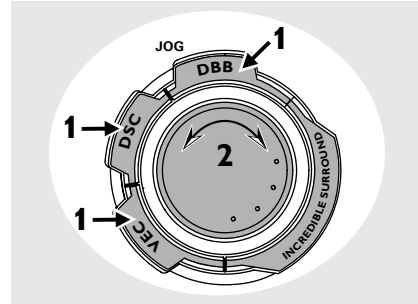
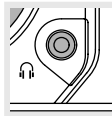

Sound navigation

For optimal sound listening, select only one of the following navigation sound controls at a time : MAX SOUND, DSC or VEC.

MAX Sound

MAX sound provides the best mixture of various sound features (DSC, VEC, DBB, for example).

- Press **MAX SOUND** (or **MAX** on the remote control) repeatedly.



- If activated, **MAX SOUND** is shown and the MAX SOUND button lights up.
- If deactivated, "MAX OFF" is displayed.

Note:

– When MAX sound is selected, all other sound navigation will switch off automatically.

VEC (Virtual Environment Control)

The VEC feature enables you to adjust the system to select a type of environment.

- 1 Press **VEC**.
→ The selected VEC is shown.
- 2 Adjust the **JOG** control (or press **VEC** on the remote control repeatedly) to select : CINEMA, HALL or CONCERT.

Note:

– When you select VEC, Incredible Surround will switch on automatically.

DSC (Digital Sound Control)

The DSC feature enables you to enjoy special sound effects that have preset equaliser settings, providing the best music reproduction.

- 1 Press **DSC**.
→ The selected DSC is shown.
- 2 Adjust the **JOG** control (or press **DSC** on the remote control repeatedly) to select : OPTIMAL, JAZZ, ROCK or TECHNO.



Basic Functions

DBB (Dynamic Bass Boost)

There are three DBB settings to enhance the bass response.

- 1 Press **DBB**.
→ The selected **DBB** is shown, except for DBB OFF mode.
- 2 Adjust the **JOG** control (or press **DBB 1/2/3** on the remote control repeatedly) to select :
DBB 1, DBB 2, DBB 3 or DBB OFF.

Note:

– Some discs or tapes might be recorded in high modulation, which causes a distortion at high volume. If this occurs, switch off DBB or reduce the volume.

Automatic DSC-DBB selection

The best DBB setting is generated automatically for each DSC selection. You can manually select the DBB setting that best suits your listening environment.

DSC	DBB
JAZZ	off
ROCK	on (3)
TECHNO	on (3)
OPTIMAL	on (2)

Incredible Surround

The Incredible Surround magnifies the virtual distance between the front speakers for an incredibly wide, enveloping, stereo effect.

- Press **INCREDIBLE SURROUND** (or **INC. SURR.** on the remote control) repeatedly.
→ If activated, **INC. SUR** is shown and "INCER SURROUND" is displayed.
→ If deactivated, "IS OFF" is displayed.



CD Operation

English

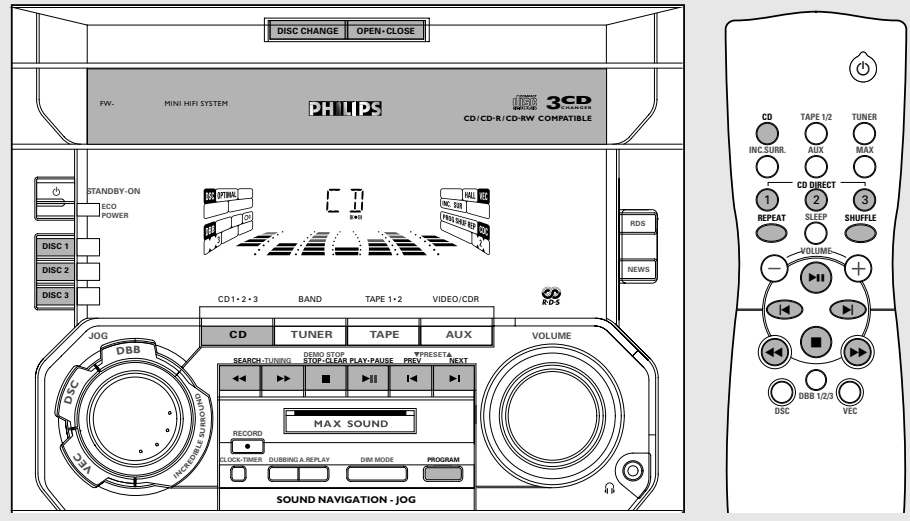

IMPORTANT!

- This system is designed for regular discs. Therefore, do not use any accessories such as disc stabiliser rings or disc treatment sheets, etc., as offered on the market, because they may jam the changer mechanism.
- Do not load more than one disc into each tray.

Discs for playback

This system can playback all digital audio CD, finalised digital audio CD-Recordable (CDR) discs and finalised digital audio CD-Rewritable (CDRW) discs.



Loading discs

- 1 Press **OPEN•CLOSE** to open the disc tray.
- 2 Load up to two discs on the individual disc trays. To load the third disc, press **DISC CHANGE**.
→ The disc tray will rotate until the empty tray is ready for loading.

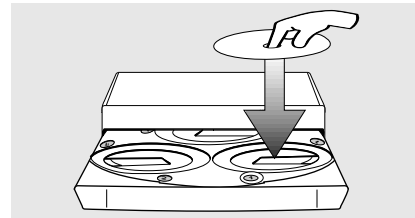

- 3 Press **OPEN•CLOSE** to close the disc tray.
→ "READING" is displayed. The selected disc tray, total number of tracks and the playing time will appear on the display.
→ A lighted button indicates that a disc is loaded on the disc tray.

Notes:

- Load the discs with the label side facing up.
- To ensure good system performance, wait until the disc tray completely reads the disc(s) before proceeding.



CD Operation

Playing discs

To play all discs on the disc tray

- Press **▶II**.
 - All the available discs will play once, then stop.
 - During playback, the selected disc tray, track number and elapsed playing time of the current track are displayed.

To play the selected disc only

- In CD mode, press **DISC 1/2/3** (or **CD DIRECT 1/2/3** on the remote control).
 - The selected disc will play once, then stop.

To interrupt playback

- Press **▶II**.
 - The current track time flashes.
- To resume playback, press **▶II** again.

To stop playback

- Press **■**.

Selecting a desired track/passage

To search for a particular passage during playback

- Press and hold **◀◀** or **▶▶** and release it when the desired passage is located.
 - During searching, the volume will be reduced.

To select a desired track

- Press **◀** or **▶** repeatedly until the desired track is displayed.
- If playback is stopped, press **▶II** to start playback.

Note:

– In Shuffle mode, pressing **◀** will cause the player to skip only to the beginning of the current track.

To skip to the beginning of the current track during playback

- Press **◀** once.

Replacing discs during playback

- 1 Press **DISC CHANGE**.
 - The disc tray will open without interrupting current playback.
- 2 To change the inner disc, press **DISC CHANGE** again.
 - "DISC CHANGE" is displayed and the disc will stop playing.
 - The disc tray will close to retrieve the inner disc, then reopen with the inner disc accessible.

Repeat and Shuffle

You can select and change the various play modes before or during playback.

Repeat play

- 1 Press **REPEAT** on the remote control repeatedly to select:
 - "TRACK" – to repeat playback of the current track.
 - "DISC" – to repeat playback of the current disc.
 - "ALL DISC" or "PROGRAM" – to repeat playback of all available discs or programmed tracks.
- 2 To resume normal playback, press **REPEAT** until "OFF" is displayed.
 - **REP** is shown, except for REPEAT OFF mode.

Random play

- 1 Press **SHUFFLE** on the remote control.
 - **SHUF** is shown and "SHUFFLE" is displayed.
 - All the available discs or programmed tracks (if programme is active) will be played in random order.
- 2 To resume normal playback, press **SHUFFLE** again.
 - **SHUF** disappears.

Notes:

– During programme play or shuffling mode, it is not possible to repeat playback the current disc (Repeat Disc mode).
– Pressing the **OPEN•CLOSE** button will cancel all repeat and shuffling modes.

CD Operation

Programming the disc tracks

Programming tracks is possible when playback is stopped. Up to 40 tracks can be stored in the memory in any order.

- 1 Load the desired discs on the disc tray (refer to "Loading discs").
- 2 Press **PROGRAM** to start programming.
→ **PROG** starts flashing.
- 3 Press **CD** or **DISC 1/2/3** to select a disc.
- 4 Press **◀** or **▶** repeatedly to select the desired track.
- 5 Press **PROGRAM** to store the track.
 - Repeat **steps 3–5** to store other discs and tracks.
- 6 To end programming, press **■** **once**.
 - **PROG** stays and the programme mode remains active.
 - The total number of tracks programmed and the total playing time are displayed.
- 7 To start programme play, press **▶||**.
 - "PLAY PROGRAM" is displayed.

Notes:

- If the total playing time is more than "99:59" or if one of the programmed tracks has a number greater than 30, then "- : -" is displayed instead of the total playing time.
- If you attempt to programme more than 40 tracks, "FULL" is displayed.
- If you press any of the CD DIRECT 1/2/3 buttons on the remote control, the system will play the selected disc or track, and the stored programme will be ignored temporarily. The **PROG** symbol also will disappear temporarily from the display. It will reappear when playback of the selected disc ends.
- During programming, if no button is pressed within 20 seconds, the system will exit the programme mode automatically.

To review the programme

- Stop playback and press **◀** or **▶** repeatedly.
- To exit review mode, press **■**.

Erasing the programme

- Press **■** **once** when playback is stopped or **twice** during playback.
→ **PROG** disappears and "PROGRAM CLEARED" is displayed.

Note:

- The programme will be erased when the system is disconnected from the power supply or when the disc tray is opened.

For Recording, please refer to "Tape Operation/Recording".



Radio Reception

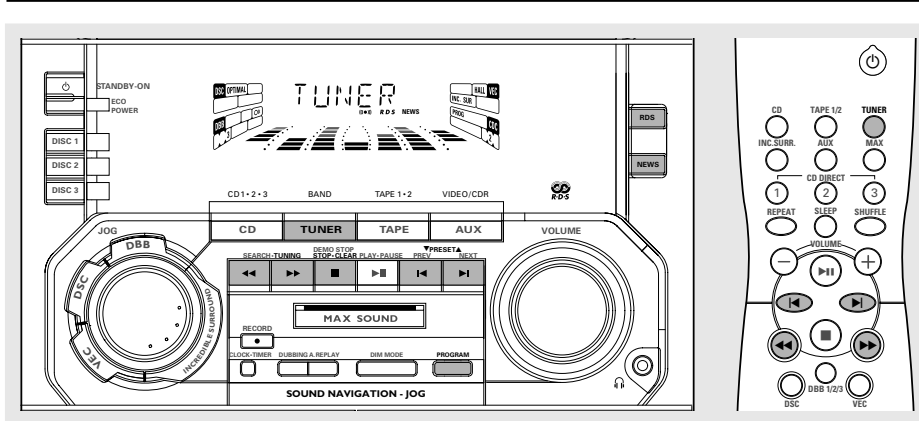

English

Tuning to radio stations

- 1 Press **TUNER** to select TUNER mode.
→ "TUNER" is displayed. A few seconds later, the current radio frequency will appear on the display.
 - 2 Press **TUNER** again to select the desired waveband : FM, MW or LW.
 - 3 Press and hold **◀** or **▶** until the frequency indication starts to change, then release.
→ The display will show "SEARCH" until a radio station with sufficient signal strength is found.
 - 4 Repeat step 3 if necessary until you find the desired radio station.
- To tune to a weak station, press **◀** or **▶** briefly and repeatedly until optimal reception found.

Storing preset radio stations

You can store up to 40 preset radio stations in the memory.

Automatic Preset Programming

- Plug and Play setting (refer to "Basic Functions - Plug and Play").
OR
- 1 Press **TUNER** to select TUNER mode.

To begin automatic preset from a desired preset number

- Press **◀** or **▶** to select the desired preset number.
→ If a radio station has been stored in one of the presets, it will not be stored again under another preset number.
- 2 Press and hold **PROGRAM** until "AUTO" is displayed.
→ **PROG** starts flashing.
→ The system will automatically store the radio stations with sufficient signal strength, starting from all RDS stations and followed by FM, MW and LW bands respectively. Weak RDS stations may be stored in later presets.
→ When all the available radio stations are stored or the memory for 40 presets are used, the last preset radio station (or the first available RDS station) will be played.

To stop storing the automatic preset

- Press **PROGRAM** or **■** on the system.

Note:

– If no preset number is selected, automatic preset will begin from preset (1) and all your former presets will be overridden.

Radio Reception

Manual Preset Programming

- 1 Tune to your desired radio station (refer to "Tuning to radio stations").
- 2 Press **PROGRAM**.
 - **PROG** starts flashing.
 - The next available preset number is displayed for selection.

To store the radio station to another preset number

- Press ◀ or ▶ to select the desired preset number.
- 3 Press **PROGRAM** again to store the radio station.
 - **PROG** disappears.
- Repeat **steps 1–3** to store other radio stations.

To exit manual preset mode

- Press ■ on the system.

Notes:

- If you attempt to store more than 40 preset radio stations, "FULL" is displayed.
- During programming, if no key is pressed within 20 seconds, the system will exit the programme mode automatically.

Tuning to preset radio stations

- Once you've programmed the radio stations, press ◀ or ▶ to select the desired preset number.
 - The preset number, radio frequency, and waveband are displayed.

For Recording, please refer to "Tape Operation/Recording".

RDS

RDS (**R**adio **D**ata **S**ystem) is a broadcasting service that allows FM stations to send additional information along with the regular FM radio signal. This additional information can contain:

Station name: The radio station name is displayed.

Programme type: The following programme types exist and can be received by your tuner: News, Affairs, Info, Sport, Educate, Drama, Culture, Science, Varied, Pop M, Rock M, M.O.R. (middle of the road music), Light M, Classics, Other M, No type.

Radio text (RT): text messages appear on the display.

To receive RDS Radio Stations

- Tuned to a radio station from FM band.
 - If the radio station is transmitting RDS signal, the RDS logo (**rds**) and the radio station name will appear on the display.

To Check the RDS information

- Press **RDS** repeatedly to scroll through the following information (if available) :
STATION NAME → PROGRAMME TYPE →
RADIO TEXT → TUNED FREQUENCY →
STATION NAME

Notes:

- If the tuned radio station does not transmit RDS signal or is a non RDS station, "NO RDS" is displayed.
- If the RDS text message is not available at the RDS station, "NO RDS TEXT" is displayed.



Radio Reception

Setting the RDS clock

Some RDS radio station may be transmitting a real clock time at an interval of every minute. It is possible to set the clock by using a time signal which is broadcast together with the RDS signal.

- 1 Press **CLOCK•TIMER** twice.
- 2 Press **RDS**.
 - "SEARCH RDS TIME" is displayed.
 - When RDS time is read, "RDS TIME" is displayed and the current time will be stored.
 - If the RDS radio station does not transmit RDS time within 90 seconds, "NO RDS TIME" is displayed.

Note:

– Some RDS radio station may be transmitting a real time clock at a minute interval. The accuracy of the transmitted time depends on the transmitting RDS radio station.

NEWS (only available in RDS radio station)

Once the News PTY (Programme Type) is detected in a RDS radio station, it will switch to TUNER mode automatically.

IMPORTANT!

You can activate NEWS function in standby, demonstration or any source mode except Tuner and Eco Power standby mode.

To activate NEWS function

- 1 Press **NEWS** until "NEWS" is displayed.
 - **NEWS** is shown.
 - It will scan the radio stations stored in the first 5 preset and wait for the News Programme Type data to be available in any of these RDS radio stations.
 - While searching NEWS in progress, the current source activity will remain uninterrupted.
- 2 When NEWS transmission is detected, the system will switch to Tuner mode automatically.
 - **NEWS** starts flashing.

Notes:

- You have to exit Tuner mode before selecting NEWS function.
- Before you activate the NEWS feature, ensure that the first five presets have RDS stations.
- The NEWS works only once for each activation.
- The NEWS will not start if a recording is in progress.
- If no RDS station is detected, "NO RDS NEWS" is displayed.

To cancel NEWS function

- Press **NEWS** again or press **TUNER** to select tuner mode.
- During news bulletin, press any other available source keys to execute the relevant source mode.



Tape Operation/Recording

English

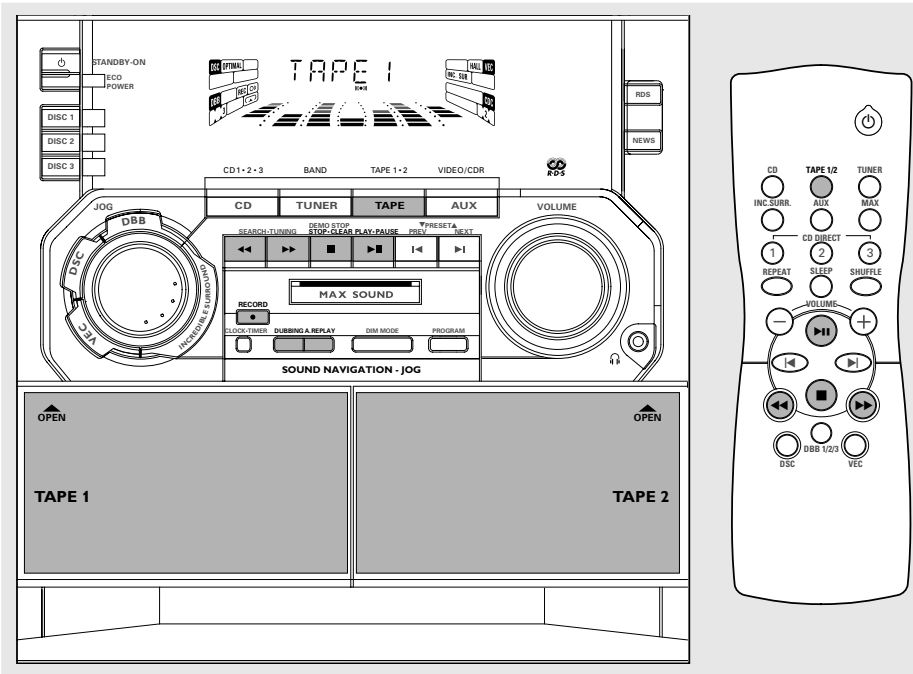

IMPORTANT!

- Before playing a tape, check and tighten slack tape with a pencil. Slack tape may get jammed or may burst in the mechanism.
- C-120 tape is extremely thin and is easily deformed or damaged. It is not recommended for use in this system.
- Store the tapes at room temperature and do not put them too close to a magnetic field (for example, a transformer, TV or speaker).

Loading tape

- 1 Press **OPEN** to open the tape deck door.

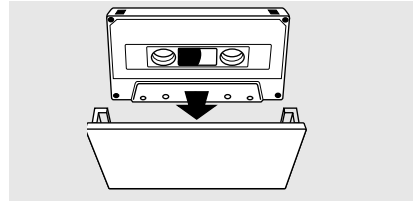

- 2 Load the tape with the open side downward and full spool to the left.
- 3 Close the tape deck door.



Tape Operation/Recording

Playing tapes



To playback a selected tape deck

- 1 Press **TAPE** (or **TAPE 1/2** on the remote control) repeatedly to select tape deck 1 or 2.
- 2 Press **▶II**.

To stop playback

- Press **■**.

To select automatic replay or one time playback

- Press **A. REPLAY** repeatedly to select the different playback modes.
→ "AUTO REPLAY" () or "ONCE" () is displayed.

AUTO REPLAY ...the tape will rewind automatically at the end of playback and replay again. It will replay up to a maximum of 20 times.

ONCE the tape will playback the selected side once and then stop.

Rewinding / Fast forwarding

- 1 Stop playback, press **◀◀** or **▶▶**.
→ The tape will stop automatically at the end of rewinding or fast forwarding.
- 2 Press **■** to stop rewinding or fast forwarding.

Note:

– During rewinding or fast forwarding of a tape, it is also possible to select another source (CD or TUNER, for example).

General information on recording

- For recording, use only tape of IEC type I (normal tape).
- The recording level is set automatically, regardless of the position of the Volume, DBB, DSC and so forth.
- The tape is secured at both ends with leader tape. At the beginning and end of the tape, nothing will be recorded for six to seven seconds.
- To prevent accidental recording, break out the tab on the left shoulder of the tape side you want to protect.
- If "CHECK TAPE" is displayed, the protection tab has been broken. Put a piece of clear adhesive tape over the opening.

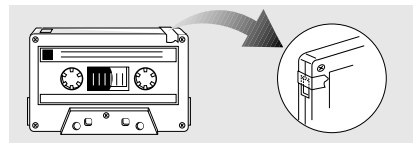
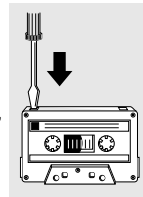

IMPORTANT!

- Recording is permissible if copyright or other rights of third parties are not infringed upon.
- Recording is possible only on tape deck 2.

Tape Operation/Recording

Preparation for recording

- 1 Press **TAPE** to select TAPE 2.
- 2 Load a recordable tape into tape deck 2 with full spool to the left.
- 3 Prepare the source to be recorded.
 - CD** – load the disc(s).
 - TUNER** – tune to the desired radio station.
 - TAPE** – load the prerecorded tape into tape deck 1 with the full spool to the left.
 - AUX** – connect external equipment.

When recording is in progress

→ **REC** starts flashing.

- It is not possible to listen to another source, except tape dubbing.
- It is not possible to activate the timer function during recording or tape dubbing.

One touch recording

- 1 Press **CD**, **TUNER** or **AUX** to select the source.
- 2 Start playback of the selected source.
- 3 Press **RECORD** to start recording.

To stop recording

- Press **■** on the system.

Note:

– One Touch Recording is not possible in TAPE mode, "SELECT SOURCE" is displayed.

CD Synchronised start recording

- 1 Press **CD** to select the disc.
 - Press **◀** or **▶** to select the desired track to start recording.
 - You can programme the tracks in the order you want them to be recorded (refer to "CD Operation - Programming the disc tracks").
- 2 Press **RECORD** to start recording.
 - The disc will start playback automatically.

To select another track during recording

- 1 Press **▶||** to interrupt recording.
- 2 Press **◀** or **▶** to select the desired track.
- 3 Press **▶||** to resume recording.

To stop recording

- Press **■**.
 - Recording and disc playback will stop simultaneously.

Dubbing tapes

- 1 Load the prerecorded tape in tape deck 1.
 - You can set the tape to the desired passage where recording will start.
- 2 Press **DUBBING**.
 - Playing and recording will start simultaneously.
 - "DUBB" is displayed.
 - Dubbing of tapes is possible on one side of the tape only. To continue recording on the reverse side, at the end of side A, flip the tape to side B and repeat the procedure.

To stop dubbing

- Press **■**.

Notes:

- Dubbing of tapes is possible only from tape deck 1 to tape deck 2.
- To ensure good dubbing, use tapes of the same length.



Clock/Timer

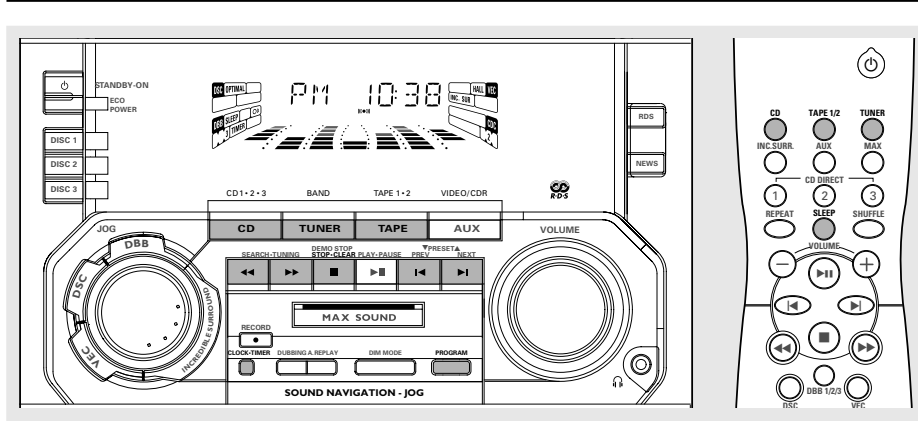

English

IMPORTANT!

When in Eco Power standby mode, it is not possible to operate the clock or timer function.

View clock

The clock (if it is set) will be shown in standby mode.

To view the clock in any source mode (CD or TUNER for example)

- Press **CLOCK-TIMER**.
 - The clock is displayed for a few seconds.
 - If the clock has not been set, "--:--:--" is displayed.

Clock setting

The clock can be set in either 12-hour or 24-hour mode ("PM 12:00" or "00:00" for example)

- 1 In standby or view clock mode, press **CLOCK-TIMER once**. In other source mode, press **CLOCK-TIMER twice**.
- 2 Press **PROGRAM** repeatedly to select clock mode.
 - "PM 12:00" or "00:00" starts flashing.
- 3 Press **◀** or **▶** on the system repeatedly to set the hour.
- 4 Press **◀** or **▶** on the system repeatedly to set the minute.

- 5 Press **CLOCK-TIMER** again to store the setting.
 - The clock starts working.

To exit without storing the setting

- Press **■** on the system.

Notes:

- The clock setting will be cancelled when the power cord is disconnected or if a power failure occurs.
- During clock setting, if no button is pressed within 90 seconds, the system will exit clock setting mode automatically.
- To set the clock automatically through the time information in the RDS signal, refer to "Radio Reception - Setting the RDS clock".



Clock/Timer

Timer setting

The system can switch on to CD, TUNER, or TAPE 2 mode automatically at a preset time, serving as an alarm to wake you up.

IMPORTANT!

- Before setting the timer, ensure that the clock is set correctly.
- The timer will always be switched on after it has been set.
- The timer will not start if a recording is in progress.
- The volume of the timer will increase gradually from the minimum level to the last tuned volume level.

- 1 Press and hold **CLOCK•TIMER** for more than **two seconds** to select timer mode.
 - "FM 12:00" or "00:00" or the last timer setting starts flashing.
 - **TIMER** starts flashing.
 - The selected source will be lighted while other available sources are flashing.
 - 2 Press **CD, TUNER** or **TAPE** to select the desired source.
 - Before setting timer, make sure the music source has been prepared.
 - CD** – Load the disc(s). To start from a specific track, make a programme (refer to "CD Operation - Programming the disc tracks").
 - TUNER** – tune to the desired radio station.
 - TAPE** – load the prerecorded tape into tape deck 2.
 - 3 Press **◀** or **▶** on the system repeatedly to set the hour for the timer to start.
 - 4 Press **⏪** or **⏩** on the system repeatedly to set the minute for the timer to start.
 - 5 Press **CLOCK•TIMER** to store the start time.
 - **TIMER** remains on the display.
 - At the preset time, the selected source will play.
- To exit without storing the setting**
- Press **■** on the system.

Notes:

- When the preset time is reached and the selected disc tray is empty, the next available disc will be selected. If all the disc trays are not available, Tuner will be selected automatically.
- During timer setting, if no button is pressed within 90 seconds, the system will exit timer setting mode automatically.

Deactivating the timer

- 1 Press and hold **CLOCK•TIMER** for more than **two seconds**.
- 2 Press **■** on the system to cancel the timer:
 - "OFF" is displayed and the **TIMER** disappears.

Activating the timer (for the same preset time and source)

- 1 Press and hold **CLOCK•TIMER** for more than **two seconds**.
- 2 Press **CLOCK•TIMER** again to store.
 - **TIMER** is shown.

Sleep timer setting

The sleep timer enables the system to switch to standby mode automatically at a preset time.

- 1 Press **SLEEP** on the remote control repeatedly to select a preset time.
 - The selections are as follows (time in minutes):
15 → 30 → 45 → 60 → OFF → 15 ...
 - "SLEEP xx" or "OFF" is displayed. "xx" is the time in minutes.
- 2 When you reach the desired length of time, stop pressing the **SLEEP** button.
 - **SLEEP** is shown, except for "OFF" mode.
 - The sleep timer is now set. Before the system switches to standby mode, a countdown of 10 seconds is displayed.
"SLEEP 10" → "SLEEP 9" ... → "SLEEP 1"
→ "SLEEP"



Clock/Timer

To check the remaining length of time after sleep timer is activated

- Press **SLEEP** once.

To change the preset sleep timer

- Press **SLEEP** again while the remaining sleep timer is shown.
 - The display will show the next sleep timer options.

To deactivate the sleep timer

- Press **SLEEP** repeatedly until "OFF" is displayed, or press the **STANDBY ON** button.

External Sources

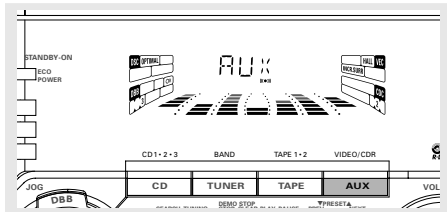

Note:

- All the sound control features (DSC or DBB, for example) are available for selection.
- Refer to the operating instructions for the connected equipment for details.

For Recording, please refer to "Tape Operation/Recording".

Listening to external sources

- 1 Connect the audio out terminals of the external equipment (TV,VCR, Laser Disc player; DVD player or CD Recorder) to the **AUX/CDR IN** terminals of your system.
- 2 Press **AUX** to select external equipment.
 - "AUX" or "CDR" is displayed.



English

Specifications

AMPLIFIER

Output power	2 x 240 W MPO
.....	2 x 120 W RMS ⁽¹⁾
Signal-to-noise ratio	≥ 67 dBA (IEC)
Frequency response	50 – 15000 Hz
Input sensitivity	
AUX/CDR In	500 mV / 1V
Output	
Speakers	≥ 6 Ω
Headphones	32 Ω – 1000 Ω
(1) (6 Ω, 1 kHz, 10% THD)	

CD PLAYER

Number of programmable tracks	40
Frequency response	20 – 20000 Hz
Signal-to-noise ratio	≥ 80 dBA
Channel separation	≥ 60 dB (1 kHz)
Total harmonic distortion	< 0.003%

TUNER

FM wave range	87.5 – 108 MHz
MW wave rang	531 – 1602 kHz
LW wave range	153 – 279 kHz
Number of presets	40
Antenna	
FM	75 Ω wire
AM	Loop antenna

TAPE PLAYER

Frequency response	
Normal tape (type I)	80 – 12500 Hz (8 dB)
Signal-to-noise ratio	
Normal tape (type I)	≥ 48 dBA
Wow and flutter	≤ 0.4% DIN

SPEAKERS

System	3-way; double port bass reflex
Impedance	6 Ω
Woofer	1 x 6.5"
Tweeter	1 x 2.5"
Dimensions (w x h x d) ..	210 x 315 x 235 (mm)
Weight	2.5 kg each

GENERAL

Material/finish	Polystyrene/Metal
AC Power	220 – 230 V / 50 Hz
Power Consumption	
Active	175 W
Standby	≤ 25 W
Eco Power standby	< 1 W
Dimensions (w x h x d) ..	265 x 310 x 381 (mm)
Weight (without speakers)	8.5 kg

Specifications and external appearance are subject to change without notice.



Maintenance

Cleaning the Cabinet

- Use a soft cloth slightly moistened with a mild detergent solution. Do not use a solution containing alcohol, spirits, ammonia or abrasives.

Cleaning Discs

- When a disc becomes dirty, clean it with a cleaning cloth. Wipe the disc from the centre out. Do not wipe in circular motion.
- Do not use solvents such as benzene, thinner, commercially available cleaners, or antistatic spray intended for analogue records.



Cleaning the disc lens

- After prolonged use, dirt or dust may accumulate at the disc lens. To ensure good playback quality, clean the disc lens with Philips CD Lens Cleaner or any commercially available cleaner. Follow the instructions supplied with cleaner.

Cleaning the Heads and the Tape Paths

- To ensure good recording and playback quality, clean the heads (A), the capstan(s) (B), and pressure roller(s) (C) after every 50 hours of tape operation.
- Use a cotton swab slightly moistened with cleaning fluid or alcohol.
- You also can clean the heads by playing a cleaning tape once.

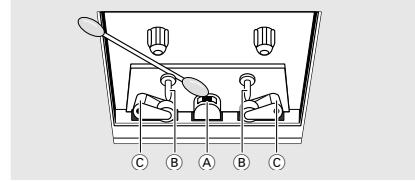

Demagnetising the heads

- Use a demagnetising tape available at your dealer.

Troubleshooting

WARNING

Under no circumstances should you try to repair the system yourself, as this will invalidate the warranty. Do not open the system as there is a risk of electric shock.

If a fault occurs, first check the points listed below before taking the system for repair. If you are unable to solve a problem by following these hints, consult your dealer or service centre.

Problem	Solution
CD OPERATION	
"NO DISC" is displayed.	<ul style="list-style-type: none"> - Insert a disc. - Check if the disc is inserted upside down. - Wait until the moisture condensation at the lens has cleared. - Replace or clean the disc, see "Maintenance".
"DISC NOT FINALIZED" is displayed.	<ul style="list-style-type: none"> - Use a finalised CD-RW or CD-R.





Troubleshooting

RADIO RECEPTION

Radio reception is poor.

- If the signal is too weak, adjust the antenna or connect an external antenna for better reception.
- Increase the distance between the Mini HiFi System and your TV or VCR.

TAPE OPERATION/RECORDING

Recording or playback cannot be made.

- Clean deck parts, see "Maintenance".
- Use only NORMAL (IEC I) tape.
- Apply a piece of adhesive tape over the missing tab space.

The tape deck door cannot open.

- Remove and reconnect the AC power plug and switch on the system again.

GENERAL

The system does not react when buttons are pressed.

- Remove and reconnect the AC power plug and switch on the system again.

Sound cannot be heard or is of poor quality.

- Adjust the volume.
- Disconnect the headphones.
- Check that the speakers are connected correctly.
- Check if the stripped speaker wire is clamped.

The left and right sound outputs are reversed.

- Check the speaker connections and location.

The remote control does not function properly.

- Select the source (CD or TUNER, for example) before pressing the function button (▶, ◀, ▶).
- Reduce the distance between the remote control and the system.
- Insert the batteries with their polarities (+/- signs) aligned as indicated.
- Replace the batteries.
- Point the remote control directly towards the IR sensor.

The timer is not working.

- Set the clock correctly.
- Press and hold CLOCK•TIMER to switch on the timer.
- If recording or tape dubbing is in progress, stop recording.

Not all lighted buttons are showing light.

- Press DIM to select DIM OFF display mode.

The Clock/Timer setting is erased.

- Power has been interrupted or the power cord has been disconnected. Reset the clock/timer.

The system displays features automatically and buttons start flashing.

- Press and hold ■ on the system to switch off the demonstration.