

PHILIPS



México

NOM-135 

Es necesario que lea cuidadosamente su instructivo de manejo.

	PRECAUCIÓN - ADVERTENCIA No abrir, riesgo de choque eléctrico	
	ATENCIÓN Verifique que el voltaje de alimentación sea el requerido para su aparato	
Para evitar el riesgo de choque eléctrico, no quite la tapa. En caso de requerir servicio, dirijase al personal calificado.		

Descripción: **Reproductor de DVD**
Modelo: **DVP 530**
Alimentación: **120 - 230V; ~50-60 Hz**
Consumo: **12W**
Importador: **Philips Mexicana, S.A. de C.V.**
Domicilio: **Av. La Palma No.6,
Col. San Fernando, La Herradura
Huixquilucan, Edo de Mexico
C.P. 52784, Mexico**

Localidad y Tel.: **Tel. 52 69 90 00**

Exportador: **Philips Hong Kong Ltd**
País de Origen: **China**

Nº de Serie: _____

**LEA CUIDADOSAMENTE ESTE INSTRUCTIVO
ANTES DE USAR SU APARATO.**

AVISO IMPORTANTE

Philips Mexicana, S.A. de C.V. no se hace responsable por daños o desperfectos causados por:

- Maltrato, descuido o mal uso, presencia de insectos o roedores (cucarachas, ratones etc.).*
- Cuando el aparato no haya sido operado de acuerdo con el instructivo del uso, fuera de los valores nominales y tolerancias de las tensiones (voltaje), frecuencia (ciclaje) de alimentación eléctrica y las características que deben reunir las instalaciones auxiliares.*
- Por fenómenos naturales tales como: temblores, inundaciones, incendios, descargas eléctricas, rayos etc. o delitos causados por terceros (choques asaltos, riñas, etc.).*



Manufactured under license from Dolby Laboratories. "Dolby", "Pro Logic" and the double-D symbol are trademarks of Dolby Laboratories.

This product incorporates copyright protection technology that is protected by method claims of certain U.S. patents and other intellectual property rights owned by Macrovision Corporation and other rights owners. Use of this copyright protection technology must be authorised by Macrovision Corporation, and is intended for home and other limited viewing uses only unless otherwise authorised by Macrovision Corporation. Reverse engineering or disassembly is prohibited.

Laser safety

This unit employs a laser. Due to possible eye injury, only a qualified service person should remove the cover or attempt to service this device.

NOTE:
PICTURES SHOWN MAYBE DIFFERENT BETWEEN COUNTRIES.

CAUTION
(WARNING LOCATION: ON THE BACKPLATE OF THE SET)
NEVER MAKE OR CHANGE CONNECTIONS WITH THE POWER SWITCHED ON.



LASER

Type	Semiconductor laser GaAlAs
Wave length	650 nm (DVD) 780 nm (VCD/CD)
Output Power	7 mW (DVD) 10 mW (VCD/CD)
Beam divergence	60 degree





General Information

Environmental Information

All unnecessary packaging has been omitted. The packaging has been made easy to separate into three materials: cardboard (box), polystyrene foam (buffer) and polyethylene (bags, protective foam sheet).

Your DVD player consists of materials which can be recycled and reused if disassembled by a specialised company. Please observe the local regulations regarding the disposal of packaging materials, exhausted batteries and old equipment.

Important Note:

Due to the numerous versions of new CD-Audio copy protection or enhanced CD-Audio protection recently available on certain discs, Philips is unable to guarantee that this DVD Player is fully compatible with such new discs. Should you have difficulty playing any such CD-Audio discs, kindly refer them to your CD-Audio disc retailer.

The apparatus shall not be exposed to dripping or splashing and that no objects filled with liquids, such as vases, shall be placed on apparatus.

'CONSUMERS SHOULD NOTE THAT NOT ALL HIGH DEFINITION TELEVISION SETS ARE FULLY COMPATIBLE WITH THIS PRODUCT AND MAY CAUSE ARTIFACTS TO BE DISPLAYED IN THE PICTURE. IN CASE OF 525 OR 625 PROGRESSIVE SCAN PICTURE PROBLEMS, IT IS RECOMMENDED THAT THE USER SWITCH THE CONNECTION TO THE 'STANDARD DEFINITION' OUTPUT. IF THERE ARE QUESTIONS REGARDING OUR TV SET COMPATIBILITY WITH THIS MODEL 525p AND 625p DVD PLAYER, PLEASE CONTACT OUR CUSTOMER SERVICE CENTER.'

For Customer Use:

Read carefully the information located at the bottom of your DVD VIDEO player and enter below the Serial No. Retain this information for future reference.

Model No. DVP 530

Serial No. _____



Index

English 6

Español 33

Português 63

English

Español

Português





Contents

Introduction

Supplied accessories	7
Care and safety information	7

Connections

Connecting TV	8-9
Using Component Video jacks (Y Pb Pr) ..	8
Using Composite Video jack (CVBS)	8
Using S-Video jack	9
Using an accessory RF modulator	9
Connecting the power cord	10
Optional : Connecting to an Audio System .	
.....	11
Stereo system has Dolby Pro Logic or Right	
/ Left Audio In jack	11
Optional: Connecting Digital AV Receiver ...	
.....	11
Receiver has a PCM, Dolby Digital, or	
MPEG2 decoder	11

Functional Overview

Front and Rear Panels	12
Remote Control	13

Getting Started

Step 1: Inserting batteries into the	
Remote Control	14
Using the Remote Control to operate the	
Player	14
Step 2: Setting up the TV	14
Selecting the colour system that	
corresponds to your TV	15
Step 3: Setting language preference	16
Setting the OSD Language	16
Setting the Audio, Subtitle and Disc menu	
language	16

Disc Operations

Playable Discs	17
Playing discs	17
Using the Disc Menu	18
Basic playback controls	18-19
Pausing playback	18
Selecting track/chapter	18
Resuming playback from the last stopped	
point	18
Zoom	18
Repeat	19
Repeat A-B	19
Slow Motion	19
Forward / Reverse Searching	19
Time Search	19

Special DVD features	20
Playing a Title	20
Camera Angle	20
Changing the Audio Language	20
Subtitles	20
Special VCD & SVCD Features	20
Preview	20
Playing MP3/JPEG Picture CD	20-21
General Operation	20
Playback selection	21
Repeat (MP3/JPEG)	21
Program playback	21
Fast forward / reverse	21
Special MP3/JPEG features	21
Preview Function (JPEG)	21
Zoom picture (JPEG)	21
Playback with multi-angles (JPEG)	21

System Menu Options

Basic Operations	22
General Setup Page	22
Program	22
Screen Saver	22
Audio Setup Page	23-25
Speaker Setup	23
Digital Audio Setup	23
Dolby Digital Setup	24
Equalizer	24
3D Processing	25
Video Setup Page	25-27
TV Display	25
Closed Captions	26
Angle Mark	26
Progressive	26
Smart Picture	27
Picture Setting	27
Preference Setup Page	27-28
Parental	27-28
Password	28
Default	28

Specifications

Troubleshooting

Glossary



Introduction

Supplied accessories

Video cable
(yellow)



Audio cable
(white, red)

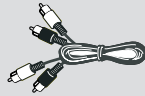

Remote Control
and
two AA batteries

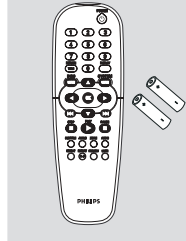

● Avoid high temperatures, moisture, water and dust

– Do not expose the player, batteries or discs to humidity, rain, sand or excessive heat (caused by heating equipment or direct sunlight.)

● Avoid condensation problem

– The lens may cloud over when the player is suddenly moved from cold to warm surroundings, making it impossible to play a disc. Leave the player in the warm environment until the moisture evaporates.

● Do not block the vents

– Do not operate the DVD Player in an enclosed cabinet, allow about 10 cm (4 inches) of free space all around the player for adequate ventilation.

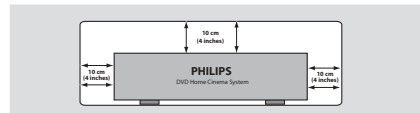

Care and safety information

● Power consumption

– Check that the operating voltage indicated on the typeplate (or beside the voltage selector) is identical to the voltage of your local power supply. If not, please consult your dealer.
– When the system is switched to Standby mode, it is still consuming power. To disconnect the system from the power supply completely, remove the AC power plug from the wall jack.

● Care of the cabinet

– Use a soft cloth slightly moistened with a mild detergent solution. Do not use a solution containing alcohol, spirits, ammonia or abrasives.

● Finding a suitable location

– Place the player on a flat, hard, and stable surface.

● Disc handling

– To clean a CD, wipe it in a straight line from the center towards the edge using a soft, lint-free cloth. A cleaning agent may damage the disc!



– Write only on the printed side of a CDR(W) and only with a soft felt-tipped pen.
– Handle the disc by its edge, do not touch the surface.





Connections

Connecting TV

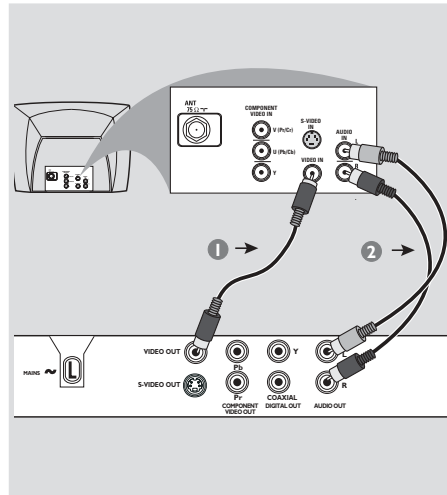
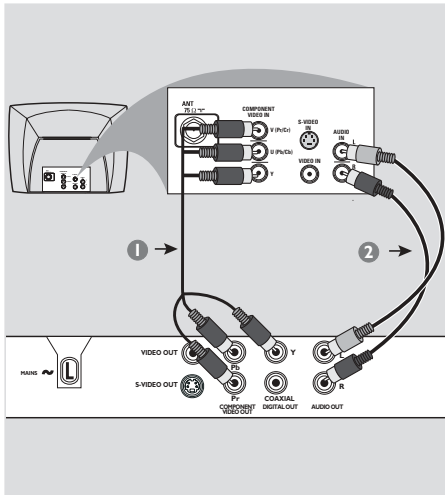

IMPORTANT!

- You only need to make one video connection from the following options, depending on the capabilities of your TV system.
- Connect the DVD system directly to the TV.
- Component Video connection provides highest picture quality. These options must be available on your TV.

Using Component Video jack (Y Pb Pr)

- 1 Use the component video cables (red/blue/green) to connect the DVD Player's Y Pb Pr jacks to the corresponding Component video input jacks (or labeled as Y Pb Pr or YUV) on the TV (cable not supplied).
- 2 To hear the sound of this DVD Player through your TV, use the audio cables (white/red) to connect AUDIO OUT (L/R) jacks of the DVD Player to the corresponding AUDIO IN jacks on the TV (cable supplied).

Using Composite Video jacks (CVBS)

- 1 Use the composite video cable (yellow) to connect the DVD Player's CVBS (VIDEO OUT) jack to the video input jack (or labeled as A/V In, Video In, Composite or Baseband) on the TV (cable supplied).
- 2 To hear the sound of this DVD Player through your TV, use the audio cables (white/red) to connect AUDIO OUT (L/R) jacks of the DVD Player to the corresponding AUDIO IN jacks on the TV (cable supplied).



Connections

English

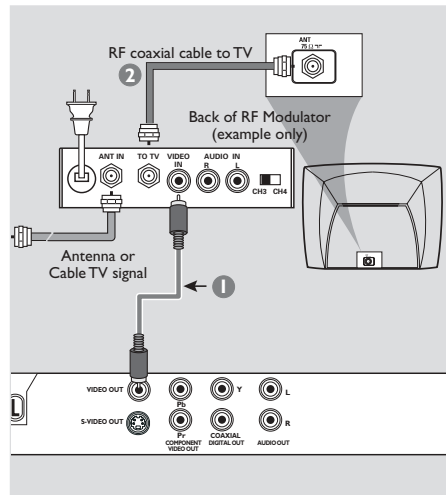
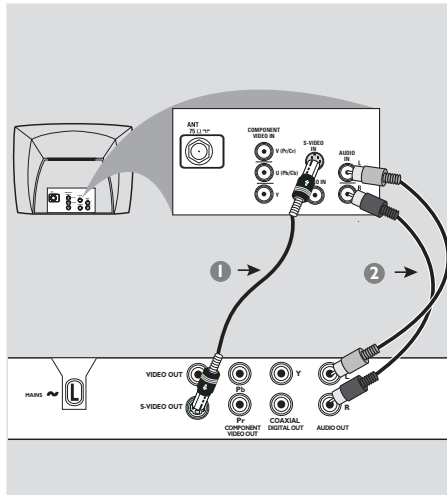

IMPORTANT!

– S-Video connection provides better picture quality. This option must be available on your TV.

Using S-Video jack

- 1 Use the S-video cable to connect the DVD system's **S-VIDEO OUT** jack to the S-Video input jack (or labeled as Y/C or S-VHS) on the TV (*cable not supplied*).
- 2 To hear the sound of this DVD Player through your TV, use the audio cables (white/red) to connect **AUDIO OUT (L/R)** jacks of the DVD Player to the corresponding **AUDIO IN** jacks on the TV (*cable supplied*).

IMPORTANT!

– If your TV only has a single **Antenna In** jack (or labeled as 75 ohm or RF In,) you will need an **RF modulator** in order to view the DVD playback on the TV. See your electronics retailer or contact Philips for details on RF modulator availability and operations.

Using an accessory RF modulator

- 1 Use the composite video cable (yellow) to connect the DVD Player's **CVBS (VIDEO OUT)** jack to the video input jack on the RF modulator.
- 2 Use the RF coaxial cable (not supplied) to connect the RF modulator to your TV's RF jack.



English

Connections

Connecting the power cord

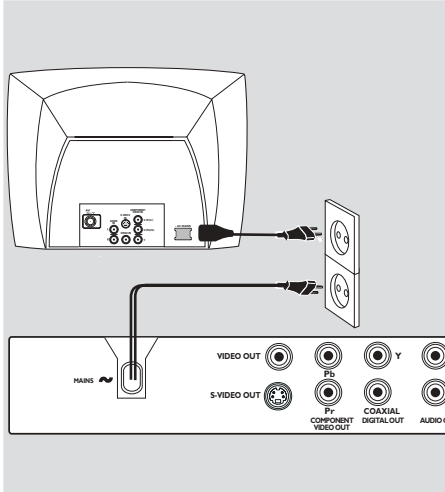

After everything is connected properly, plug in the AC power cord to the power outlet.

Never make or change any connections with the power switched on.

When no disc is loaded, press **STANDBY ON** on the DVD Player front panel, "NO DISC" may appear on the display panel.

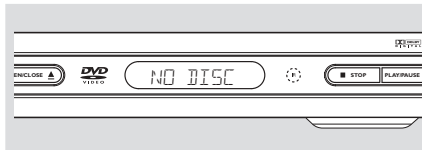



Connections

Optional: Connecting to an Audio System

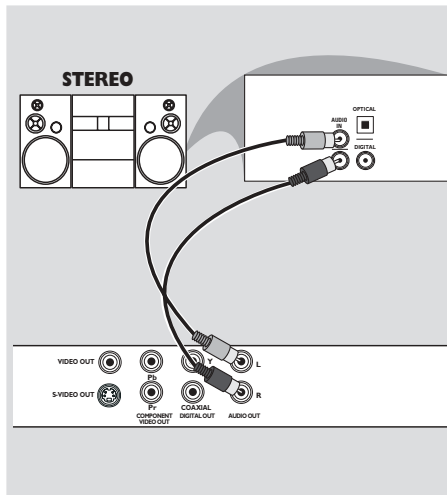

Optional: Connecting Digital AV Receiver

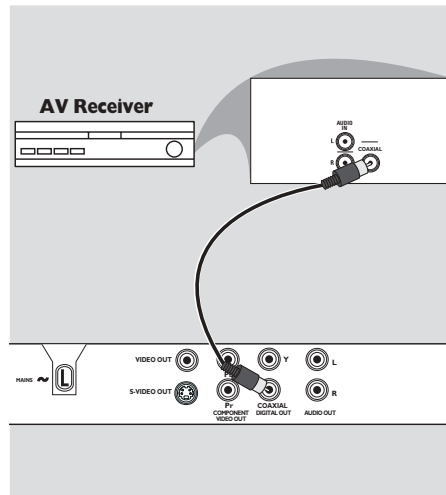

English

Stereo system has Dolby Pro Logic or Right / Left Audio In jack

- 1 Select one of the video connections (VIDEO IN, S-VIDEO IN or Component Video (Y Pb Pr) jack depending on the options available on your TV.
- 2 Use the audio cables (white/red) to connect **AUDIO OUT (L/R)** jacks of the DVD Player to the corresponding AUDIO IN jacks on the stereo system (cable supplied).

Receiver has a PCM, Dolby Digital, or MPEG2 decoder

- 1 Select one of the video connections (VIDEO IN, S-VIDEO IN or Component Video (Y Pb Pr) jack depending on the options available on your TV.
- 2 Connect the COAXIAL jack of the DVD Player to the corresponding Digital Audio In jack on your Receiver (cable not supplied).
- 3 Set the DVD Player's Digital Output to PCM-ONLY or ALL depending on the capabilities of your Receiver (see page 23 "Digital Output").

Helpful Hint:

- If the audio format of the Digital Output does not match the capabilities of your receiver, the receiver will produce a strong, distorted sound or no sound at all.



Functional Overview

English

Front and Rear Panels

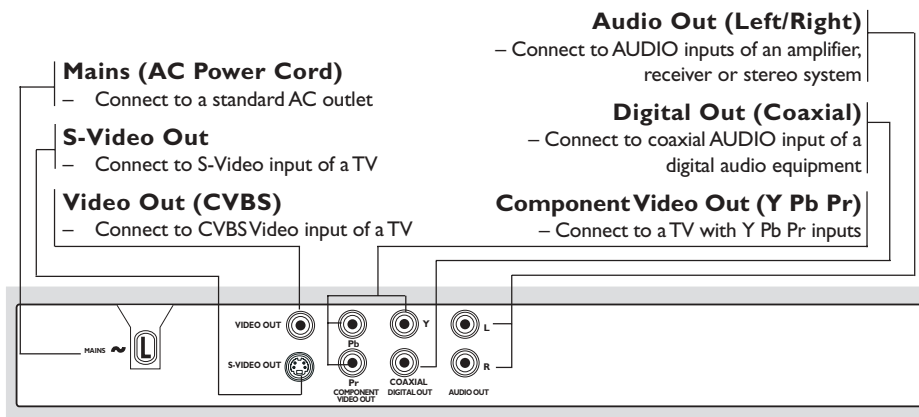
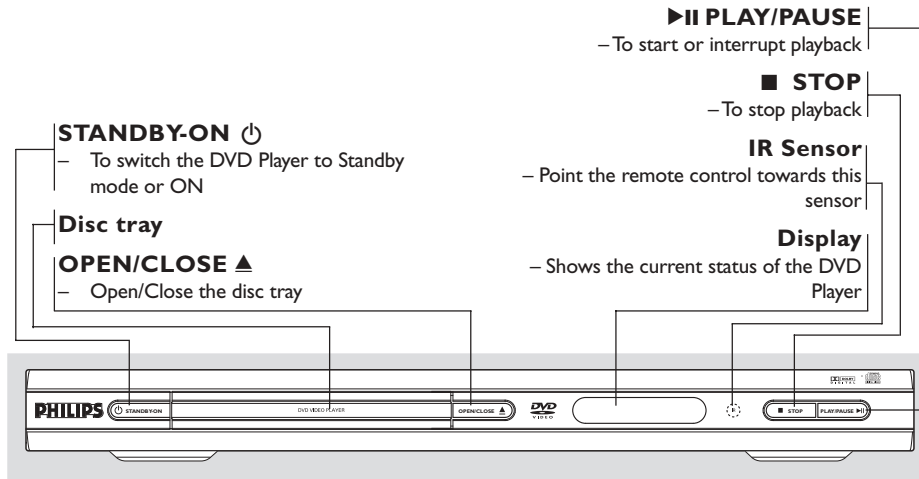

Caution: Do not touch the inner pins of the jacks on the rear panel. Electrostatic discharge may cause permanent damage to the unit.



Functional Overview

Remote Control

English

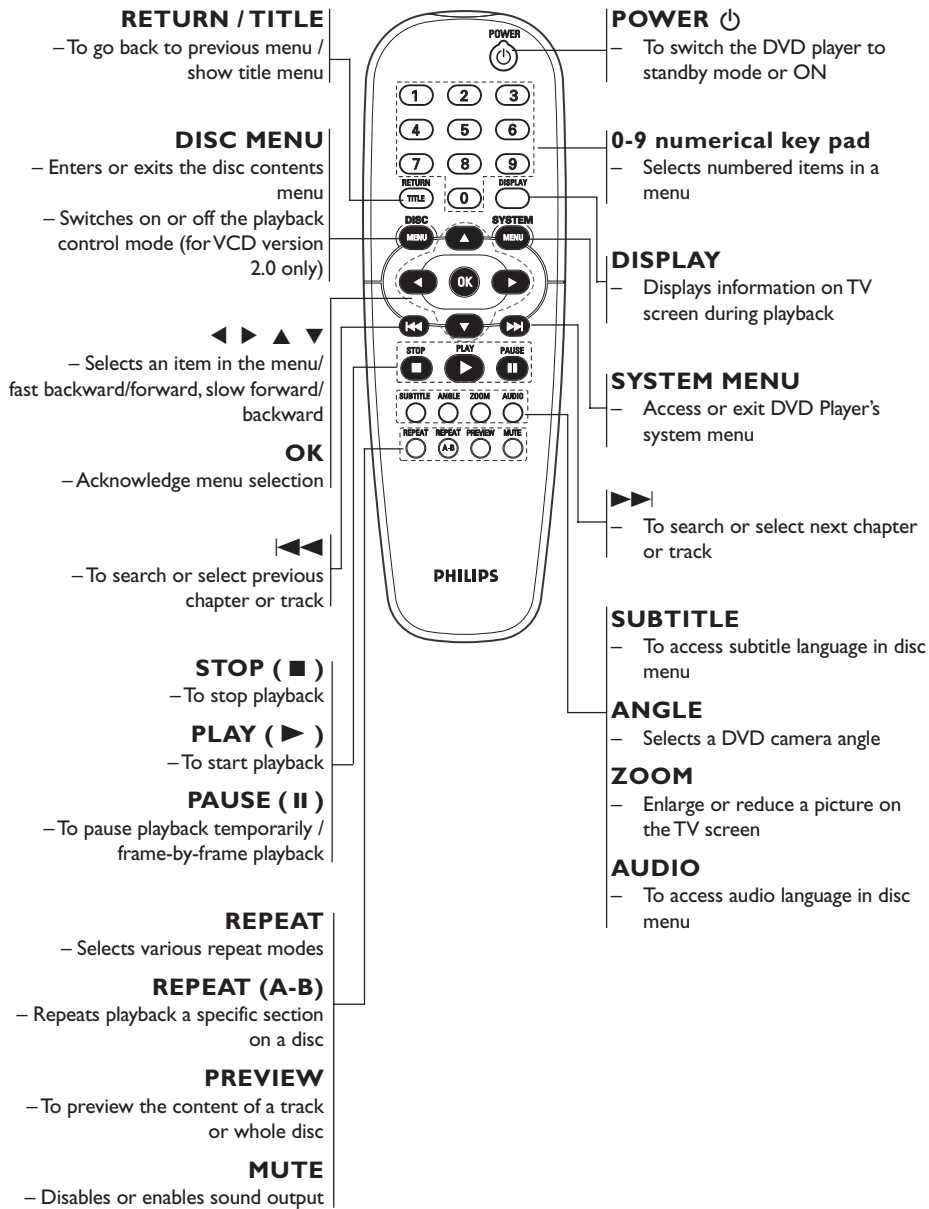



Getting Started

Step 1: Inserting batteries into the Remote Control

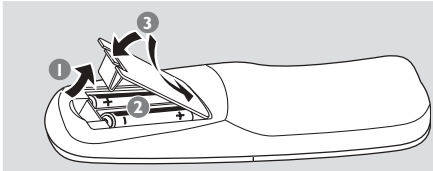

- 1 Open the battery compartment.
- 2 Insert two batteries type R06 or AA, following the indications (+ -) inside the compartment.
- 3 Close the cover.

Using the Remote Control to operate the Player

- 1 Aim the Remote Control directly at the remote sensor (IR) on the front panel.
- 2 Do not put any objects between the Remote Control and the DVD Player while operating the DVD Player.

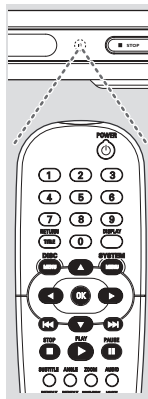

CAUTION!

- Remove batteries if they are exhausted or if the Remote Control is not being used for a long time.
- Do not use old and new or different types of batteries in combination.
- Batteries contain chemical substances, so they should be disposed properly.

Step 2: Setting up the TV

IMPORTANT!

Make sure you have completed all the necessary connections. (See pages 8-9 "Connecting TV").

- 1 Turn on the TV and set to the correct video-in channel. You should see the blue Philips DVD background screen on the TV.
 - Usually these channels are between the lowest and highest channels and may be called FRONT, A/V IN, or VIDEO. See your TV manual for more details.
 - Or, you may go to channel 1 on your TV, then press the Channel down button repeatedly until you see the Video In channel.
 - Or, the TV Remote Control may have a button or switch that chooses different video modes.
 - Or, set the TV to channel 3 or 4 if you are using an RF modulator.
- 2 If you are using external equipment, (eg. audio system or receiver), turn it on and select the appropriate input source for the DVD Player output. Refer to the equipment owner's manual for detail.



Getting Started

Selecting the color system that corresponds to your TV

This DVD Player is compatible with both NTSC and PAL. In order for a DVD disc to play on this Player, the color system of the Disc, the TV and the DVD Player should match.

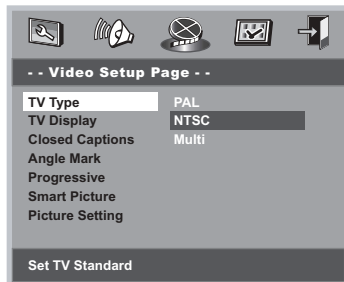

- 1 Press **SYSTEM MENU**.
- 2 Press ◀▶ to select 'Video Setup Page'.
- 3 Use the ◀▶▲▼ keys on the Remote Control to navigate in the menu. Move to 'TV Type' and press ▶.

PAL – Select this if the connected TV is PAL system. It will change the video signal of a NTSC disc and output in PAL format.

NTSC – Select this if the connected TV is NTSC system. It will change the video signal of a PAL disc and output in NTSC format.

Multi – Select this if the connected TV is compatible with both NTSC and PAL (multi-system). The output format will be in accordance with the video signal of the disc.

- 4 Select an item and press **OK**.

Helpful Hint:

- Before changing the current TV Type setting, ensure that your TV supports the 'selected TV Type' system.
- Follow the instructions that appears on the TV screen.
- If there is no proper picture on your TV, wait for 15 seconds for auto recovery.

English

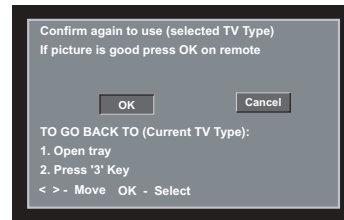
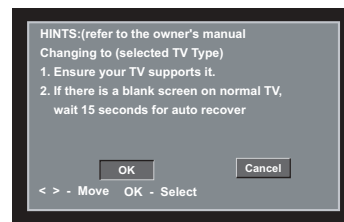

To exit from the menu

Press **SYSTEM MENU** or select 'Exit Setup Menu' and then press **OK**.



Getting Started

English

Step 3: Setting language preference

You can select your own preferred language settings. This DVD system will automatically switch to the selected language whenever you load a disc. If the language selected is not available on the disc, the disc's default language will be used instead. The OSD language in the system menu will remain once selected.

Setting the OSD Language

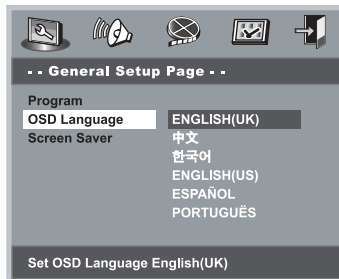

- 1 Press **SYSTEM MENU**.
- 2 Press **◀▶** to select 'General Setup' page.
- 3 Use the **◀▶▲▼** keys on the Remote Control to navigate in the menu. Move to 'OSD Language' and press **▶**.
- 4 Select a language and press **OK**.

To exit from the menu

Press **SYSTEM MENU** or select 'Exit Setup Menu' and then press **OK**.

Setting the Audio, Subtitle and Disc menu language



- 1 Press **STOP** twice then, press **SYSTEM MENU**.
- 2 Press **◀▶** to select 'Preference Page'.
- 3 Press **▲▼** to highlight the following in the Preference Page.
 - 'Audio' (disc's soundtrack)
 - 'Subtitle' (disc's subtitles)
 - 'Disc Menu' (disc's menu)
- 4 Enter its submenu by pressing **▶**.
- 5 Select a language and press **OK**.
- 6 Repeat steps 3~5 for other language settings.

To exit from the menu

Press **SYSTEM MENU** or select 'Exit Setup Menu' and then press **OK**.

If you choose OTHERS in Audio, Subtitle or Disc Menu,

- 1 Press **▲▼** to highlight 'Others'.
- 2 Press **OK** and when you are asked to enter a language code (see 'Language Code' on page 91).
- 3 Input a language code by using the **numeric keypad (0-9)**.
- 4 Press **OK** to confirm.



Disc Operations

IMPORTANT!

- Depending on the DVD or VIDEO CD, some operations may be different or restricted.
- Do not push on the disc tray or put any objects other than disc on the disc tray. Doing so may cause the disc player malfunction.

Playable Discs

Your DVD Player will play:

- Discs:
 - Digital Versatile Discs (DVDs)
 - Video CDs (VCDs)
 - Super Video CDs (SVCDs)
 - Digital Versatile Discs + Recordable (DVD+R)
 - Digital Versatile Discs + Rewritable (DVD+RW)
 - Compact Discs (CDs)
 - MP3 disc on CD-R(W):
 - Maximum 30 characters display.
 - Supported sampling frequencies : 32 kHz, 44.1 kHz, 48 kHz
 - Supported Bit-rates : 32~256 kbps variable bitrates
 - Picture (JPEG) files on CD-R(W):
 - JPEG/ISO 9660 format.



Region Codes

DVDs must be labelled for **ALL** regions or **Region 4** in order to play on this DVD system. You cannot play discs that are labelled for other regions.



Helpful Hint:

- If you are having trouble playing a certain disc, remove the disc and try a different one. Improper formatted disc will not play on this DVD Player.

IMPORTANT!

If the inhibit icon (Ø) appears on the TV screen when a button is pressed, it means the function is not available on the current disc or at the current time.

Playing discs

- 1 Connect the power cords of the DVD Player and TV (and any optional stereo or AV receiver) to a power outlet.
- 2 Turn on the TV power and set to the correct Video In channel. (See page 14 "Setting up the TV").
- 3 Press **STANDBY-ON** on the DVD Player front panel.
 - You should see the blue Philips DVD background screen on the TV.
- 4 Press **OPEN•CLOSE ▲** button to open the disc tray and load in a disc, then press the same button again to close the disc tray.
 - Make sure the label side is facing up. For double-sided discs, load the side you want to play facing up.
- 5 Playback will start automatically (depending on the disc type).
 - If a disc menu appears on the TV, see "Using the Disc Menu".
 - If the disc is locked by parental control, you must enter your four-digit password. (See page 28).
- 6 At any time, simply press **STOP** to stop playback.



Disc Operations

Using the Disc Menu

Depending on the disc, a menu may appear on the TV screen once you load the disc.

To select a playback feature or item

- Use the ◀▶ ▲ ▼ or **numeric keypad (0-9)** on the Remote Control, then press **PLAY ▶** to start playback.

To access or exit from the menu

- Press **DISC MENU** on the Remote Control.

For VCD with Playback Control (PBC) feature (version 2.0 only)

PBC playback allows you to play Video CDs interactively, following the menu on the display.

- In stop mode, use the **numeric keypad (0-9)** to select a track and PBC will turn off.
→ Playback will start automatically
- During playback, press **DISC MENU**;
→ If PBC was ON, it will switch to OFF and continue playback.
→ If PBC was OFF, it will switch to ON and return to menu screen.
- During playback, pressing **RETURN/TITLE** will return to the menu screen (if PBC is on).

Basic playback controls

Unless otherwise stated, all operations described are based on the use of Remote Control.

Pausing playback (DVD/VCD/CD/MP3)

- 1 During playback, press **PAUSE II**.
→ Playback will pause and sound will be muted.
- 2 Press **PAUSE II** again to select the next picture frame.
- 3 To return to normal playback, press **PLAY ▶**.

Selecting track/chapter (DVD/VCD/CD)

- 1 Press ▶▶| briefly during playback to go to the next chapter/track
- 2 Press |◀◀ to go to the previous track (VCD/CD) or return to the beginning of the current chapter (DVD).
- Press |◀◀ twice briefly to step back to the previous chapter (DVD).
- 3 To go directly to any chapter/track, enter the chapter/track number using the numerical keys (0-9).

Resuming playback from the last stopped point (DVD/VCD/CD/MP3)

- In stop mode and when the disc has not been ejected, press **PLAY ▶**.

To cancel resume mode

- In stop mode, press **STOP ■** again.

Zoom (DVD/VCD/JPEG)

Zooming allows you to enlarge or reduce the video image during playback.

- 1 Press **ZOOM** repeatedly to increase and decrease the playback video image.
- 2 Press ◀▶ ▲ ▼ to pan across the TV screen.



Disc Operations

Repeat (DVD/SVCD/VCD/CD)

- Press **REPEAT** continuously to choose a Repeat mode during playback.
 - REPEAT CHAPTER (DVD)
 - to repeat playback of the current chapter.
 - REPEAT TRACK/TITLE (CD/SVCD/VCD/DVD)
 - to repeat playback of the current track (CD/SVCD/VCD)/title (DVD).
 - REPEAT ALL
 - to repeat playback of all the disc and all the programmed tracks.
 - SHUFFLE
 - to repeat playback at random order.
 - REPEAT OFF
 - to cancel the repeat mode.

Helpful Hint:

- *REPEAT function is not available for VCD 2.0 when PCB is on.*

Repeat A-B (DVD/VCD/CD)

- 1 Press **REPEAT A-B** at your chosen starting point.
- 2 Press **REPEAT A-B** again at your chosen end point.
 - The section A and B can be set only within the same chapter/track.
 - The section will now repeat continuously.
- 3 To exit the sequence, press **REPEAT A-B**.

Slow Motion (DVD/VCD)

- 1 Press **▲ ▼** during playback to select the required speed: 1/2, 1/4, 1/8 or 1/16 (backward or forward).
 - Sound will be muted.
- 2 To return to normal speed, press **PLAY ►**.

Helpful Hint:

- *Slow backward is not possible on VCDs.*

Forward / Reverse Searching (DVD/VCD/CD)

- 1 Press **◀ ▶** during playback to select the required speed: 2X, 4X, 8X, 16X or 32X (backward or forward).
 - Sound will be muted (DVD/VCD) or intermittent (CD).
- 2 To return to normal speed, press **PLAY ►**.

Time Search (DVD/VCD)

The Time Search function allows you to start playing at any chosen time on the disc.

- 1 Press **DISPLAY**.
- 2 Press **▲ ▼** to highlight time search box.
 - The on-screen display shows the total playing time of the title/chapter.



- 3 Use **►** keys to select an option.
- 4 Enter hours, minutes and seconds from left to right in the time edit box using remote control numerical key pad. (e.g. 0:34:27)

For DVD

- Title/Chapter Remain: displays the remaining time of the current title/chapter.
- Title/Chapter Elapsed: displays the elapsed time of the current title/chapter.

For Super VCD or VCD

- Total/Single Remain: displays the remaining time of the current total/single track.
- Total/Single Elapsed: displays the elapsed time of the current total/single track.

- 5 Press the **DISPLAY** key to confirm.
 - Playback starts from the selected time on the disc.



Disc Operations

Special disc features

Playing a Title (DVD)

- 1 Press **DISC MENU**.
→ The disc title menu appears on the TV screen.
- 2 Use **▲▼◀▶** keys or **numeric keypad (0-9)** to select a play option.
- 3 Press **OK** key to confirm.

Camera Angle (DVD)

- Press **ANGLE** repeatedly to select different desired angle.

Changing the Audio Language (DVD/VCD)

For DVD

- Press **AUDIO** repeatedly to select different audio languages.

Changing the Audio Channel

For VCD

- Press **AUDIO** to select the available audio channels provided by the disc (STEREO, MONO LEFT, MONO RIGHT or MIX MONO).

Subtitles (DVD)

- Press **SUBTITLE** repeatedly to select different subtitle languages.

Preview Function (DVD/VCD)

The preview function allows you to reduce the picture of 6 tracks enough to display in a full screen.

- 1 Press **PREVIEW**.
→ The preview menu appears on the TV screen.

Select Digest Type:

Title Digest

Chapter Digest

Title Interval

Chapter Interval

(DVD example)

Select Digest Type:

Track Digest

Disc Interval

Track Interval

(Video CD example)

- 2 Press **▲▼** to select the **PREVIEW** type, then press **OK**.
→ The picture of each segment will appear on the screen.

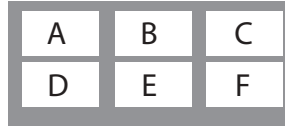

(example for 6 thumbnail pictures display)

- 3 Press **▲▼◀▶** to select a track and input your selected track number using the numeric keypad (0-9), then press **OK**.
→ Playback will start automatically on the selected track.
- For CDDA (Musical CD)
→ Press **PREVIEW** to listen to the first 10 seconds of each sound track in the disc.

Playing MP3/JPEG Picture CD

IMPORTANT!

You have to turn on your TV and set to the correct Video In channel. (See page 14 "Setting up the TV").

General Operation

- 1 Load an MP3/JPEG Picture CD disc.
→ The data disc menu appears on the TV screen.
- 2 Use **▲▼** to select the folder and press **OK** to open the folder.

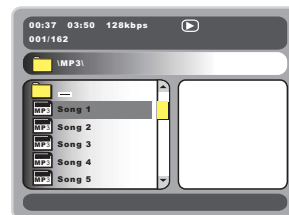

- 3 Press **▲▼** or use the numeric keypad (0-9) to highlight an option.
- 4 Press **OK** to confirm.
→ The playback will start from the selected file to the end of the folder.



Disc Operations

Playback selection

During playback, you can;

- Press **◀◀ / ▶▶** to select another file in the current folder.
- Use **◀▶ ▲▼** on the remote to rotate/flip the picture files.
- Press **||** repeatedly to pause/resume playback.

Repeat

- Press **REPEAT** continuously to access different 'Play Mode'.
 - **SINGLE**: play the selected file once, then return to the menu.
 - **REPEAT ONE**: keep a JPEG image still on the screen or play an MP3 file repeatedly.
 - **REPEAT FOLDER**: play all files in the selected folder repeatedly.
 - **SHUFFLE**: play all files in the selected folder in random order.
 - **FOLDER**: play all files in the selected folder.

Program playback

- In Stop mode, press **DISC MENU** repeatedly to toggle the menu between Folder and Filelist.
- ① When Filelist is on the screen, press **▲▼** to select the files and press **▶** to add the files to the playlist.
- ② Press **DISC MENU** to display the playlist.
- ③ Press **◀** to delete unwanted files from the playlist.

Helpful Hint:

– The disc reading time may exceed 10 seconds due to large number of songs compiled onto the disc.

Fast forward / reverse (MP3)

- During playback, press **◀▶** to fast forward or reverse playback.
- To resume normal playback, press **PLAY ▶**.

Special JPEG features

Preview Function (JPEG)

This function shows the content of the current folder or the whole disc.

- ① Press **PREVIEW** during playback.
 - Thumbnails of 12 pictures appears on the TV screen.
 - (example for 12 thumbnail pictures display)



- ② Press **◀◀ / ▶▶** to display the other pictures on the previous/next page.
- ③ Use **◀▶ ▲▼** to highlight one of the picture and press **OK** to start playback.
- ④ Press **DISC MENU** to return to MP3/ Picture CD menu.

Zoom picture (JPEG)

- During playback, press **ZOOM** repeatedly to display the picture with different scales.
- Use **◀▶ ▲▼** to view the zoomed picture.

Playback with multi-angles (JPEG)

- During playback, press **▲▼◀▶** to rotate the picture on the TV screen.
 - ▲: flip the picture vertically
 - ▼: flip the picture horizontally
 - ◀: rotate the picture anti-clockwise
 - ▶: rotate the picture clockwise





System Menu Options

Basic Operations

- 1 Press **SYSTEM MENU** to enter the Setup Menu.
- 2 Press **OK** to enter the next level submenu or confirm your selection.
- 3 Press **◀▶** to enter the submenu or return to the previous menu.
- 4 Press **▲▼** to highlight the desired menu.

To exit from the menu

Press **SYSTEM MENU** or select 'Exit Setup Menu' and then press **OK**.

→ The settings will be stored in the player's memory even if the player is switched off.

General Setup Page

The options included in General Setup page are: 'Program', 'OSD Language', and 'Screen Saver'.

Follow the steps below:

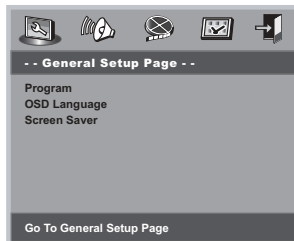

- 1 Press **SYSTEM MENU** to enter the setup menu.
- 2 Press **◀▶** to select the 'General Setup' page.

NOTE:

Some of the features in the System Menu Options are described in "Getting Started".

Program (not for Picture CD/MP3)

To select favourite tracks/chapters playback in preferred sequence.

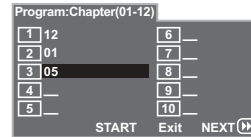

- 1 Use the **numerical keypad (0-9)** to direct input the tracks or chapters (single track number with digit '0' in front, for example '05').
- 2 Move the cursor by pressing **▲▼◀▶** to select **START**.
- 3 Press **OK** to start playback.

Helpful Hint:

– Program can be activated only when a disc is in the DVD player.

Screen Saver

This function is used to turn the screen saver on or off.

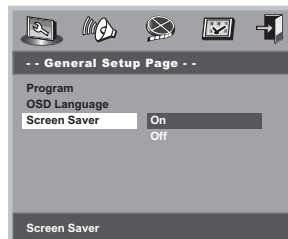

- 1 Press **▲▼** to highlight 'Screen Saver'.
- 2 Enter its submenu by pressing **▶**.
- 3 Move the cursor by pressing **▲▼** to highlight the selected item.
 - **On**: In STOP, PAUSE or No DISC mode, if no actions are performed about 5 minutes, the screen saver will be activated.
 - **Off**: Screen saver is disabled.



System Menu Options

Audio Setup Page

The options included in Audio Setup page are: 'Speaker Setup', 'Digital Audio Setup', 'Dolby Digital Setup', 'Equalizer' and '3D'.

- 1 Press **SYSTEM MENU**.
- 2 Press ◀▶ to select the 'Audio Setup' page.

Speaker Setup

The options included in Speaker Setup are: 'Downmix' and 'D.R.C'.

- 1 Press the ▲▼ keys to highlight an option.
- 2 Enter its submenu by pressing ▶.
- 3 Move the cursor by pressing the ▲▼ keys to highlight the selected item.

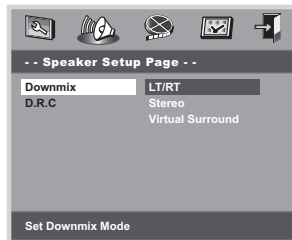

Downmix

This options allows you to set the stereo analog output of your DVD Player.

→ **LT/RT**: Select this option if your DVD Player is connected to a Dolby Pro Logic decoder.

→ **Stereo**: Select this option when output delivers sound from only the two front speakers.

→ **Virtual Surround**: Allows the DVD player to use virtual surround sound effects.

D.R.C (Dynamic Range Control)

Analogue sound dynamic range compression.

→ **On**: Audio with fully compressed dynamic range.

→ **Off**: Audio with uncompressed dynamic range.

→ **Auto**: Select 'Auto' to adjust the dynamic level automatically according to the disc record.

Digital Audio Setup

The options included in Digital Audio Setup are: 'Digital Output' and 'LPCM Output'.

- 1 Press the ▲▼ keys to highlight an option.
- 2 Enter its submenu by pressing ▶.
- 3 Move the cursor by pressing the ▲▼ keys to highlight the selected item.

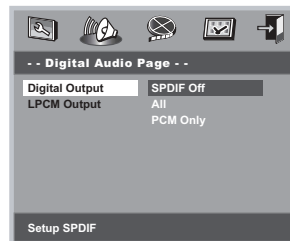

Digital Output

Set the Digital output according to your optional audio equipment connection.

→ **SPDIF Off**: Turn off the SPDIF output.

→ **All**: If you have connected your DIGITAL AUDIO OUT to a multi-channel decoder/receiver.

→ **PCM Only**: Only if your receiver is not capable of decoding multi-channel audio.

Helpful Hint:

– If DIGITAL OUTPUT is set to 'All', all audio settings except MUTE are invalid.

LPCM Output

If you connect the DVD Player to a PCM compatible receiver via the digital terminals, such as coaxial or optical etc, you may need to adjust 'LPCM Output'.

Discs are recorded at a certain sampling rate. The higher the sampling rate, the better the sound quality.

→ **48kHz**: Playback a disc recorded at the sampling rate of 48kHz.

→ **96kHz**: Playback a disc recorded at the sampling rate of 96kHz.

Helpful Hint:

– LPCM Output can be selected only when PCM Only is activated.



System Menu Options

Dolby Digital Setup

The options included in Dolby Digital Setup are: 'Dual Mono' and 'Dynamic'.

- 1 Press the ▲▼ keys to highlight an option.
- 2 Enter its submenu by pressing ►.
- 3 Move the cursor by pressing the ▲▼ keys to highlight the selected item.

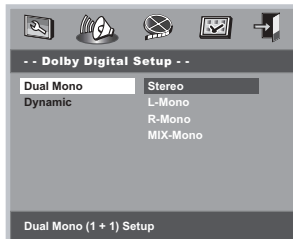

Dual Mono

To select the setting that matches the number of speakers you have connected.

→ **Stereo**: Left mono sound will send output signals to Left speaker and Right mono sound will send output signals to Right speaker.

→ **L-Mono**: Left mono sound will send output signals to Left speaker and Right speaker.

→ **R-Mono**: Right mono sound will send output signals to Left speaker and Right speaker.

→ **Mix-Mono**: Left and Right mixed mono sound will send output signals to Left and Right speakers.

Dynamic

To optimize the dynamic sound output high volume outputs are softened, enabling you to watch your favourite movie without disturbing others.

→ The levels for dynamic selection: Full, 3/4, 1/2, 1/4 and Off.

Helpful Hint:

- DTS surround audio output are not available in this DVD player.

Equalizer

The option included in Equalizer is: 'Sound Mode'.

- 1 Press ▲▼ to highlight 'Sound Mode'.
- 2 Enter its submenu by pressing ►.
- 3 Move the cursor by pressing the ▲▼ keys to highlight the selected item.

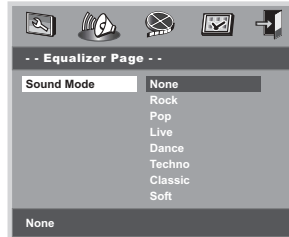

Sound Mode

Select a Sound Mode that matches the type of music you are playing. These preset Sound Modes adjust the frequency bands of the audio to enhance your favorite music.

→ **None, Rock, Pop, Live, Dance, Techno, Classic and Soft**



System Menu Options

3D Processing

The option included in 3D Processing is: 'Reverb Mode'.

- 1 Press ▲▼ to highlight 'Reverb Mode'.
- 2 Enter its submenu by pressing ►.
- 3 Move the cursor by pressing the ▲▼ keys to highlight the selected item.

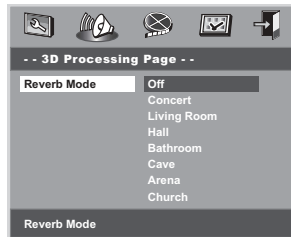

Reverb Mode

Reverb mode provides a virtual surround sound experience using just two speakers.

→ **Off, Concert, Living Room, Hall, Bathroom, Cave, Arena and Church**

Helpful Hint:

- Reverb mode will be activated when 'Downmix' is set to off.

Video Setup Page

The options included in Video Setup page are: 'TV Type', 'TV Display', 'Closed Captions', 'Angle Mark', 'Progressive', 'Smart Picture', and 'Picture Setting'.

- 1 Press **SYSTEM MENU**.
- 2 Press ◀▶ to select the 'Video Setup' page.



TV Display

Set the aspect ratio of the DVD Player according to the TV you have connected.

- 1 Press ▲▼ to highlight 'TV Display'.
- 2 Enter its submenu by pressing ►.
- 3 Move the cursor by pressing ▲▼ to highlight the selected item.

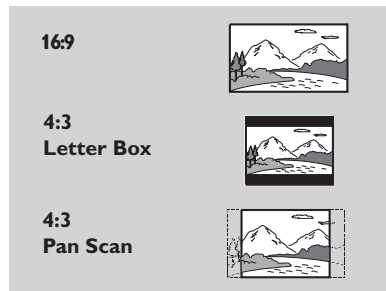

16:9

→ If you have a wide-screen TV.

4:3 Letter Box

→ If you have a normal TV. In this case, a wide picture with black bands on the upper and lower portions of the TV screen will be displayed.

4:3 Pan Scan

→ If you have a normal TV and want both sides of the picture to be trimmed or formatted to fit your TV screen.



System menu Options

English

Closed Captions

Closed captions are data that are hidden in the video signal of some discs. Captions are different from subtitles because captions hearing are impaired by showing the sound effects (e.g., “phone ringing” and “footsteps”), while subtitles do not. Before you select this function, please ensure that the disc contains closed captions information and your TV set also has this function.

- 1 Press ▲▼ to highlight ‘Closed Captions’.
- 2 Enter its submenu by pressing ►.
- 3 Move the cursor by pressing ▲▼ to highlight the selected item.
 - **On**: Enable Closed Captions.
 - **Off**: Disable Closed Captions.

Angle Mark

Displays current angle setting information on the right hand corner of the TV screen if available on the disc.

- 1 Press ▲▼ to highlight ‘Angle Mark’.
- 2 Enter its submenu by pressing ►.
- 3 Move the cursor by pressing ▲▼ to highlight the selected item.
 - **On**: Enable Angle Mark.
 - **Off**: Disable the current angle setting display.

Progressive

This feature is only applicable if you have connected this DVD Player to a Progressive Scan TV through the Y Pb Pr jacks.

- 1 Press ▲▼ to highlight ‘Progressive’.
- 2 Enter its submenu by pressing ►.
- 3 Move the cursor by pressing ▲▼ to highlight the selected item.
 - **On**: Enable Progressive Scan video.
 - **Off**: Disable Progressive Scan video.

Helpful Hint:

- **If a blank/distorted TV screen appears, wait for 15 seconds for auto recover.**
- **Follow the instructions that appears on the TV screen.**

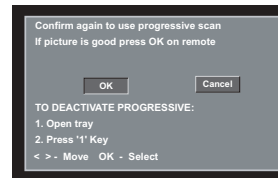
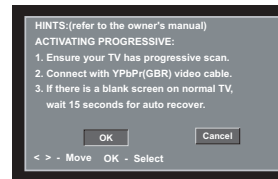



System Menu Options

Smart Picture

In this menu, you can choose a picture setting from a fixed set of predefined picture settings.

- 1 Press **▲▼** to highlight 'Smart Picture'.
- 2 Enter its submenu by pressing **►**.
- 3 Move the cursor by pressing **▲▼** to highlight the selected item.
 - **Standard**: select the standard picture setting.
 - **Bright**: make the TV picture brighter.
 - **Soft**: make the TV picture softer.

Picture Setting

The options included in Picture Setting Setup page are: 'Sharpness', 'Brightness' and 'Contrast'.

- 1 Press the **▲▼** keys to highlight an option.
- 2 Enter its submenu by pressing **►**.
- 3 Move the cursor by pressing the **▲▼** keys to highlight the selected item.



Sharpness

You can personalize your picture colour by adjusting sharpness, brightness or contrast.

- **High**: Choose high to make the picture's edge sharper.
- **Medium**: Choose medium to get a standard picture.
- **Low**: Choose low to make the picture's edge softer.

Brightness/Contrast

Choose a positive value to increase the brightness/contrast level or move to a negative value to decrease the brightness/contrast level.

Preference Setup Page

The options included in Preference page are: 'Audio', 'Subtitle', 'Disc Menu', 'Parental', 'Password' and 'Default'.

- 1 Press **SYSTEM MENU**.
- 2 Press **◀▶** to select the 'Preference Page'.

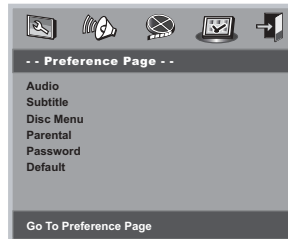

Note:

Preference features can be selected only during 'No Disc' condition or STOP mode.

Parental

Some DVDs may have a parental level assigned to the complete disc or to certain scenes on the disc. This feature lets you set a playback limitation level. The rating levels are from 1 to 8 and are country dependent. You can prohibit the playing of certain discs that are not suitable for your children or have certain discs played with alternative scenes.

- VCD, SVCD, CD have no level indication, so parental control function has no effect on those kinds of discs. This applies to most illegal DVD discs.
- 1 Press **▲▼** to highlight 'Parental'.
 - 2 Enter its submenu by pressing **►**.
 - 3 Use **▲▼** to highlight a rating level for the disc inserted.
 - DVDs that are rated above the level you selected will not play unless you enter your four-digit password and choose a higher level rating.
 - To disable Parental controls and have all Discs play, choose 'Off'.



System Menu Options

Parental - cont'd

Helpful Hint:

- Some DVDs are not encoded with a rating though the movie rating may be printed on the Disc cover. The rating level feature does not work for such Discs.

Rating explanations

1 KID SAFE

- Kids material; recommended especially for children and viewers of all ages.

2 G

- General Audience; recommended as acceptable for viewers of all ages.

3 PG

- Parental Guidance suggested.

4 PG13

- Material is unsuitable for children under age 13.

5-6 PG-R

- Parental Guidance - Restricted; recommended that parents restrict children under 17 from viewing or allow to view only when supervised by a parent or adult guardian.

7 NC-17

- No children under age 17; not recommended viewing for children under age 17.

8 ADULT

- Mature material; should be viewed only by adults due to graphic sexual material, violence or language.

OFF

- It will play all discs.

Password

This feature is used for Parental Control. Enter your four digit password when a hint is displayed on the screen. The default password is 1009.

- 1 Press **▲▼** to highlight 'Password'.
- 2 Enter its submenu by pressing **▶**.
- 3 Press **OK** to open the 'New Password' page.



- 4 Enter the existing 4-digit code.
- 5 Enter the new 4-digit code.
- 6 Enter the new 4-digit code a second time to confirm.
→ The new 4 digit code will be take effect.
- 7 Press **OK** to exit.

Helpful Hints:

- If the password has been changed, the parental and disc lock code will also be changed.
- The default password (1009) is always active even the password has been changed.

Default

Setting the 'Default' function will reset all options and your personal settings to the factory defaults and all your personal settings will be erased.

- 1 Press **▲▼** to highlight 'Default'.
- 2 Highlight **RESET** by pressing **▶**.
- 3 Press **OK** to confirm selection.

Caution!

- **When this function is activated, all settings will be reset to factory defaults.**



Specifications

English

TV STANDARD (PAL/50Hz) (NTSC/60Hz)

Number of lines	625	525
Playback	Multistandard	(PAL/NTSC)

VIDEO PERFORMANCE

DA Converter	12 bit, 54MHz
Component video output (480i/p)	Y: 1Vpp into 75 ohm PbPr: 0.7Vpp into 75 ohm
Video Output	1Vpp — 75 ohm
S-Video Output	Y: 1Vpp — 75 ohm C: 0.3Vpp — 75 ohm

AUDIO FORMAT

Digital	Mpeg compressed Digital
	Dolby Digital 16, 20, 24 bits
	PCM fs, 44.1, 48, 96 kHz
MP3(ISO 9660)	96, 112, 128, 256 kbps & variable bit rate fs, 32, 44.1, 48 kHz

Analog Sound Stereo
Dolby Surround-compatible downmix from Dolby Digital multi-channel sound

AUDIO PERFORMANCE

DA Converter	24 bit, 96mHz
DVD	fs 96 kHz 4Hz- 44kHz fs 48 kHz 4Hz- 22kHz
SVCD	fs 48 kHz 4Hz- 22kHz fs 44.1kHz 4Hz- 20kHz
CD/VCD	fs 44.1kHz 4Hz- 20kHz
Signal-Noise (1kHz)	> 90 dB
Dynamic range(1kHz)	> 80 dB
Crosstalk (1kHz)	> 80 dB
Distortion/noise (1kHz)	> 80 dB
MPEG MP3	MPEG Audio L3

CONNECTIONS

Y Pb Pr output (480i/p)	Cinch 3x (green, blue, red)
S-Video Output	Mini DIN, 4 pins
Video Output	Cinch (yellow)
Audio Output(L+R)	Cinch (white/red)
Digital Output	1 coaxial IEC60958 for CDDA / LPCM IEC61937 for MPEG 1/2, Dolby Digital

CABINET

Dimensions (w x h x d)	360 x 43 x 285 mm
Weight	Approximately 2.0 kg

POWER CONSUMPTION

Power inlet	110 - 127V/ 220-240V, 50-60Hz
Power consumption	12 W
Power consumption in Standby mode	< 1 W

Specifications subject to change without prior notice



Troubleshooting

WARNING

Under no circumstances should you try to repair the system yourself, as this will invalidate the warranty. Do not open the system as there is a risk of electric shock.

If a fault occurs, first check the points listed below before taking the system for repair. If you are unable to remedy a problem by following these hints, consult your dealer or Philips for help.

Problem	Solution
No power	<ul style="list-style-type: none"> – Check if the AC power cord is properly connected. – Press the STANDBY ON on the front of the DVD system to turn on the power.
No picture	<ul style="list-style-type: none"> – Refer to your TV's manual for correct Video In channel selection. Change the TV channel until you see the DVD screen. – Check if the TV is switched on.
Distorted picture	<ul style="list-style-type: none"> – Sometimes a small amount of picture distortion may appear depending on the disc being played back. This is not a malfunction.
Completely distorted picture or black/white picture with DVD	<ul style="list-style-type: none"> – Connect DVD Player directly to the TV. – Make sure the disc is compatible with the DVD Player. – Ensure that the DVD Player's TV Type is set to match that of the Disc and your TV.
No sound or distorted sound	<ul style="list-style-type: none"> – Adjust the volume. – Ensure to select stereo output on your disc (except multichannel). – Check that the speakers are connected correctly. – Ensure that the DTS disc also supports Dolby Digital output.
No audio at digital output	<ul style="list-style-type: none"> – Check the digital connections. – Check if your receiver can decode MPEG-2 or DTS and if not, please make sure the digital output is set to PCM. – Check if the audio format of the selected audio language matches your receiver capabilities.
Disc can't be played	<ul style="list-style-type: none"> – The DVD+R/CD-R must be finalized. – Ensure the disc label is facing up. – Check if the disc is defective by trying another disc. – If you have recorded a Picture CD or MP3 CD yourself, ensure that your disc contains at least 10 pictures or 5 MP3 tracks. – Region code incorrect.
Picture freezes momentarily during playback	<ul style="list-style-type: none"> – Check the disc for fingerprints/scratches and clean with a soft cloth wiping from centre to edge.
No return to start-up screen when disc is removed	<ul style="list-style-type: none"> – Reset the unit by switching the player off, then on again.



Troubleshooting

Problem	Solution
The player does not respond to the Remote Control	<ul style="list-style-type: none">– Aim the Remote Control directly at the sensor on the front of the player.– Reduce the distance to the player.– Replace the batteries in the Remote Control.– Re-insert the batteries with their polarities (+/- signs) as indicated.
Buttons do not work	<ul style="list-style-type: none">– To completely reset the player; unplug the AC cord from the AC outlet for 5-10 seconds.
Player does not respond to some operating commands during playback.	<ul style="list-style-type: none">– Operations may not be permitted by the disc. Refer to the instructions of the disc jacket.
DVD Player cannot read CDs/DVDs	<ul style="list-style-type: none">– Use a commonly available cleaning CD/DVD to clean the lens before sending the DVD Player for repair.
Menu items cannot be selected	<ul style="list-style-type: none">– Press STOP twice before selecting System Menu.– Depending on the disc availability, some menu items cannot be selected.

English

If you are unable to remedy a problem by following these hints, consult your dealer or service center (HOTLINE).

31



Glossary

Analog: Sound that has not been turned into numbers. Analog sound varies, while digital sound has specific numerical values. These jacks send audio through two channels, the left and right.

Aspect ratio: The ratio of vertical and horizontal sizes of a displayed image. The horizontal vs. vertical ratio of conventional TVs is 4:3, and that of wide-screens is 16:9.

AUDIO OUT Jacks: Jacks on the back of the DVD System that send audio to another system (TV, Stereo, etc.).

Bit Rate: The amount of data used to hold a given length of music; measured in kilobits per seconds, or kbps. Or, the speed at which you record. Generally, the higher the bit rate, or the higher the recording speed, the better the sound quality. However, higher bit rates use more space on a Disc.

Chapter: Sections of a picture or a music piece on a DVD that are smaller than titles. A title is composed of several chapters. Each chapter is assigned a chapter number enabling you to locate the chapter you want.

Component Video Out Jacks: Jacks on the back of the DVD System that send high-quality video to a TV that has Component Video In jacks (R/G/B, Y/Pb/Pr, etc.).

Disc menu: A screen display prepared for allowing selection of images, sounds, subtitles, multi-angles, etc recorded on a DVD.

Digital: Sound that has been converted into numerical values. Digital sound is available when you use the DIGITAL AUDIO OUT COAXIAL or OPTICAL jacks. These jacks send audio through multiple channels, instead of just two channels as analog does.

Dolby Digital: A surround sound system developed by Dolby Laboratories containing up to six channels of digital audio (front left and right, surround left and right, center and subwoofer).

JPEG: A very common digital still picture format. A still-picture data compression system proposed by the Joint Photographic Expert Group, which features small decrease in image quality in spite of its high compression ratio.

MP3: A file format with a sound data compression system. "MP3" is the abbreviation of Motion Picture Experts Group 1 (or MPEG-1) Audio Layer 3. By using MP3 format, one CD-R or CD-RW can contain about 10 times as much data volume as a regular CD can.

Multichannel: DVD is specified to have each sound track constitute one sound field.

Multichannel refers to a structure of sound tracks having three or more channels.

Parental Control: A function of the DVD to limit playback of the disc by the age of the users according to the limitation level in each country. The limitation varies from disc to disc; when it is activated, playback will be prohibited if the software's level is higher than the user-set level.

PCM (Pulse Code Modulation): A system for converting analog sound signal to digital signal for later processing, with no data compression used in conversion.

Playback control (PBC): Refers to the signal recorded on video CDs or SVCDs for controlling reproduction. By using menu screens recorded on a Video CD or SVCD that supports PBC, you can enjoy interactive-type software as well as software having a search function.

Progressive Scan: It displays all the horizontal lines of a picture at one time, as a signal frame. This system can convert the interlaced video from DVD into progressive format for connection to a progressive display. It dramatically increases the vertical resolution.

Region code: A system for allowing discs to be played back only in the region designated beforehand. This unit will only play discs that have compatible region codes. You can find the region code of your unit by looking on the product label. Some discs are compatible with more than one region (or ALL regions).

S-Video: Produces a clear picture by sending separate signals for the luminance and the color. You can use S-Video only if your TV has S-video In jack.

Title: The longest section of a picture or music feature on DVD, music, etc., in video software, or the entire album in audio software. Each title is assigned a title number enabling you to locate the title you want.

VIDEO OUT jack: Jack on the back of the DVD System that sends video to a TV.