

1 Connect

Start with the 'Basic connection'.
If you have a VCR, follow the instructions for 'Connection with VCR or similar device'.
If you have a set-top box, follow the instructions for 'Connection with set-top box'.

Basic Connection

A Before Connecting

Unplug the antenna cable that is currently connected to your TV.

If you have only a single off-air antenna, follow 'B1' connection.

If you have both the off-air antenna and digital terrestrial antenna, follow 'B2' connection.

B1 Connecting

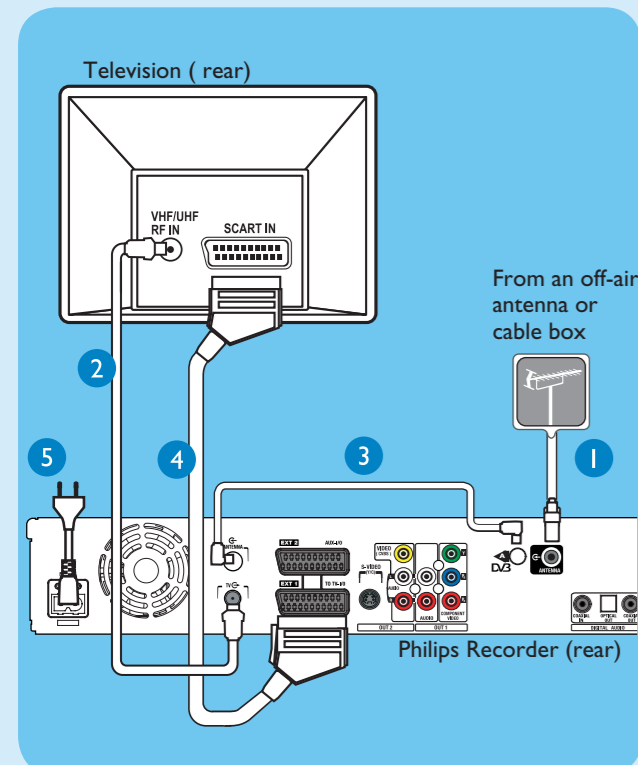

- 1 Disconnect the antenna cable from your TV and connect it to the **ANTENNA** socket on this recorder.
- 2 Use the supplied RF coaxial cable to connect the **TV** socket on this recorder to the Antenna In socket on the TV.
- 3 Use the supplied Tuner interlink cable to connect the two 'A'-sockets on this recorder.
- 4 Use the supplied scart cable to connect the EXT1 TO TV-I/O scart socket on this recorder to the SCART IN socket on your TV.
- 5 Plug in the power cable from the recorder to an AC power outlet.

Note See the accompanying user manual for other possible connections (e.g. S-Video, Component Video)

B2 Connecting (with digital terrestrial antenna)

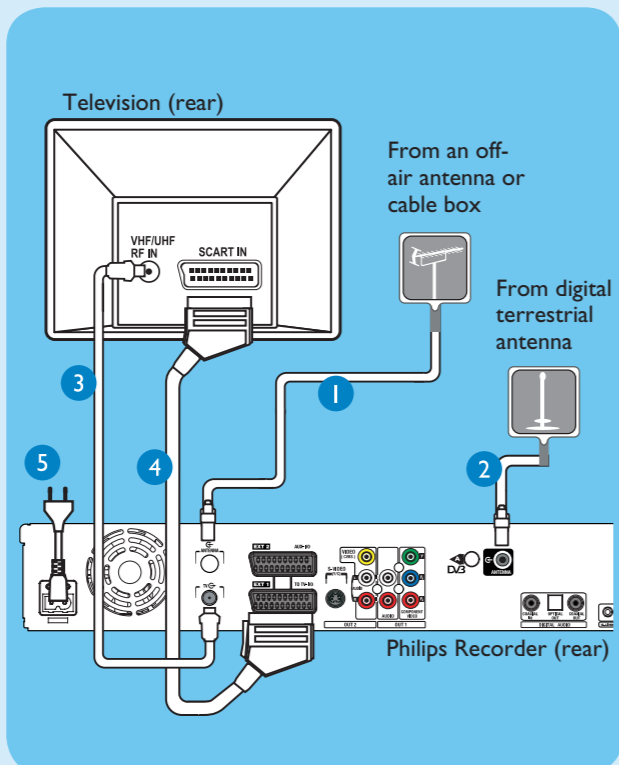

- 1 Disconnect the antenna cable from your TV and connect it to the **ANTENNA** socket on this recorder.
- 2 Connect the indoor DVB-T antenna cable to the **ANTENNA** socket on this recorder.
- 3 Use the supplied RF coaxial cable to connect the **TV** socket on this recorder to the Antenna In socket on the TV.
- 4 Use the supplied scart cable to connect the EXT1 TO TV-I/O scart socket on this recorder to the SCART IN socket on your TV.
- 5 Plug in the power cable from the recorder to an AC power outlet.

Connection with VCR or similar device

A Before Connecting

Your new Philips Recorder replaces the VCR for your recording needs. First, unplug all the connections from your VCR.

B Connecting

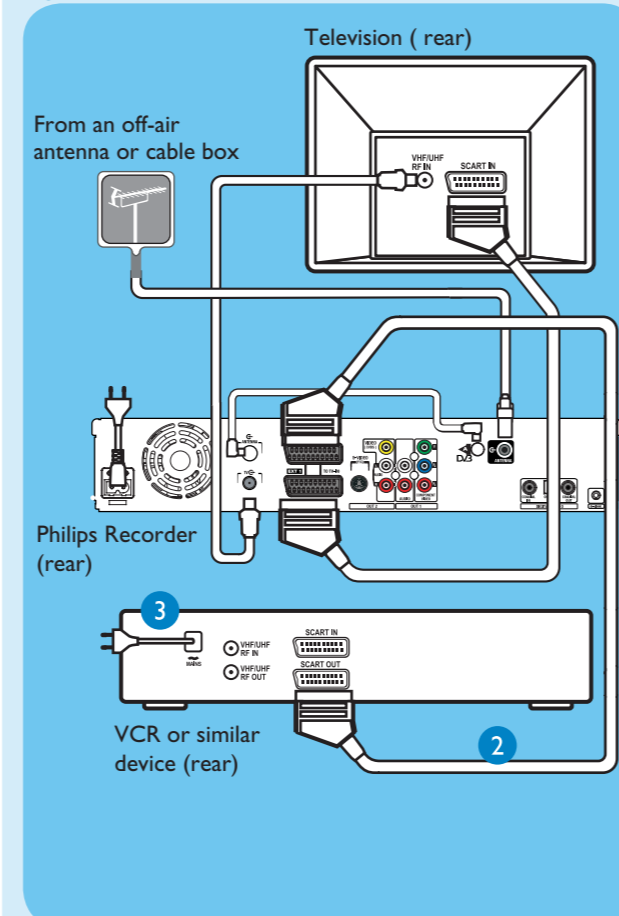

- 1 Follow step 1 to 5 of 'Basic connection' to connect this recorder before you proceed to step 2 below. Above illustration shown the connection without the digital terrestrial antenna.
- 2 Use another scart cable (not supplied) to connect the EXT2 AUX-I/O scart socket on this recorder to the SCART OUT socket on your VCR.
- 3 Connect the power cable from the VCR to an AC power outlet.

Note In this setup, the VCR cannot record TV programmes.

Connection with set-top box

Your new Philips Recorder provides a G-LINK transmitter which allows you to control the tuner of the set-top box (satellite receiver, cable TV box) through the GUIDE Plus+ system. You can record the TV programmes that are received through the set-top box.

Connecting

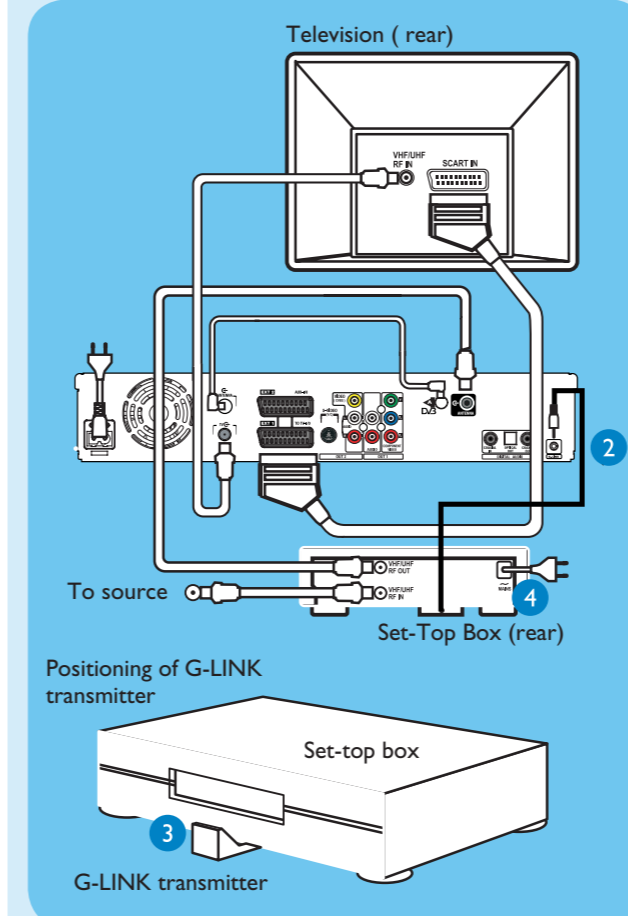

- 1 Follow step 1 to 5 of 'Basic connection' to connect this recorder before you proceed to step 2 below. Above illustration shown the connection without the digital terrestrial antenna.
- 2 Connect the supplied G-LINK cable to the G-LINK socket on this recorder.
- 3 Place the G-LINK transmitter in front of your set-top box in such a way that it can acquire the signal broadcasted by the transmitter.
- 4 Connect the power cable from the set-top box to an AC power cable.

2 Set up

A Finding the viewing channel

- 1 Press **STANDBY-ON** on the recorder. The recorder will display 'IS THE TV ON?'.
- 2 Turn on the TV. You should see the { EASY SETUP } menu.

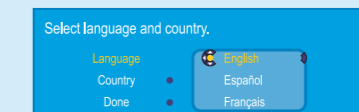

Note If your VCR is connected to this recorder, ensure it is turned off or in standby before proceeding.

- 3 In case you don't see the recorder's setting menu, press the Channel Down button on the TV's remote control repeatedly (or AV, SELECT, - button) until you see the menu. This is the correct viewing channel for the recorder.

B Start basic setup

Use the recorder's remote control and follow the on-screen instructions to complete the installation.

- 1 Select the desired menu language, your country and the TV shape.
- Note** Select { Done } in the menu and press **OK** to go to the next screen.
- 2 Activate automatic channel search for analogue and digital tuner/radio.
- 3 Check the date and time and press **OK**.
- 4 To continue with the GUIDE Plus+ installation, select { Continue } and press **OK**. Otherwise, select { Do not install now } and press **OK**. Wait until the recorder has finished initialising the system, then press **OK** again.

C Install the GUIDE Plus+ system

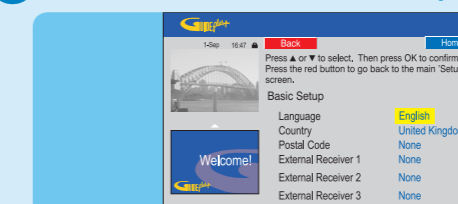

- 1 Follow the on-screen instructions to select your language, country and enter the postal code of your area.
- Note** If no or wrong postal code is entered, it will cause no GUIDE Plus+ (EPG) service information.

D Install the set-top box

If you do not have a set-top box, skip 'D' and go to 'E'.

- 1 Press **down** to select 'External Receiver 1' and press **OK**.
- 2 Press **OK** again to continue.
- 3 Select the type of reception, service provider and brand name of the connected set-top box.

Note Press **OK** to go to the next screen. Select { None } if none of the entries are applicable.

- 4 Select the recorder socket through which your set-top box is connected (e.g. 'EXT2' for EXT2 AUX-I/O socket) and press **OK**.
- 5 Turn on your set-top box and select channel number **02** on the set-top box.
- 6 Read the instructions on the TV and press **OK**.

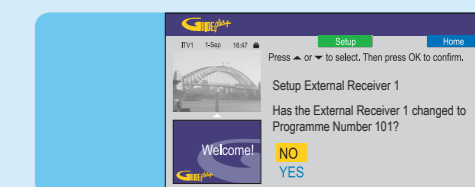

- 7 If the set-top box has switched to the same programme number as displayed on the TV, select { Yes } in the menu and press **OK**.

Note If not, select { No } and press **OK** to try a different code.

- 8 Your set-top box is now installed. Press the **green** button to exit.

Note To switch the GUIDE Plus+ system's host channel manually, go to { Host Channel Setup }.

E Load the TV listing data

- 1 Press **GUIDE** to exit GUIDE Plus+ system. Leave the recorder in 'standby' mode and turn 'on' the set-top box overnight to collect the TV listing data, this may take up to 24 hours.

Note If you tune to your Host Channel before going to 'standby' mode, this recorder will start downloading the TV listings data immediately.

- 2 Check the { Editor } screen the next day to ensure the source and programme numbers are matching for all channels.

3 Enjoy

Quick Start Guide

About the Time Shift Buffer (TSB)

Once you turn on the recorder, the selected TV programme will be stored in a temporary hard disk storage called the 'TSB' (Time Shift Buffer). The 'TSB' can store up to 6 hours of programmes temporarily.

Press **INFO** once to display the Time Shift video bar.

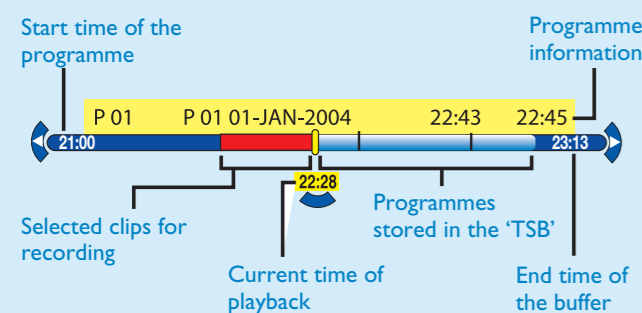

The contents in the time shift video bar will be cleared when you press **STANDBY ON**.

Note A confirmation message for clearing the Time Shift Video bar will be appeared if you press the **CAM** button on the remote control or access the { Setup } or { Record mode } option in the setup menu.

Watch TV – Pause live TV

Your Philips Recorder allows you to control the TV programme. You can **PAUSE** it as if you were in control of the live broadcast.

- 1 Turn on your recorder and press **TUNER** to switch between analogue and digital tuner, then press **CHANNEL +/-** to select a TV programme.
- 2 Press **PAUSE** to suspend it.
- 3 Press **PLAY** to continue.
- 4 Press **TUNER** to return to the live broadcast.

Help text information bar

[PLAY] [BACK] [BROWSER]

The help text bar located at the bottom of the screen is providing the information on:

- remote control keys that can be used at the current state.
- brief information of the selected item.

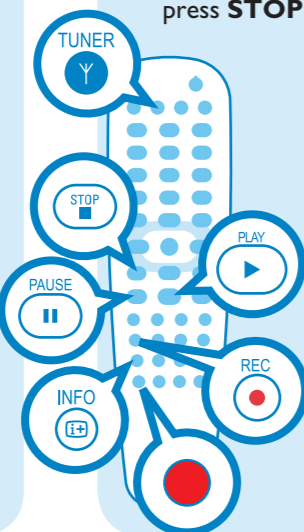

Record to hard disk

A Contents in the temporary HDD storage

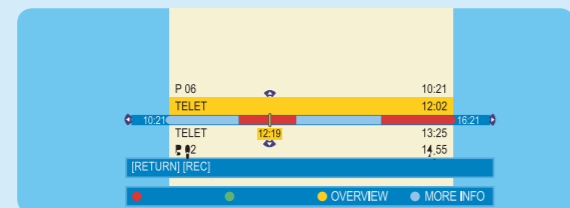

- 1 Press **INFO** to view what is temporarily stored in the hard disk storage.
- 2 Press **▲ up** or **▼ down** to choose the title you want to record.
- 3 Press **SEARCH** to search for the scene where you want to start recording, then press the **red** button.

Note Pressing the **red** button again will cancel the recording.

- 4 Press **STOP** to end the recording.

Note The title will be marked in red and the recording will only take effect when you turn off the recorder.

B Current TV programme

- 1 Press **REC** to start recording. It can record up to 6 hours.

Note To set the recording time, press repeatedly to extend the recording time in 30-minute increments, up to 6 hours. In the countries where no GUIDE Plus+ TV listing data is available, recording will start from the beginning of the current viewing channel onwards.

- 2 To stop the recording before the scheduled time, press **STOP**.

Start playback

A From the hard disk

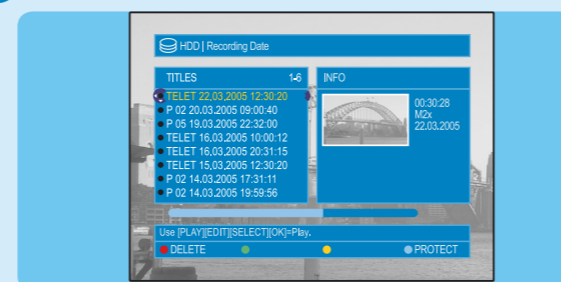

- 1 Press **HDD-BROWSER**, then press **▶ right** until you see the { TITLES } and { INFO } menus.
- 2 Press **▲ up** or **▼ down** to select a title.
- 3 Press **PLAY** to start playback.

B From a disc

- 1 Hold down **STOP** until the disc tray opens. Load a disc and close the disc tray.

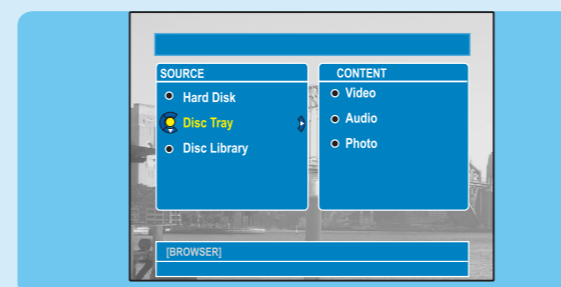

- 2 Press **HDD-BROWSER** to go to the content menu. Select { Disc Tray } and press **▶ right** until you see the { TITLES }, { TRACKS } or { PHOTO ROLLS } menu, depending on the disc type.
- 3 Press **▲ up** or **▼ down** to select a title.
- 4 Press **PLAY** to start playback.

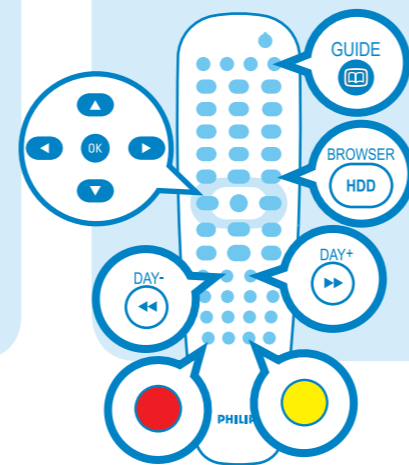

Using the GUIDE Plus+ system

Make sure that the analogue tuner installation and TV listing data download is completed.

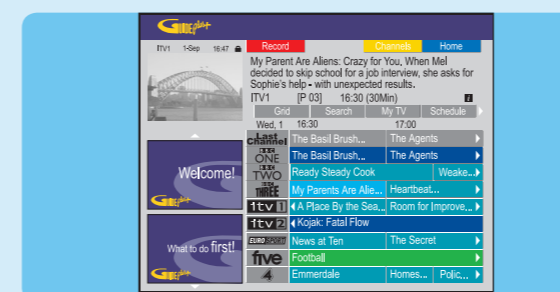

Record TV programmes

- 1 Press **GUIDE**.
- 2 Press **▼ down** to select a TV channel.
- 3 Press **◀ left** or **▶ right** to select a TV programme.
- 4 Press the **red** button to set the highlighted programme for recording.

Note Press the **yellow** button to see an overview of all the available channels and choose from there.

Note Press **DAY- / DAY+** to go directly to a day before or the next day TV listings.

Note You can store up to 25 programmes for recording.

Need help?

GUIDE Plus+ system
Go to www.europe.guideplus.com

User Manual
See the user manual that came with your Philips Recorder

Online
Go to www.philips.com/support

Be responsible
Respect copyrights

PHILIPS 2006 © Koninklijke Philips N.V.
All rights reserved.
12 NC 3139 245 25151
www.philips.com



- 1 Connect
- 2 Set up
- 3 Enjoy

What's in the box?

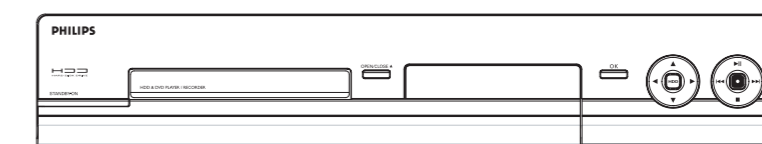

HDD & DVD Player / Recorder

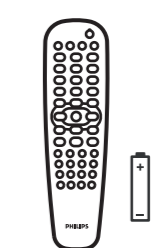

Remote Control and 2 batteries

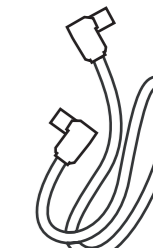

Tuner interlink cable

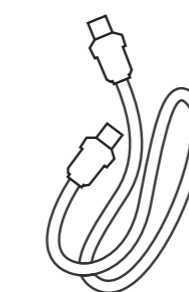

RF coaxial cable

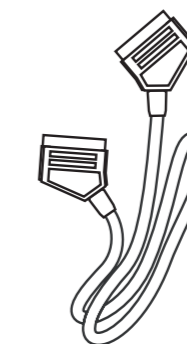

Scart cable

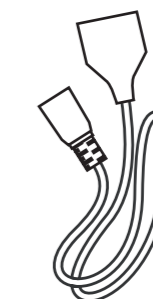

Power cable

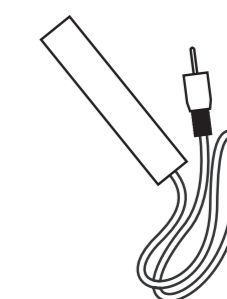

G-LINK cable & transmitter

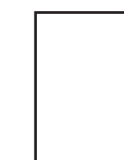

User Manual

PHILIPS