

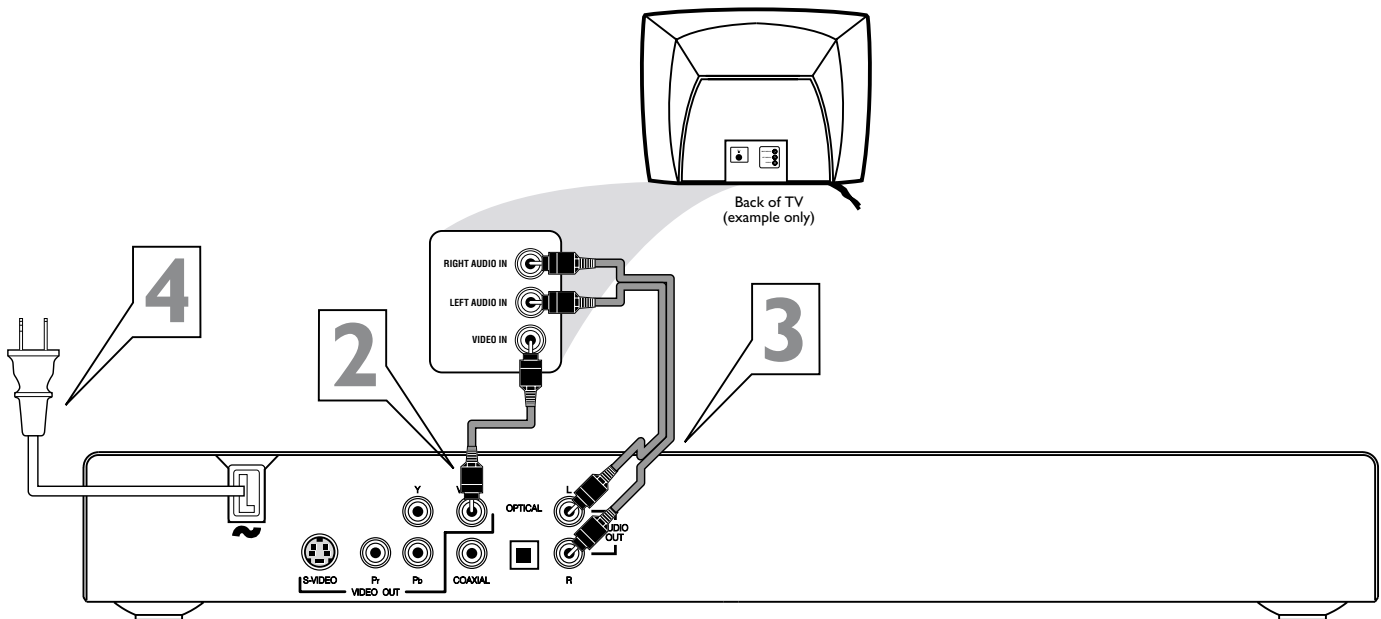

# QUICK-USE GUIDE

There are many ways to connect your new DVD Player to your Television and other equipment. This Quick-Use Guide shows the easiest, most common connection between the DVD Player and a TV using the supplied cables. Higher quality connections are explained in the accompanying owner's manual and will provide better sound or picture if your TV and/or audio system is compatible.



- 1 Disconnect all equipment from the power outlets.** Connect the equipment to the power outlets only after you have finished hooking up everything. Never make or change connections with equipment connected to the power outlet.
- 2 Connect the Player's yellow VIDEO (VIDEO OUT) jack to the corresponding VIDEO IN jack on your TV.** Use the supplied video cable, which has yellow ends. On the TV, the Video In jack is usually yellow and might be labeled video, CVBS, composite, or baseband.
- 3 Connect the supplied audio cable to the AUDIO OUT (left and right) jacks on the DVD Player and to the left/right AUDIO IN jacks on the TV.** The supplied audio cable has red and white ends. Match the cable colors to the jack colors. On the TV, the Audio In jacks are usually labeled Audio. The red jack is the right (stereo channel) and the white jack is the left (stereo channel).
- 4 Plug the power cords of the DVD Player and the TV into an active power outlet. Press STANDBY-ON  on the front of the Player to turn it on.**
- 5 Turn on the TV power and set it to the correct Video In channel.** Such channels may be called AUX or AUXILIARY IN, AUDIO/VIDEO or A/V IN, EXT1 or EXT2 or External In, etc. These channels are often near channel 00, or your TV's remote may have a button or switch that selects a Video channel. See your TV manual for details. Or, go to your lowest TV channel (01 or 02), then change TV channels downward until you see the blue DVD screen on the TV.

## Remember...

- Connect the DVD Player directly to the TV. For example, do not connect the Player to a VCR, then connect the VCR to a TV. This type of connection may distort the picture and sound or give you a black and white picture. Also, your VCR might have the copy protection system, which could distort the DVD image or prevent playback of some Discs.
- If your TV does not have red, white, and yellow Audio and Video In jacks, see the DVD Player's owner's manual for other hookup options. If your TV only has a single Antenna In or RF In jack, you will need an RF modulator. See the owner's manual for details.
- If a DVD does not play properly, please contact Philips at 1-800-531-0039 for assistance. Due to the inconsistency of Disc formats provided by various Disc manufacturers, your DVD Player may require a playability enhancement. As DVD technology has advanced, these enhancements have become both common and easy to complete.







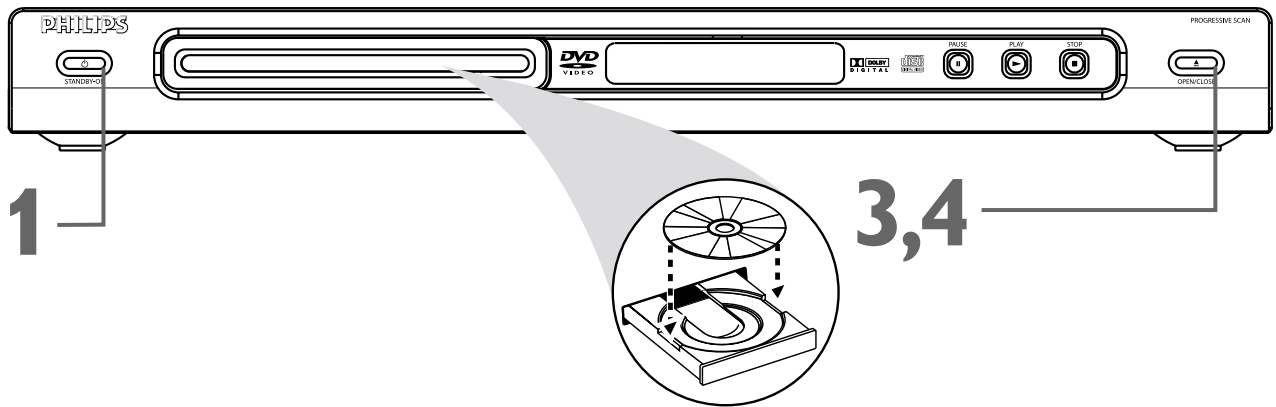





# PHILIPS

# QUICK-USE GUIDE



To simply play a Disc, follow these steps. Additional features are described in the accompanying owner's manual.

- 1** Press **STANDBY-ON**  on the front of the Player to turn it on. Or, press **POWER**  on the remote.
- 2** Turn on your TV. Set it to the correct **Video In** channel. You should see the blue DVD screen on the TV (if no Disc is in the Player).
- 3** Press **OPEN/CLOSE**  on the front of the Player to open the disc tray.
- 4** Load your Disc in the tray, with the label facing up, and the shiny side facing down. If the Disc (DVD) is two-sided, make sure the label of the side you want to play is facing up. Press **OPEN/CLOSE**  again to close the tray.
- 5** Play may start automatically. If not, press **PLAY** . If a Disc menu appears, use the , , , and  buttons or the Number buttons to select features or start playback from a menu. Follow the instructions in the Disc menu.
- 6** To stop playing the Disc, press **STOP** .

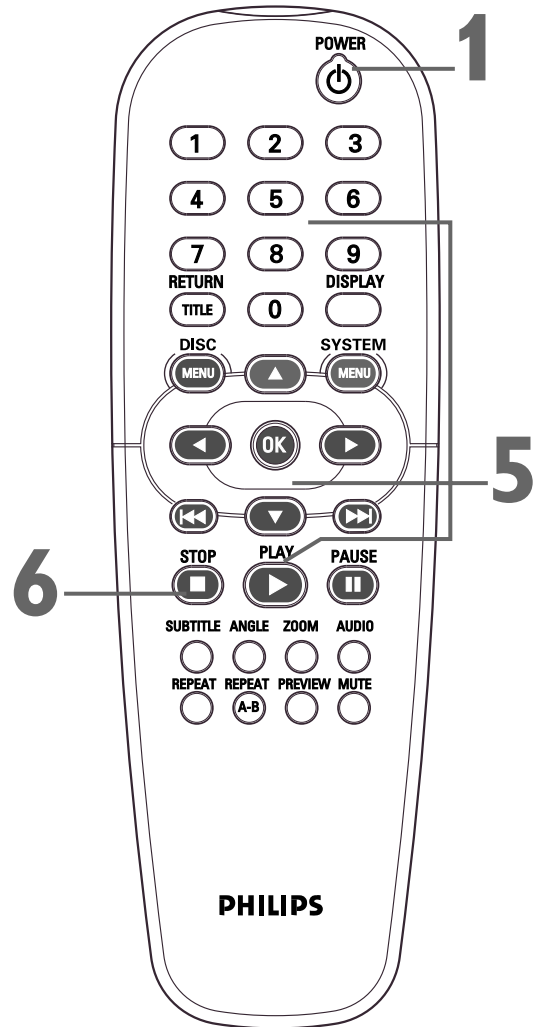

## Playable Discs

This DVD Player will play the following types of Discs:



## Region Codes

DVDs must be labeled for ALL regions or for Region 1 in order to play on this DVD Player. You cannot play Discs that are labeled for other regions. If one of these logos appears on your DVD or its case, it should play on this Player.



## Color Systems

Recordings are made according to a color system. The most common color system in the United States is NTSC. This Player is compatible with **NTSC** and **PAL**. Make sure the Discs you play were recorded in NTSC or PAL and your TV is NTSC or PAL compatible. Look for the color system of the DVD on the DVD or on the Disc case. Set the Player's TV TYPE accordingly. See the owner's manual for details.